

Expert Solutions for Inhaler Testing

*Helping Scientists
Improve People's Lives*



METERED-DOSE INHALERS • DRY POWDER INHALERS • NEBULISERS
SOFT MIST INHALERS • NASAL PRODUCTS

COPLEY



About Us

Helping Scientists Improve People’s Lives for Over 80 Years

Founded in 1946 and headquartered in Nottingham, UK, Copley Scientific remains a family-owned and managed company. For over 80 years, the company has helped scientists worldwide generate reliable data that supports the development and quality of inhaled medicines.

Recognised as the global leader in inhaler testing, Copley delivers more than precision instruments. The company provides a connected ecosystem designed to support modern laboratory workflows, combining advanced hardware with software-enabled data management to improve traceability, consistency and confidence in analytical results.

Through integrated automation solutions, Copley helps laboratories strengthen data accuracy, repeatability and integrity, while reducing the risks associated with manual processes and supporting streamlined testing programmes.

Copley’s commitment extends beyond equipment supply, with expert training, qualification services and ongoing maintenance support to help ensure continued performance and audit-readiness. Software-enabled workflows, help laboratories maintain compliance, readiness and confidence in critical testing systems.

These commitments are exemplified through continuous improvement and certification to the ISO 9001:2015 Quality Management System across all aspects of the business, including equipment design and manufacture.

Copley customers benefit from:

- End-to-end orally inhaled and nasal drug product testing solutions supporting accurate and compliant data
- Integrated digital data management for traceability and workflow efficiency
- Automation technologies that enhance repeatability and data integrity
- Expert training, qualification and ongoing maintenance support

“Our vision is to help scientists around the world improve the quality of people’s lives.”

Copyright

This edition of the Copley Scientific Limited brochure is copyright 2026. All rights reserved.

No portion of this brochure may be reproduced without the permission of Copley Scientific Limited. Copley Scientific Limited reserves the right to make changes without notice to any products herein to improve reliability or design.

Copley Scientific Limited does not assume any liability arising out of the application or use of any product described herein. Neither does it convey any licence under its patent rights nor the rights of others.

Any third party documentation or organisation mentioned herein is referential only and implies no company or affiliation with, Copley Scientific Limited.

Trademark notice

Copley Scientific, the Copley Scientific logo and all other registered trademarks are registered trademarks of Copley Scientific Ltd. in the UK and other jurisdictions.

Issue: v26.1

The Copley Promise



Innovative

Novel solutions that maximise understanding and productivity.

Compliant

Certified to the standards defined by global regulators and pharmacopoeias.

Trusted

Quality products with accuracy, robustness and reliability built-in.

Contents

Introduction 2

- About Us 2
- ISO 9001: 2015 Quality Management System 2
- The Copley Promise 3

Table of Contents 4

Orally Inhaled & Nasal Drug Products (OINDPs) 6

- Orally Inhaled Drug Products 7
- Metered-Dose Inhalers (MDIs) 7
- Dry Powder Inhalers (DPIs) 8
- Nebulisers 9
- Soft Mist Inhalers (SMIs) 10
- Nasal Drug Products 10
- Applications of OINDPs 11

Organisations and their Roles 12

- Regulatory Bodies in the UK, European Union, China, Japan and USA 12
- International Regulation and Harmonisation 14
- Drug Safety, Quality and Efficacy - The Pharmacopoeias 15
 - European Pharmacopoeia (Ph. Eur.) 15
 - United States Pharmacopoeia (USP) 15
 - Chinese Pharmacopoeia (ChP) 16
 - Japanese Pharmacopoeia (JP) 16
- Device Safety, Quality and Efficacy - International Standards Organisation (ISO) 16
- Expert Groups 16
 - European Pharmaceutical Aerosol Group (EPAG) 16
 - International Pharmaceutical Consortium on Regulation and Science (IPAC-RS) 16
 - Product Quality Research Institute (PQRI) 16
- Organisational Chart: Guidelines and Regulations 17

Delivered Dose Uniformity 18

- Background 18
- DDU Over the Entire Contents 19
- Collection Devices for DDU Testing 20
 - For MDIs, DPIs, BAIs and SMIs 20
 - Dose Collection 20
 - Waste Shot Collection 24
- For MDIs with Spacers/VHCs 25
- For Nasal Sprays, Nasal Aerosols and Nasal Powders 26
 - Dose Collection 26
 - Waste Shot Collection 29
- USP Monographs 31
- Delivered Dose Uniformity Testing of:
 - Metered Dose Inhalers (MDIs) 32
 - MDIs with a Spacer/VHC 40
 - Dry Powder Inhalers (DPIs) 46
 - Nebulisers 52
 - Soft Mist Inhalers (SMIs) 58
 - Nasal Sprays 64
 - Nasal Aerosols 68
 - Nasal Powders 72

Aerodynamic Particle Size Distribution 78

- Background 78
- An Introduction to Cascade Impaction 79
- How Does a Cascade Impactor Work? 82
- Types of Cascade Impactor 84
 - Next Generation Impactor (NGI) 84
 - Andersen Cascade Impactor (ACI) 90
 - Multi-Stage Liquid Impinger (MSLI) 96
 - Glass Twin Impinger (GTI) 100
- Aerodynamic Particle Size Measurement of:
 - Metered Dose Inhalers (MDIs) 104
 - MDIs with a Spacer/VHC 111
 - Dry Powder Inhalers (DPIs) 118
 - Nebulisers 124
 - Soft Mist Inhalers (SMIs) 130
 - Nasal Sprays 136
 - Nasal Aerosols 141
 - Nasal Powders 147

Ancillaries 154

- Breathing Simulators 156
 - Breathing Simulator Model BRS 100i 158
 - Breathing Simulator Model BRS 200i 162
 - Breathing Simulator Model BRS 300i 167
- Flow Controllers 172
 - Breath Actuation Controller BAC 100i 176
 - Critical Flow Controller TPK 100i 180
- Flow Rate Measurement 184
 - Flow Rate Sensor FRS 186
 - Flow Meter DFM 2000 187
- Vacuum Pumps 188
 - Low Capacity Pump LCP7 190
 - High Capacity Pump HCP7 191
 - Super Capacity Pump SCP7 192
- Environmental Control 194
 - EnviroMate™ 196
 - Anti-Static Grounding Kit 200
 - Electrostatic Eliminator 200
 - Digital Static Meter 200
 - NGI Cooler™ 202
- Inhaler Testing Workstation™ ITW 204
 - Spare/Additional Tubing 207
 - Quick-Release Connectors 207
 - Glass Expansion Chambers 208
 - Kiel Nasal Inlet KNI 212
 - Mouthpiece & Nosepiece Adapters 214

Inhalytix+® 218

Improving IVIVCs 226

- Background 226
- DDU and APSD Testing 230
 - Realistic Breathing Profiles 230
 - Mixing Inlet 231
 - Realistic Throat and Nasal Models 232
 - Alberta Idealised Throat (AIT) 232
 - Alberta Idealised Nasal Inlet (AINI) 233
- Improving IVIVCs: Example Test System for Realistic DDU 235
- Improving IVIVCs: Example Test System for Realistic APSD 237
- Dissolution Testing 242
 - Inhaled Dissolution Apparatus™ IDA 243
- Facemask Testing 250
 - Face Models 251
 - Test Systems for Assessing Facemask Performance 252
 - Facemask Testing Apparatus (FMA) for MDIs with a Spacer/VHC 252
 - Facemask Testing Stand (FMS) For Nebulisers 256

- Morphology 260
- Cold Freon® Effect 261
- Spray Force Tester SFT 1000 262

Special Applications 264

- Abbreviated Impactor Measurement (AIM) 265
 - AIM in QC 265
 - AIM in R&D 266
- Fast Screen Andersen (FSA) 267
- Reduced NGI (rNGI) 269
- Fast Screening Impactor (FSI) 270
- Volume and Resistance Compensator VRC 272
- Generic Drug Development 274
 - Fluticasone Propionate/Salmeterol Aerosols & Powders 275
 - Albuterol Inhalation Aerosols 278
- Device Robustness/Inhaler Misuse 280
 - Patient Exhalation Simulator PES 280
 - Drop Test Apparatus DTA 282
 - NGI Tilting Platform 284

Automation 286

- Automated Shake, Fire and Flow Control for MDIs, Nasal Sprays and Aerosols 290
 - Vertus® III & Vertus III+ 292
 - DecaVertus® III 298
- Automated Drug Recovery 302
 - Sample Recovery System™ SRS 100i 302
- Automated Drug Recovery for DDU Testing 306
 - DUSA Shaker DTS 100i 306
- Automated Cascade Impactor Preparation and Recovery 308
 - Impactor Coater™ IC 200i 308
 - Gentle Rocker™ GR 200i 310
 - Impactor Genie™ IG 200i 312
 - Sample Preparation Unit SPU 200i 314
 - Impactor Cleaning System 320

Qualification/Service & Training 324

- Qualification Services 326
 - Impactor Qualification 326
 - Stage and Components Mensuration 326
 - Data Interpretation 327
 - Impactor Performance Restoration 328
 - In-House and On-Site Equipment Servicing and Calibration 330
 - Qualification Tools and Documents 331
 - IQ/OQ Documentation 331
 - Qualification Tools 332
- Product Protection Plans 333
- Support 334
 - Training Services 335
 - Inhaler Testing Academy® 335

Index 336





Orally Inhaled Drug Products

Metered-Dose Inhalers (MDIs)

MDIs use a propellant to deliver a fixed volume of liquid solution or suspension to the patient in the form of an aerosol.

They are small, inexpensive, convenient for the user and suitable for a wide range of drugs. However, the use of MDIs requires good coordination and technique to actuate the device. The actuation force needed means they are not always suitable for elderly or paediatric users. The use of breath-actuated MDIs or add-on devices such as spacers or valved holding chambers (VHCs) can help resolve these problems.



Orally Inhaled & Nasal Drug Products (OINDPs)

The range of OINDPs available is broad, encompassing inhalers (metered-dose, dry powder and soft mist), nebulisers (jet, ultrasonic and vibrating mesh) and nasal sprays, aerosols and powders (aqueous-based, propellant-based and dry powder).

- A Metered-Dose D Soft Mist
- B Dry Powder E Nasal Spray
- C Nebuliser F Nasal Powder

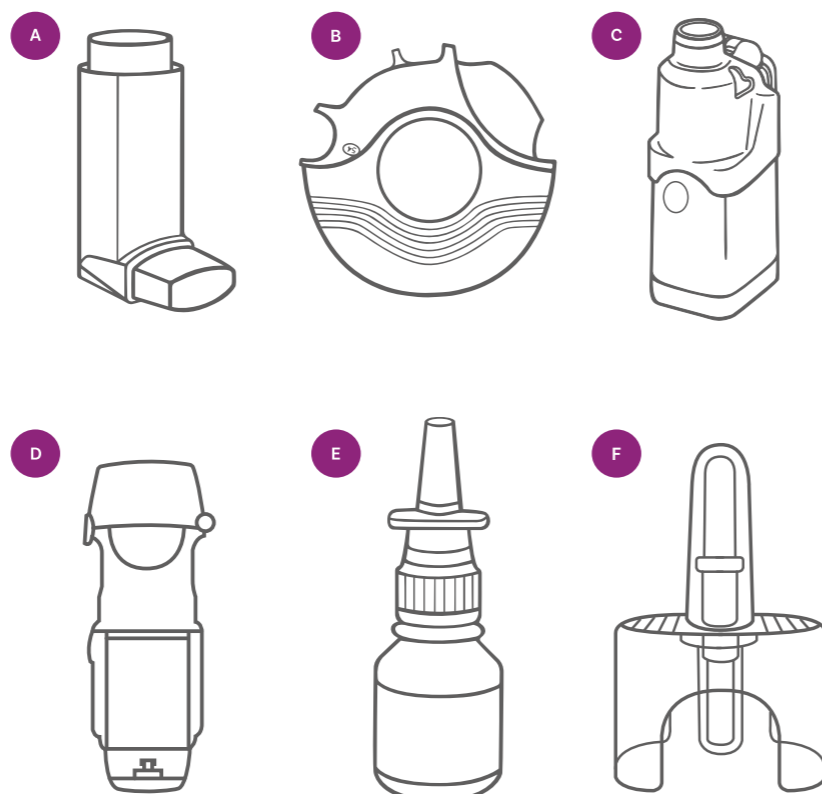

Conventional Pressurised

Comprises a pressurised canister containing the medication and propellant, together with a delivery device - normally a metering valve linked to an actuator. Pressing down on the canister releases the drug in the form of an aerosol cloud - this is then inhaled into the lungs.

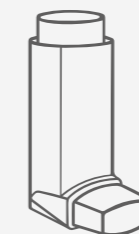

Breath-Actuated

Senses the patient's inhalation through the actuator and synchronises dose delivery with it.



Spacers/VHCs

Add-on devices such as these reduce or eliminate a) the need for coordination between actuation and inhalation and b) the cold Freon® effect (see page 261), enhancing drug delivery.

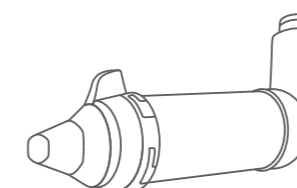

Spacers/VHC: Coordinated v Uncoordinated use

Performance is optimal and directly comparable with a standard MDI if the patient inhales from the spacer/VHC as the device is actuated. This is called '**coordinated use**'.

In contrast, the worst case scenario is if actuation coincides with exhalation, i.e. '**uncoordinated use**'.

Dry Powder Inhalers (DPIs)

As the name suggests, with a DPI the medication comes in the form of a dry powder, rather than a liquid.

Typically, the active pharmaceutical ingredient(s) is mixed with a coarser excipient, such as lactose, to which it attaches. During aerosolisation the active is stripped from the carrier and inhaled whilst the carrier particles impact on the mouth and throat and are ingested.

However, their relatively high cost and reliance on inhalation strength and duration are potential drawbacks.

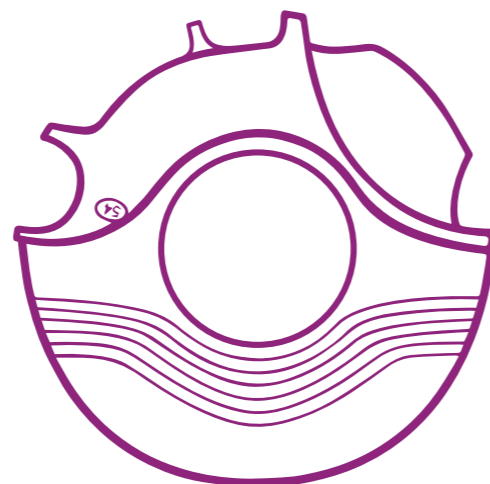

Passive

The majority of DPIs are passive devices, that is to say drug delivery is driven solely by the inspiration of the patient. There is no need to coordinate breathing with the actuation - the patient simply inhales deeply to access the drug.

Pre-Metered



The dose is pre-measured during manufacture (for example, blisters, capsules or similar cavities).

Unit Dose

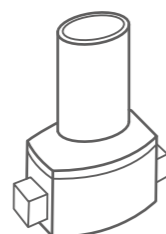

The pre-measured dose in the form of a gelatine capsule or blister is loaded by the patient prior to use.

Device-Metered



The drug is contained in a reservoir within the device which measures each dose on actuation.

DID YOU KNOW?

Some DPIs actively generate the aerosol, reducing dependence on patient inhalation, whilst simultaneously improving the accuracy and reproducibility of the delivered dose.

Such devices are normally termed 'active' DPIs and are particularly useful where the patient's own inspiration capability is compromised. Assistance normally comes in the form of pressurised/compressed air or through vibrations generated by a piezoelectric transducer.

Nebulisers

Nebulisers convert a liquid into aerosol droplets to produce a respirable cloud suitable for inhalation. They are widely used at home and in hospital and require little or no coordination for effective use. Nebulisers are normally loaded with the drug before each treatment and usually operate continuously once loaded.

The main advantage of nebulisers is that their use requires little or no coordination on the part of the patient. However, they tend to be cumbersome and require either compressed air or an electrical supply. Expense, inefficiency and inter-brand variability can also cause issues.

Ultrasonic



Use electricity to vibrate a piezoelectric crystal at high frequency. The resultant vibrations are transmitted to a reservoir containing the liquid drug formulation, creating a series of waves from which liquid droplets separate to form an aerosol.

Jet

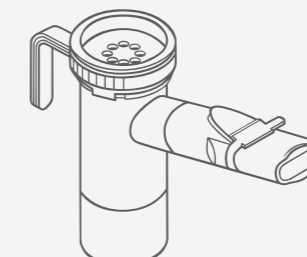

Use a compressed air supply to atomise the liquid drug formulation to produce a fine mist using the Bernoulli principle. Can be subdivided into three types depending on their output during exhalation.

Mesh



Uses the piezoelectric effect to vibrate a mesh at ultrasonic frequency which results in droplets being formed by fluid moving through holes in the mesh (holes either electroformed or laser drilled) to form a cloud prior to inhalation.

Standard

Constant output throughout the respiratory cycle.

Some jet and mesh nebulisers incorporate sensing devices to detect the patient's inspiration in order to provide breath-enhanced, breath-activated or breath-integrated systems, and there are smart versions that use Adaptive Aerosol Delivery technology to analyse the patient's breathing pattern to determine the timing of aerosol delivery during inhalation.

Breath-Enhanced

Continuous aerosolisation but provides higher output during inhalation.

Breath-Actuated

Aerosol produced only during inhalation.

Soft Mist Inhalers (SMIs)

Both MDIs and DPIs suffer from the same two inherent problems: low lung deposition (typically 5-20%) and dose variability (often due to patient difficulties in coordination or inspiration).

SMIs (often known as “Inhalation Metered Sprays” or “Aqueous Droplet Inhalers”) actively aerosolise the liquid, forming a ‘soft mist’ to overcome these problems. These inhalers generally deliver a higher fine particle fraction than MDIs or DPIs. However, as with any multi-dose liquid system, microbial contamination can be a problem.

SMIs do not use a propellant to aerosolise the liquid. Methods of aerosol generation include:

- (a) Forcing liquid through a nozzle
- (b) Electro spraying
- (c) Thermal generation
- (d) Vibration mesh

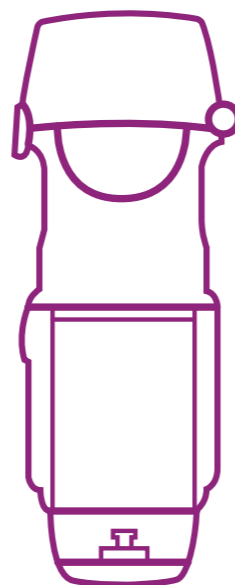

Nasal Drug Products

Like inhalers, nasal products can be liquid-, propellant- or powder-based. They are commonly multi-dose although unit dose devices are popular for delivering vaccines and pain relief.

Nasal Sprays



Mechanical metered-dose spray pumps are designed to deliver an accurate and consistent dose to the user.

Multi-dose spray pumps have dominated the nasal market and are widely available through a number of device manufacturers.

Unit-dose devices that deliver one or two shots (one per nostril), are usually based on the syringe principle.

Nasal Aerosols



Nasal aerosols are propellant-based and directly analogous to pressurised MDIs. An angled nosepiece or nozzle facilitates insertion into the nostril.

Nasal Powders



Available in both multi- and unit-dose formats, powder-based devices offer preservative-free delivery and can produce longer nasal retention times than liquids.

Powder-based nasal sprays are more ideal for peptides, hormones and antigens than liquid formulations and where high dose concentrations are required.

Applications of OINDPs

Pulmonary and nasal delivery offers a number of advantages compared to traditional oral and parenteral (subcutaneous injection) routes:

Directly targets the site of action	Rapid onset of drug action	Drugs effective in relatively low doses
Fewer side effects	Avoids first pass metabolism	Non-invasive administration

Such drugs include treatments for diverse applications such as diabetes, erectile dysfunction, migraine, osteoporosis and for vaccine delivery.

Orally Inhaled Drug Product Applications

Orally inhaled drugs are becoming increasingly popular as a means of delivering local or systemic therapy via the lungs.

Local Treatment

To treat lung diseases such as asthma and chronic obstructive pulmonary disease (COPD), and to deliver locally acting drugs such as antibiotics and antivirals directly to the lungs to curb infection.

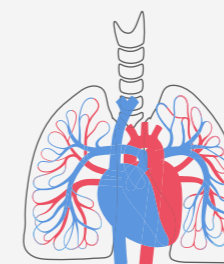

Systemic Treatment

Considerable research and development has been devoted to delivering new drugs into the systemic circulation via the inhaled route - no doubt attracted by the large surface area and easy air/blood interface provided by the respiratory system.



Nasal Drug Product Applications

Traditionally, nasal preparations have been used for the local administration of antihistamines, decongestants and steroids in order to alleviate cold or allergy symptoms and nasal congestion.

More recently attention has focused on two other areas:

Systemic Circulation

There is potential for rapid drug absorption into the systemic circulation via the turbinates. This route is already in use in a number of areas, e.g. migraine and pain relief, osteoporosis, vaccines.



Central Nervous System

The potential of “Nose to Brain” entry to the central nervous system is presented by the olfactory region at the top of the nasal cavity for the treatment of, for example, diseases of aging such as Alzheimer’s disease.

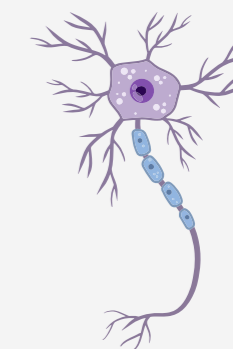

Organisations and their Roles

The ultimate responsibility for the safety, quality and efficacy of medicines and medical devices lies with the various national regulatory bodies designated to safeguard public health.

Regulatory Bodies in the UK, European Union, China, Japan and USA

At present, there are no worldwide standards that are specifically applicable to OINDPs.

In the European Union, the responsibility for the regulation of medicines lies with the European Medicines Agency (EMA) in the form of the Committee for Medicinal Products for Human Use (CHMP).

The EMA was set up in 1995 to harmonise the work of existing national regulatory bodies in Europe.

The main guidance from the EMA relating to OINDPs is contained in two guidelines:

- CPMP (2025): "Guideline on the Pharmaceutical Quality of Inhalation and Nasal Medicinal Products".
- CPMP (2025), "Guideline on the Requirements for Demonstrating Therapeutic Equivalence Between Orally Inhaled Products (OIP) for Asthma and Chronic Obstructive Pulmonary Disease (COPD)".

These guidelines give a comprehensive list of the parameters that are critical to the safety, quality and efficacy of the final product dependent on the specific type of inhaled or nasal preparation concerned.

From 1 January 2024, developers of new medicines can now submit applications via the UK's Medicines and Healthcare products Regulatory Agency (MHRA) new International Recognition Procedure (IRP). The IRP was developed by the MHRA following the UK's departure from the European Union. The EMA and Food and Drug Administration (FDA) are two of a number of Reference Regulators (RR) to the MHRA, the IRP being open to applicants that have already received an authorisation from an RR.

A similar regulatory function is provided by the National Medical Products Administration (NMPA) in China and the Ministry of Health, Labour and Welfare (MHLW) in Japan. The PMDA (Pharmaceuticals and Medical Devices Agency) is the main agency working alongside the MHLW.

In the USA, the regulatory function is performed by the Food and Drug Administration (FDA) through two centres, the Center for Drug Evaluation and Research (CDER) in respect of medicines and the Center for Devices and Radiologic Health (CDRH) in respect of medical devices.

The relevant current thinking from the FDA is reflected in the following regulatory Guidelines for Industry:

- CDER (2018), "Metered Dose Inhaler (MDI) and Dry Powder Inhaler (DPI) Products - Quality Considerations Guidance for Industry" - Draft
- CDER (2001), "Sterility Requirements for Aqueous-Based Drug Products for Oral Inhalation", Small Entity Compliance
- CDER (2002), "Nasal Spray and Inhalation Solution, Suspension and Spray Drug Products", Chemistry, Manufacturing and Controls Documentation
- CDER (2003), "Integration of dose-counting mechanisms into MDI products", Clinical Medical
- CDER (2003), "Bioavailability and bioequivalence studies for nasal sprays for local action", Biopharmaceutics - Draft

Since December 2013, the FDA has issued a series of product specific guidance relating to various active pharmaceutical ingredients (APIs) including Fluticasone Propionate (FP), Salmeterol, Tiotropium, and Albuterol, amongst others, intended to help generic manufacturers navigate the Abbreviated New Drug Application (ANDA) process (see Special Applications, page 260).

Additionally, the FDA has been focusing on further strategies to support the development of generics, notably complex generics like OINDPs. The document "Alternative *In Vitro* Bioequivalence (BE) Pathways Which Can Reliably Ensure *In Vivo* Bioequivalence of Product Performance with a Generic." (Generic Drug User Fee Amendments (GDUFA)) states, "Additional research is ongoing to explore physicochemical API properties and device characteristics to demonstrate structural similarities (Q3) between test and reference Dry Powder Inhaler (DPI), Metered Dose Inhaler (MDI), and nasal products. A series of projects are exploring these Q3 characteristics, using Morphologically Directed Raman Spectroscopy (MDRS) in conjunction with *in vitro* dissolution, more realistic Aerodynamic Particle Size Distribution (APSD) measurement under realistic *in vitro* testing conditions, and particle surface

characterisation. The goal of this initiative is to provide greater understanding of the complex interactions between device, formulation, and patient factors, and eventually be able to predict the therapeutic behaviour based on these *in vitro* characteristics".

In April 2018, the FDA published a new Draft Guidance for Industry for comment (Revision 1) entitled "Metered Dose Inhaler (MDI) and Dry Powder Inhaler (DPI) Products - Quality Considerations".

This guidance which covers both quality and performance issues as well as CMC information is a revision of the previous 1998 Guidance "updated to reflect current standards and requirements to enhance understanding of appropriate development approaches for these products consistent with the quality by design (QbD) paradigm".



ICH Quality Guidelines	
Q1A - Q1F Stability	Q7 - Good Manufacturing Practice
Q2 - Analytical Validation	Q8 - Pharmaceutical Development
Q3A - Q4B Impurities	Q9 - Quality Risk Management
Q4 - Q4B Pharmacopoeias	Q10 - Pharmaceutical Quality System
Q5A - Q5E Quality of Biotechnological Products	Q11 - Development and Manufacture of Drug Substances
Q6A - Q6B Specifications	Q12 - Lifecycle Management
Q13 - Continuous Manufacturing of Drug Substances and Drug Products	Q14 - Analytical Procedure Development

International Regulation and Harmonisation

The International Council for Harmonisation of Technical Requirements for Registration of Pharmaceuticals for Human Use (ICH) is a unique organisation consisting of representatives from the EMA, MHLW and the FDA, and experts from the pharmaceutical industry in the associated regions, in a single forum.

The purpose of the ICH is to promote greater harmonisation in the way in which the individual regulatory bodies regulate new drugs such that the medicine reaches the patient economically and with the minimum delay, whilst maintaining the standards of safety, quality and efficacy necessary to safeguard public health. (Note: A similar organisation, the International Medical Device Regulators Forum (IMDRF) exists for medical devices).

Whilst not OINDP-specific, the ICH has concentrated on the preparation of four quality related guidelines:

- ICH Q8(R2) Pharmaceutical Development
- ICH Q9(R1) Quality Risk Management
- ICH Q10 Pharmaceutical Quality System
- ICH Q11 Development and Manufacture of Drug Substances

All of which have now been implemented by the regulatory authorities concerned (EMA, FDA and MHLW).

Collectively, these provide the guidelines for a new Pharmaceutical Quality System (PQS) described in ICH Q10. Based on International Standards Organisation (ISO) quality concepts, the new system includes Good Manufacturing Practice (GMP) regulations where applicable and complements ICH Q8 and ICH Q9.

One of the key features of the new PQS is the decision to extend the system to include all parts of the product lifecycle, namely:

- Pharmaceutical Development
- Technology Transfer, e.g. from development to manufacturing
- Manufacturing
- Product Discontinuation

This decision to extend the PQS to include Pharmaceutical Development through the concept of Quality by Design (QbD) is described in more detail in ICH Q8(R2) Part II Pharmaceutical Development – Annex.

The ICH Q8(R2) Annex describes the principles and gives examples of many of the essential concepts employed in QbD including Critical Quality Attributes (CQAs), Design Space and Control Strategy and its implementation through Process Analytical Technology (PAT) Tools.

ICH Q9(R1) describes the principles of quality risk management and their application in a pharmaceutical environment.

ICH Q10 provides a model PQS covering the different stages of a product life cycle and thus a link between pharmaceutical development and manufacturing. As a guideline, ICH Q10 is not enforceable – however, it is likely that the regulators will consider it as standard best practice.

The practical implementation of the guidelines with respect to OINDPs is not easy because of (a) the complexities involved in manufacturing inhalation products, (b) the difficulties in applying real-time test methods to them, and (c) the lack of clear *in vitro* – *in vivo* correlations (IVIVCs) for most formulations. This continues to be an area of considerable discussion in pharmaceutical development, quality and regulatory circles.

ICH Q11 provides a Guideline to the “Development and Manufacture of Drug Substances” including the type and extent of information to be submitted in regulatory dossiers.

Mention should also be made of ICH Q12 which works with ICH Q8-Q11 guidelines to provide a framework to facilitate the management of the entire “Pharmaceutical Product Lifecycle”.

ICH Q13, adopted in November 2021, outlines Current Good Manufacturing Practices (CGMP) specific to the Continuous Manufacturing (CM). The guideline will also provides guidance to industry and regulatory agencies regarding regulatory expectations on the development, implementation, and assessment of CM technologies used in the manufacture of drug substances and drug products.

The ICH Q14 guideline, adopted in May 2022, was developed alongside a revision of the ICH Q2 guideline on Validation of Analytical Procedures. The updated guideline, now published as ICH Q2(R2), came into effect in 2024. The two guidelines are intended to be applied together to support a lifecycle approach to analytical procedure development and validation.



Drug Safety, Quality and Efficacy – The Pharmacopoeias

The main role of the Pharmacopoeias is to define the standards with which medicines shall comply and the methods by which compliance will be adjudged.

As with the regulatory groups, the leading Pharmacopoeias tend to be those of the European Union, USA, China and Japan.

a) European Pharmacopoeia (Ph. Eur.)

In the Ph.Eur., the initial information relating to the control of OINDPs is contained in the monograph associated with the dosage form concerned, e.g. “Preparations for Inhalation (0671)” with cross references to appropriate methods of testing, e.g. “2.9.18. Preparations for Inhalation: Aerodynamic Assessment of fine particles” and 2.9.54. “Uniformity of Delivered Dose of Inhalation and Nasal Preparations”.

The Ph.Eur. is also responsible for “Pharmeuropa”, a bi-monthly publication available free online, which contains “Draft Monographs and General Texts for Comment” and “International Harmonisation”. This publication is a good indicator of new and/or amended monographs, e.g. - “Calibration and Mensuration Issues for the Standard and Modified ACI” Vol.12.4, p.584-588 (2000) - “2.9.44 Preparations for Nebulisation: Characterisation” Vol. 18.2, p.280-283 (2006).

b) United States Pharmacopoeia (USP)

Historically, the USP has adopted a similar approach to the Ph.Eur. but placed more emphasis on the Physical Tests and Determinations, e.g. “Aerosols, Nasal Sprays, Metered-Dose Inhalers and Dry Powder Inhalers <601>” than the type of dosage form, e.g. “Pharmaceutical Dosage Forms <1151>”.

However, in USP 38, the Pharmacopoeia introduced a series of new chapters, <1> through to <5>, which provide general information about the Critical Quality Attributes (CQAs) applicable to various dosage forms based on their route of administration.

These chapters detail the test procedures relevant to each dosage form, divided between those relating to product quality and those to product performance.

Product quality tests assess physical, chemical and microbial attributes. Product performance tests assess drug release from the dosage form concerned.

In the case of “Inhalation and Nasal Drug Products”, the quality tests are described in Chapter <5> whereas the performance tests are described in Chapter <601>.

Both Ph.Eur. 2.9.44 and USP <1601> include chapters on tests designed to characterise nebulisers.

In addition, USP Chapter <1602> covers testing of the “Spacers and Valved Holding Chambers used with Inhalation Aerosols – Characterization Tests” and Chapter <1603> covers “Cascade Impactor Practices”. In December 2023, Chapter <1604> “Data Interpretation of Aerodynamic Particle Size Distribution Measurements for Orally Inhaled Products” was made official, covering APSD data handling and analysis.

The USP also includes a series of product-specific monographs intended to provide clarification of the testing of certain generics by methods not previously specified in the general chapters.

Like Ph.Eur., USP produce a bi-monthly publication which contains discussion documents relating to new and/or amended chapters and monographs. “Pharmacopoeial Forum” features items relating to “In-Process Revision”, “Harmonisation” and “Stimuli to the Revision Process”.

c) Chinese Pharmacopoeia (ChP)

The ChP has four chapters contained within its Volume IV applicable to OINDPs, <0111>, <0112>, <0113> and <0951>, plus five drug specific monographs.

Chapter <0111> relates to general requirements applicable to MDIs, DPIs and nebulisers (incl. DDU) whilst <0951> describes those methods relating to APSD measurement for OINDPs.

d) Japanese Pharmacopoeia (JP)

The JP has two chapters related to OIPs, “Chapter <6.14> on Delivered Dose Uniformity” and “Chapter <6.15> on Particle Size Distribution”. In addition to these, a General Chapter “G6.4 General Information” is available and applicable to OINDPs.

Device Safety, Quality and Efficacy – International Standards Organisation (ISO)

Most OINDPs are unique dosage forms in so far as that they comprise two components:

- (a) The drug formulation(s)
- (b) The medical device delivering that formulation to the patient

The responsibility of defining the standards relating to the medical device resides with the ISO.

The relevant standards are “ISO 20072 Aerosol drug delivery device design verification – Requirements and test methods” for inhalers and “ISO 27427 Anaesthetic and respiratory equipment – Nebulising systems and components” for nebulisers.



Expert Groups

In addition to the above, there are a number of industry and quasi-industry expert groups whose role it is to assist the regulatory bodies in establishing best practice in their thinking and guidance.



European Pharmaceutical Aerosol Group (EPAG)

A group of 16 member companies active in the OINDP market within Europe, formed to establish scientifically-based best practice, provide consensus comment to industry and government agencies on safety and quality issues, and recommend harmonised standards and methodology. Copley is an invited member of the cascade impactor and nasal sub-teams.



International Pharmaceutical Consortium on Regulation and Science (IPAC-RS)

A group of 16 members and 14 associate members committed to advancing consensus-based, scientifically driven standards and regulations for OINDPs worldwide. Copley is an associate member.



Product Quality Research Institute (PQRI)

PQRI is a collaborative, research organisation involving the FDA's CDER, industry and academia.

It was formed to provide consensus advice on the scientific information to be submitted in a regulatory filing to CDER and has been involved in a number of OINDP-related products.

Organisational Chart: Guidelines and Regulations

	Metered-Dose Inhaler (MDI)*	Dry Powder Inhaler (DPI)	Soft Mist Inhaler	Nasal Products	Nebuliser
Regulatory					
EMA Guidelines	Guideline on the Pharmaceutical Quality of Inhalation and Nasal Products (EMA/CHMP/QWP/49313/2005 Rev.1)				
	Guideline on the Requirements for Clinical Documentation for Orally Inhaled Products (OIP) including the Requirements for Demonstration of Therapeutic Equivalence between Two Inhaled Products for use in the Treatment of Asthma and Chronic Obstructive Pulmonary Disease (COPD) EMA/CHMP/300218/2017 Rev.2				
FDA Draft Guidance for Industry	Metered-Dose Inhaler (MDI) & Dry Powder Inhaler (DPI) Products (2018) - Quality Considerations				
				Nasal Aerosols and Nasal Sprays for Local Action (2003)	
FDA Guidance for Industry				Nasal Spray, Inhalation Solution, Suspension & Spray Drug Products (2002)	
Drug Efficacy					
European Pharmacopoeia 2026 (12.3)	Preparations for Inhalations (Dosage Forms 0671) Aerodynamic Assessment of Fine Particles (Chapter 2.9.18) Uniformity of Delivered Dose of Inhalation and Nasal Preparations (Chapter 2.9.54)			Nasal Preparations (Dosage Forms 0676) Uniformity of Delivered Dose of Inhalation and Nasal Preparations (Chapter 2.9.54)	Preparations for Nebulisation (Chapter 2.9.44)
US Pharmacopoeia 2026 (USP 49)	Inhalation & Nasal Drug Products - General Information & Product Quality Tests <5> Aerosols, Nasal Sprays, Metered-Dose Inhalers and Dry Powder Inhalers <601> Uniformity of Dosage Units <905> Cascade Impactor Practices <1603> Data Interpretation of Aerodynamic Particle Size Distribution Measurements for Orally Inhaled Products <1604> Pharmaceutical Dosage Forms (Aerosols - Inhalations) <1151>				Products for Nebulization <1601>
	Spacers & VHCs <1602>				
Chinese Pharmacopoeia 2025	Inhalation Products - Metered-Dose, Dry Powder Inhalers and Nebulisers - Delivered Dose Uniformity <0111> Aerodynamic Particle Size Distribution (APSD) <0951>				
Japanese Pharmacopoeia (JP18)	Delivered Dose Uniformity <6.14> Particle Size Distribution <6.15> General Information <6.4>				
Device Efficacy					
International Standards Organisation	Aerosol Drug Delivery Devices - Requirements and test methods (ISO 20072: 2013)			Nebulizing Systems (ISO 27427: 2023)	
Expert Groups					
European Pharmaceutical Aerosol Group (EPAG)	EPAG European based industry expert group involved in orally inhaled and nasal drug products				
International Pharmaceutical Consortium on Regulation & Science (IPAC-RS)	IPAC-RS US based industry expert group involved in orally inhaled and nasal drug products				
Product Quality Research Institute (PQRI)	PQRI A collaborative research organisation involving FDA's CDER, industry and academia				

Delivered Dose Uniformity (DDU)

One of the four **Critical Quality Attributes (CQAs)** that determine the safety, quality and efficacy of orally inhaled and nasal drug products (OINDPs) as discussed in the previous chapter, delivered dose is the total amount of drug emitted from the drug device that is available to the user, when the device is actuated correctly.

The delivered dose is measured by firing the drug device into a sampling apparatus containing a filter. The dose is captured, dissolved in solvent and an aliquot is then analysed, normally using high pressure liquid chromatography (HPLC).

Each OINDP dose typically contains a mixture of one or more active pharmaceutical ingredients (API) together with excipients designed to help with dose delivery to the patient. It is critical to assess that the API dosage delivered is consistent, or 'uniform' with each administration to ensure the correct drug amount is delivered to the patient each time.

The uniformity of the delivered dose, or DDU, of an OINDP must be ensured within and between devices. A number of tests have been defined by the various regulatory authorities, which are designed to demonstrate:

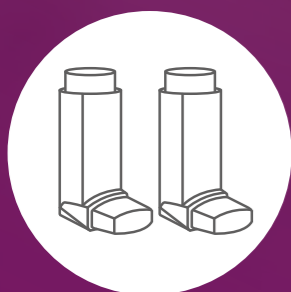

Inter-batch dose consistency

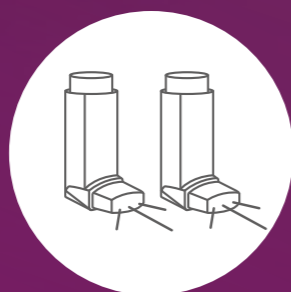

Intra-dose consistency for multi-dose inhalers throughout device life



The number of deliveries are greater than or equal to the label claim



In the case of dry powder inhalers (DPIs), different flow rates specific to the device resistance are considered

DDU Over the Entire Contents

Both the European Pharmacopoeia (Ph. Eur.) and United States Pharmacopoeia (USP) state that DDU tests should be carried out on all orally inhaled products (OIPs) and that in the case of multiple-dose devices* tests should be carried out throughout the life of the inhaler i.e. dose uniformity over the entire contents.

In the case of Ph.Eur., for example, this involves the collection of 10 doses throughout the life of each individual inhaler: three doses at the beginning, four in the middle and three at the end (see below).

** In the case of Ph. Eur., for DPIs this only applies to reservoir type devices.*

Example: Ph. Eur. DDU Over the Entire Contents Requirements			
Inhaler Life	Beginning	Middle	End
No. required doses	3 shots	4 shots	3 shots
Dose no.	2, 3, 4	49, 50, 51, 52	98, 99, 100
100 labelled doses	90 shots to waste		
Dose no.	2, 3, 4	99, 100, 101, 102	198, 199, 200
200 labelled doses	190 shots to waste		

Similar testing requirements exist for other pharmacopoeias and regulatory guidance (see page 12). To obtain the required doses for analysis, the remaining contents of the inhaled device must be wasted (and done so appropriately, i.e. reproducibly and safely).

Collection Devices for DDU Testing

Depending on the type of inhaler device under test, different apparatus set-ups are required. The key collection devices are highlighted below. For further information about device-specific testing, please proceed to the relevant sections within this chapter.

For MDIs, DPIs, BAIs and SMIs Dose Collection

Dose Uniformity Sampling Apparatus (DUSA)

Two types of DUSA are available for DDU testing - a DUSA for MDIs and a DUSA for DPIs; each are additionally suitable for testing other device types.

Typically, the device is connected to the DUSA via a mouthpiece or nosepiece adapter (see page 214). The drug-laden plume released upon actuation of the

device is drawn into the DUSA using a vacuum pump (see page 188) connected to the outlet via a suitable length of tubing.

During testing, air is drawn through the sampling apparatus to broadly simulate inhalation. Test conditions are therefore dependent on device type.

Basic system set-up for DDU testing (Ph. Eur.)

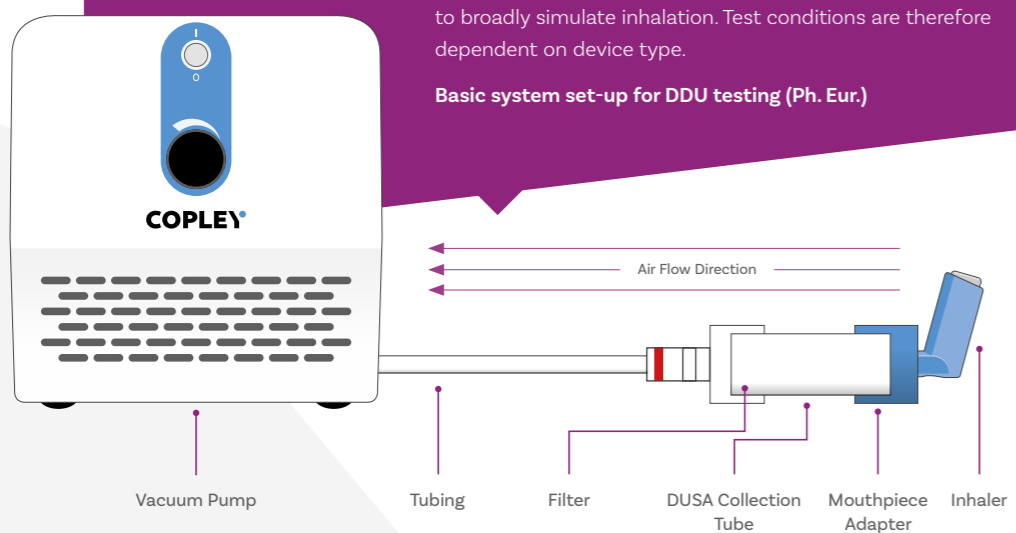

Basic system set-up for DDU testing (USP)

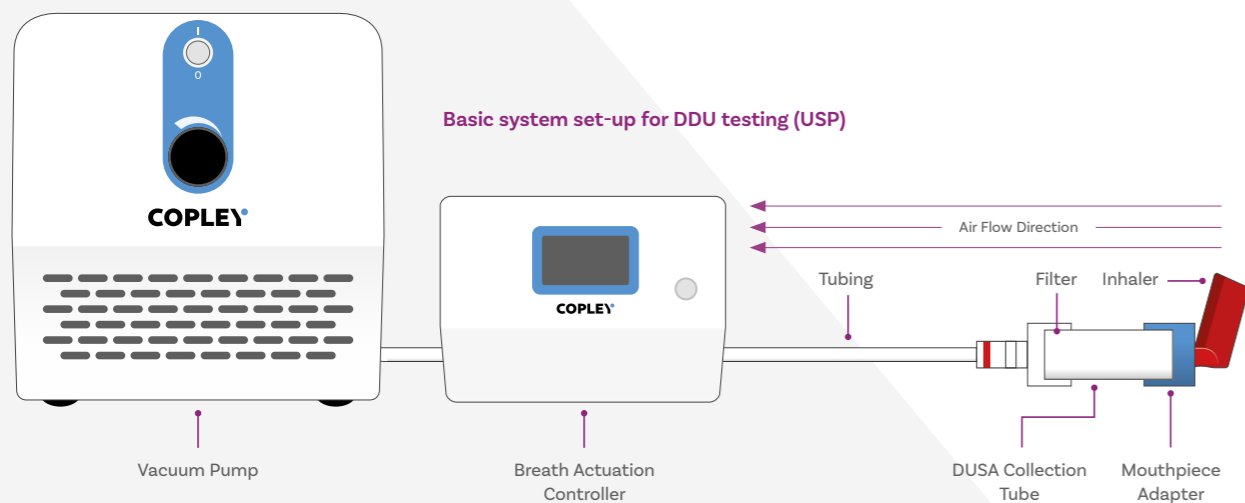

DUSA for MDIs

Suitable for DDU testing of: MDIs BAIs SMIs

Also suitable for DDU testing of Nasal Sprays & Nasal Aerosols (see page 26)

The DUSA for MDIs consists of a sample collection tube, a filter to capture the delivered dose and a connector to connect the DUSA with the wider test set-up. It has been designed to enhance productivity and ensure ease-of-use.

Schematic of a DUSA for MDIs

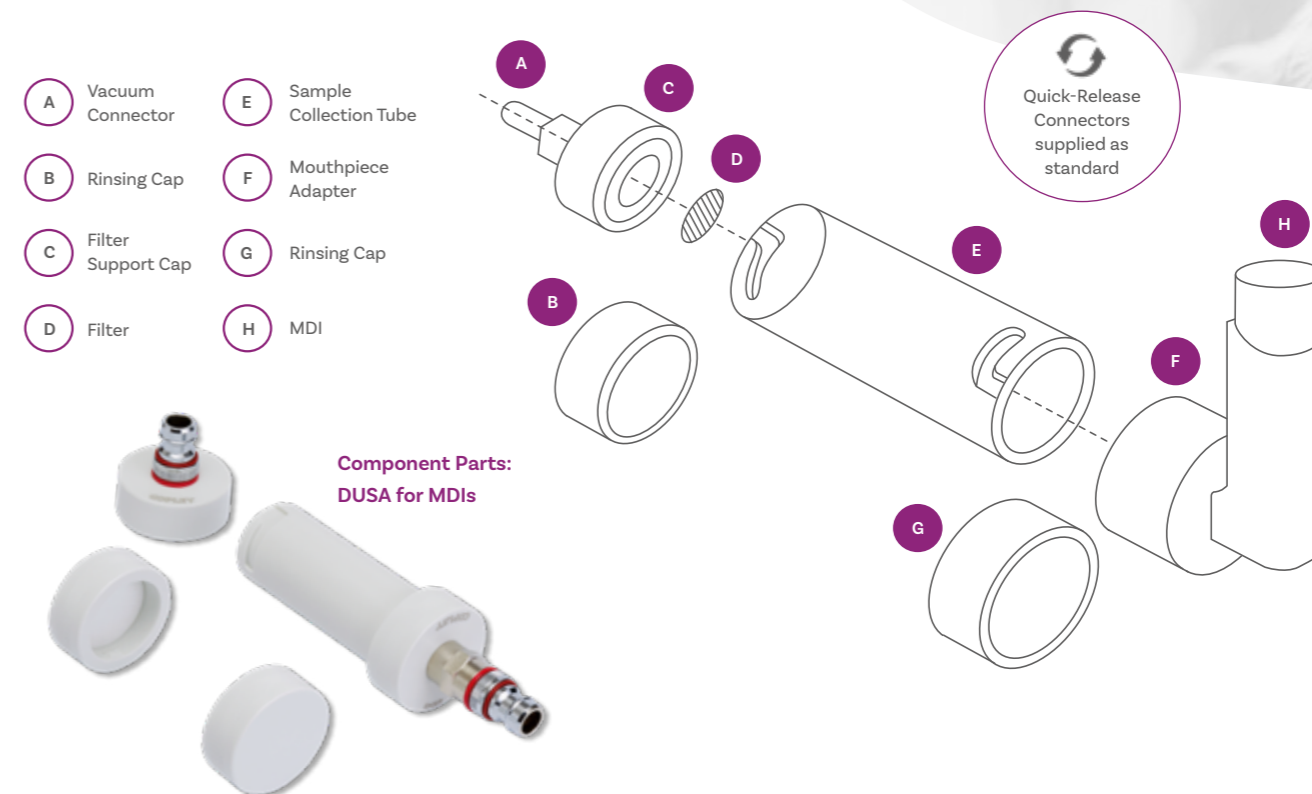

Automating Dose Collection

Compatible with most MDIs, the Vertus® III automated shake and fire range offers extensive parameter control and monitoring for precise and reproducible testing.

Easing the burden associated with routine manual dose uniformity testing, the Vertus III range eliminates firing errors, controls air flow speed and automates leak testing.

The Vertus III+ model offers the additional benefit of automated shot weight collection.

For further information, please see page 292.



Dose Uniformity Sampling Apparatus (DUSA) for MDIs

Cat. No.	Description
8201	Dosage Unit Sampling Apparatus for MDIs (Silicone Rubber Seals)
8201A	Dosage Unit Sampling Apparatus for MDIs (LDPE Seals)

Accessories

8211	Stand for 10 MDI Collection Tubes
------	-----------------------------------

Note: Aluminium or 316 Stainless Steel DUSAs are available, if required

Spare Parts

Cat. No.	Description
8202	Set of 3 Silicone Rubber Seals for MDI
8202A	Set of 3 LDPE Seals for MDI
8203	Collection Tube for MDI
8204	Filter Support Cap for MDI
8205	Rinsing Cap (Silicone Rubber Seal) for MDI
8205A	Rinsing Cap (LDPE Seal) for MDI
8206	Flow Meter Cap (Silicone Rubber Seal) for MDI
8206A	Flow Meter Cap (LDPE Seal) for MDI
8207	Stainless Steel Filter Support Disc for MDI
8210	Pack of 500 Glass Fibre Filters for MDI

DUSA for DPIs

Suitable for DDU testing of: DPIs

Also suitable for DDU testing of Nasal Powders (see page 26)

The DUSA for DPIs is a larger version of the DUSA for MDIs and is designed specifically to sample at flow rates up to 100 L/min. It is also used to characterise the flow resistance of DPIs. The pressure port (P1) in its wall is used to connect a critical flow controller to measure the pressure drop across the device.

Schematic of a DUSA for DPIs

- Vacuum Connector
- Rinsing Cap
- Filter Support Cap
- Filter
- Sample Collection Tube
- Pressure Port (P1)
- Mouthpiece Adapter
- DPI
- Rinsing Cap



Component Parts: DUSA for DPIs

During testing, air is drawn through the sampling apparatus to broadly simulate inhalation. A critical flow controller is required to control air flow supply to the inhaler and ensure critical (sonic) flow conditions during testing.

Basic system set-up for DDU testing of DPIs (according to Ph. Eur. and USP)

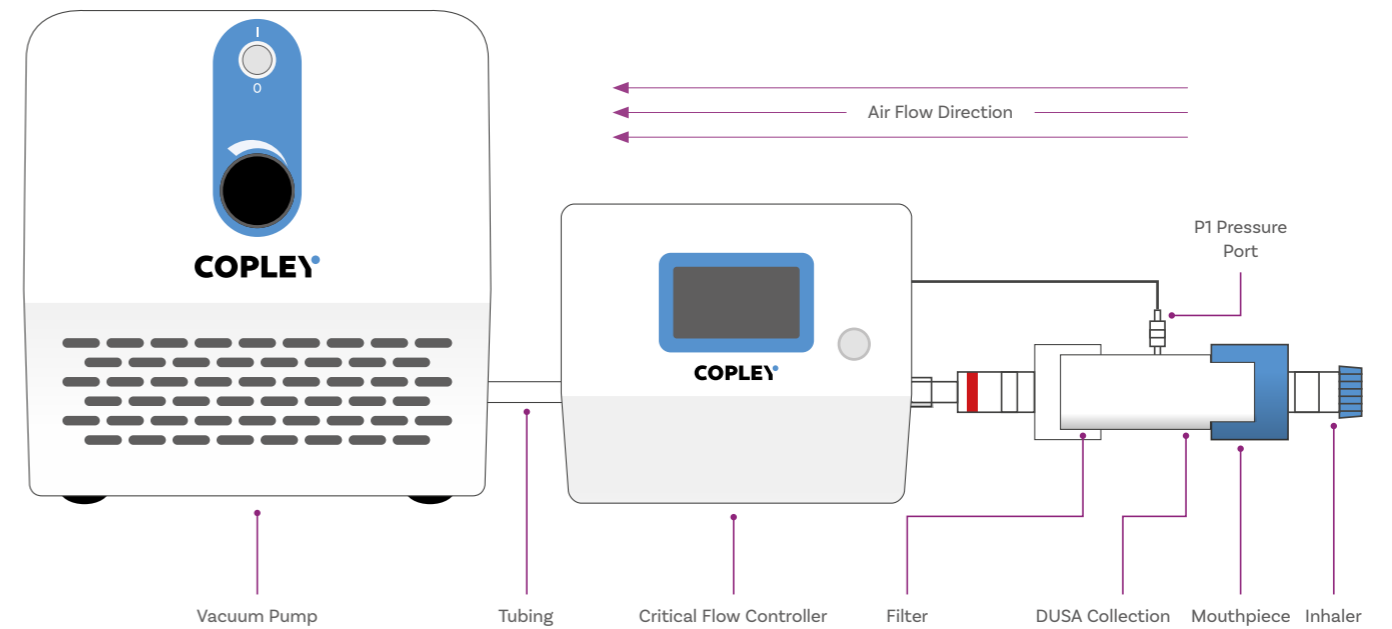

Dose Uniformity Sampling Apparatus (DUSA) for DPIs

Cat. No.	Description
8601	Dosage Unit Sampling Apparatus for DPIs (Silicone Rubber Seals)
8601A	Dosage Unit Sampling Apparatus for DPIs (LDPE Seals)

Accessories

8604	Stand for 10 DPI Collection Tubes
------	-----------------------------------

Note: Aluminium or 316 Stainless Steel DUSAs are available, if required

Spare Parts

Cat. No.	Description
8602	Set of 3 Silicone Rubber Seals for DPI
8602A	Set of 3 LDPE Seals for DPI
8603	Pack of 100 Glass Fibre Filters for DPI
8606	Filter Support Cap for DPI
8607	Rinsing Cap (Silicone Rubber Seal) for DPI
8607A	Rinsing Cap (LDPE Seal) for DPI
8608	Collection Tube with P1 Port for DPI
8608A	Collection Tube without P1 Port for DPI
8609	Flow Meter Cap (Silicone Rubber Seal) for DPI
8609A	Flow Meter Cap (LDPE Seal) for DPI
8610	Stainless Steel Filter Support Disc for DPI

Waste Shot Collection

Firing inhaled drug product shots to waste requires an evacuation system, which captures the aerosol emitted from repeated actuations of the device. The system must be capable of trapping large quantities of the drug for safe disposal. We offer both manual and automated fire-to-waste systems.

Waste Shot Collector: WSC2



The Waste Shot Collector WSC2 is a compact vacuum filtration system suitable for use with a range of devices. It can be used in either standalone mode or integrated into the Inhaler Testing Workstation™ ITW (see page 204), via a switching valve, whereby the vacuum pump used for the DUSA powers both sampling and waste collection units.

Waste doses are captured in a disposable cartridge which collects and traps the contents in an integral HEPA filter, retaining 99.97% of particles over 0.3 microns in diameter.

The WSC2 is also suitable for nasal drug product waste dose collection. See page 28 for further information.

The external dimensions of the inlet of the WSC2 are identical to those of the DUSA. This means that:

- the same mouthpiece adapter (and therefore inhaler) can be used with both pieces of equipment
- the two pieces of equipment are interchangeable within a test set-up so all shots are collected or discharged to waste under identical test conditions

Waste Shot Collector WSC2

Cat. No.	Description
5001	Waste Shot Collector WSC2 (including 1 Cartridge)
5002	Spare Filter Cartridge for Waste Shot Collector
5239	FRS Flow Meter Adapter
5238	DFM Flow Meter Adapter
5007	Waste Shot Tally Counter

Automating Waste Dose Collection

Automating firing-to-waste is highly advantageous from the perspective of conserving analyst time, eliminating the risk of repetitive strain injury, and maximising the repeatability of test data; firing-to-waste under well-defined, closely controlled conditions eliminates a potential source of variability in testing.

Priming & Waste Module: Vertus® III/Vertus III+ For MDIs

The Priming & Waste Module integrates firing-to-waste into automated dose uniformity test collection methods, enabling compendial entire contents testing with minimal manual input. Vertus III and Vertus III+ can switch automatically between priming and test levels, firing-to-waste or to dose collection as required, without operator intervention, enabling highly efficient testing procedures, most notably to meet through-life test requirements for DDU. Additionally, the Priming & Waste Module can be used as a standalone interface for waste shot collection. For further information, see page 292.



DecaVertus® III For MDIs

DecaVertus III is a high-throughput automated shake and fire to waste system for reproducible and controlled waste shot collection. Accommodating up to 10 inhalers per run, DecaVertus III ensures firing-to-waste occurs under closely controlled conditions every time. Since DecaVertus III is fully compatible with Vertus III/Vertus III+, methods can be easily transferred between systems, with DecaVertus III often used to alleviate the burden of through-life testing.

For further information, see page 298.



British Pharmacopoeia (BP) Content Uniformity Apparatus for MDIs



In addition to the Ph.Eur. and USP specified DUSA, the BP has its own unique apparatus for determining the “Content of Active Ingredient delivered by actuation of the valve”, likely retained for historical reasons. This comprises a stainless steel base plate having three legs and a central hole to accept the actuator stem in a small vessel (to which solvent is added) suitable for shaking.

BP Content Uniformity Apparatus for MDIs

Cat. No.	Description
8212	BP Content Uniformity Apparatus for MDIs

For MDIs with Spacers/VHCs and for Nebulisers

Advanced Filter Holder

The Advanced Filter Holder is designed for DDU testing for both MDIs with spacers VHCs and for nebulisers.

The Advanced Filter Holder is designed for use together with a breathing simulator, which is used to apply the specific breathing profile required for representative device operating conditions (see page 156). A filter is

contained within the holder, to capture the delivered dose. The device under test is interfaced with the Advanced Filter Holder using a suitable mouthpiece adapter. For assessing the effects of a facemask for each device type, see page 250.

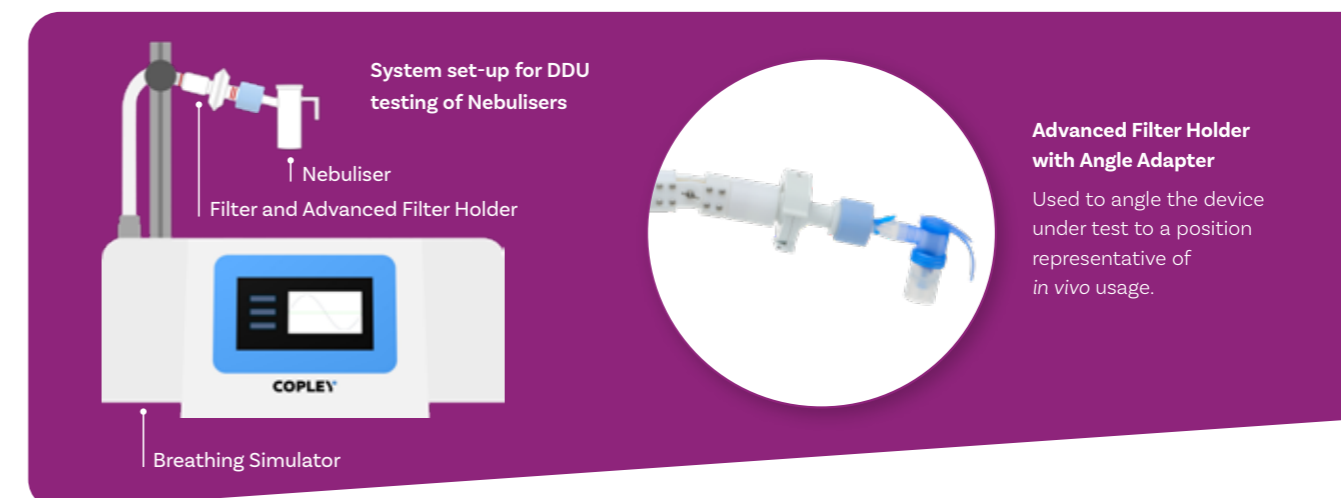

Advanced Filter Holder with Angle Adapter
Used to angle the device under test to a position representative of in vivo usage.

Advanced Filter Holder for MDIs with Spacers/VHCs and for Nebulisers

Cat. No.	Description
9133	Advanced Filter Holder and Adapter for Breath Simulator BRS 100i
9177	Advanced Filter Holder and Adapter for Breath Simulator BRS 200i/300i
9103	Pack of 100 Filters for Advanced Filter Holder
9104	Angle Adapter for Breath Simulator BRS 100i

For Nasal Sprays, Nasal Aerosols and Nasal Powders

We offer multiple *in vitro* fire-to-sample and fire-to-waste options for new and generic nasal drug product testing, plus options for automation to not only ease the burden associated with routine analysis but reduce variability and improve data integrity.

Dose Collection

Dose Uniformity Sampling Apparatus (DUSA)

As recommended in Ph. Eur. 0676 and USP <601>, we offer the Inhaler Testing Workstation™ ITW with a specially designed DUSA holder that can be oriented in a vertical or near-vertical position for more representative manual nasal spray DDU testing. We also offer an angled nasal device holder that enables the nasal spray device to be positioned at a defined and reproducible angle, eliminating manual orientation and improving consistency during DDU testing. See page 206.

Product orientation for fire-to-waste can also match dose collection to help ensure data capture is consistent and truly reflects performance with our innovative vertical Waste Shot Collector WSC2 attachment (see page 28).

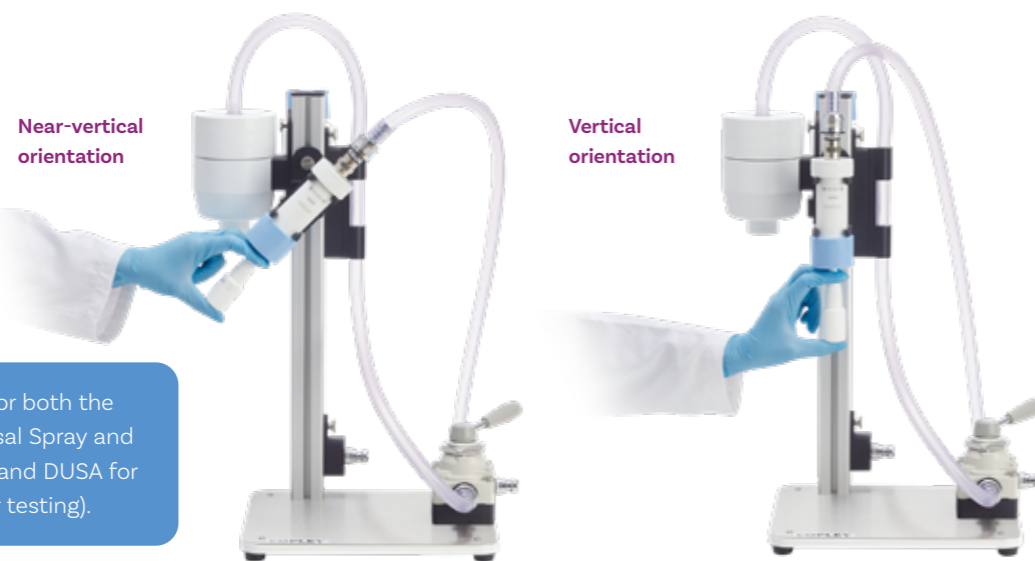

Holders are available for both the DUSA for MDIs (for Nasal Spray and Nasal Aerosol testing) and DUSA for DPIs (for Nasal Powder testing).

Automating Dose Collection For Nasal Sprays and Nasal Aerosols

Simplifying the measurement of delivered dose uniformity testing for nasal drug products in accordance with the European Pharmacopoeia (Ph. Eur.) Chapter 0676 and United States Pharmacopoeia (USP) Chapter <601>, the DUSA Interface Plate enables a simple, leak-free connection between a standard DUSA and the nasal drug product to ensure complete dose capture in a vertical orientation.

Designed for use with the Vertus® III/III+ automated shake and fire system, routine test set-ups for nasal drug products are now easily automated using our complete integrated solution. Vertus III+ offers the additional benefit of automated shot weight collection.

For further information see page 292.



Kiel Nasal Inlet (KNI)

Developed in collaboration with Kiel University, the KNI is a purpose-designed collection device for delivered dose testing of nasal drug products.

The KNI enables vertical and near-vertical actuation while minimising dripping and splashback often associated with nasal product dose collection. Its inlet design creates a controlled seal with the device to prevent leakage, while still allowing airflow through the emitted plume as it passes to a downstream collection filter, supporting representative and reproducible delivered dose assessment.

Flexible Test Configuration

The KNI can be used:

- **Without applied airflow** for straightforward dose consistency testing.
- **With applied airflow** enabling a more clinically relevant assessment and ensuring closer alignment with established compendial tests for orally inhaled products.

This flexibility allows laboratories to perform delivered dose measurements with or without airflow using a consistent equipment configuration.



KNI for DDU dose collection with angled nasal device holder

The KNI is also suitable for use as an inlet to impactor systems for aerodynamic particle size assessment. For further information see page 212.

Nasal Spray Dose Collector NSDC For Nasal Sprays

Loss of nasal spray sample due to dripping and leakage is common, due to the need to fire nasal sprays upwards to simulate actual product use. The NSDC apparatus represents a significant advancement in the

field of nasal spray testing. Designed with precision and functionality in mind, the NSDC (patent pending) offers several key features aimed at enhancing nasal sprays testing accuracy and reliability.



With an opening large enough to prevent splashback, but small enough to greatly reduce the risk of drips and leakage, the NSDC not only ensures accurate collection of the full dose, but also enables dose collection to occur in a vertical orientation to better replicate

in vivo usage. Ensuring accurate collection of the full dose in the vertical orientation, the NSDC can be utilised as a complementary or alternative solution to dose collection with a DUSA.

How does the NSDC work?

The unique design enables vertical actuation of the nasal spray, while minimising any loss of sample caused by dripping out of the collection device. The internal geometry of the NSDC has been engineered to gently direct the nasal spray plume into a well where the sample can be collected for subsequent analysis.

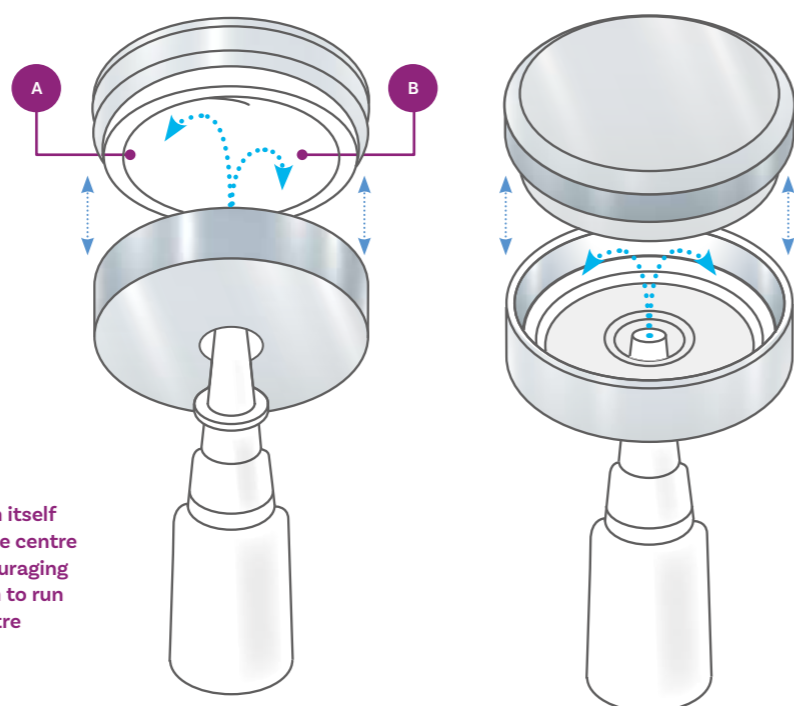

A
The 'shark fin' design deflects spray away from the centre point of the nozzle in an aerodynamic fashion to minimise the risk of any rebound

B
All points on the fin itself slope away from the centre point thereby encouraging any drips that form to run away from the centre

Automating Dose Collection For Nasal Sprays

The NSDC can be used as a standalone device for manual nasal spray dose collection, but automation minimises variability while simultaneously improving productivity and reducing the health and safety risks associated with repeat manual actuation, such as the risk of repetitive strain injury.

The NSDC directly interfaces with Vertus® III/ Vertus III+ shake and fire systems to fully automate actuation and test flow control, meeting the need for highly consistent actuation, as required by USP <601>.

Additionally, the NSDC can be switched easily for the Nasal Spray Waste Collector NSWC (see page 29) for controlled and representative "fire-to-waste" for entire contents testing of multi-dose devices. Vertus III+ offers the additional benefit of automated shot weight collection.

For further information about automation with the Vertus III range, see page 292.



Nasal Spray Dose Collector

Cat. No.	Description
9735	Nasal Spray Dose Collector (NSDC)
9737	Nasal Spray Holder for use with NSDC

Waste Shot Collection

For nasal devices containing multiple doses, delivered dose testing may need to be conducted throughout the life of the device, i.e. dose uniformity over the entire contents. Regulatory guidance also recommends that waste collection occurs under similar conditions to dose collection. We offer a range of waste shot collection devices designed specifically for the waste shot collection of nasal drug products in accordance with the regulatory guidance.

Waste Shot Collector WSC2

The WSC2 (see page 24) can be mounted vertically at 90° for vertical (or near-vertical) nasal product waste shot collection as recommended in Ph. Eur. 0676 and USP <601>. Suitable for nasal sprays, nasal aerosols and nasal powders.



Nasal Spray Waste Collector NSWC For Nasal Sprays

The NSWC is designed to collect high volumes of waste doses with no splashback onto the nozzle, for safe and convenient disposal of the waste drug.



Automating Waste Dose Collection For Nasal Sprays

The NSWC may be used for manual waste shot collection, but automation ensures that waste shot collection occurs under closely controlled and repeatable conditions. Interfacing directly with the Vertus® III/Vertus III+, the NSWC streamlines shot disposal in a time-efficient way, while reducing the health and safety risks associated with repeat manual actuation, such as the risk of repetitive strain injury.

Additionally, the NSWC can be switched easily for the Nasal Spray Dose Collector NSDC (see page 27) or DUSA Interface Plate for controlled and representative dose collection. Vertus III+ offers the additional benefit of automated shot weight collection.

For further information about automation with the Vertus III range, see page 292.



Vertus® III+ with Nasal Spray Waste Collector NSWC

Nasal Spray Waste Collector

Cat. No.	Description
9736	Nasal Spray Waste Collector (NSWC)

USP Monographs

The USP has product-specific monographs for a number of APIs including Albuterol (Salbutamol), and Fluticasone Propionate (FP)/Salmeterol combinations, which are used globally to treat asthma and COPD. Due to their widespread use and application, these active ingredients are routine targets for generic development.

These monographs cover both DDU testing and Aerodynamic Particle Size Distribution (APSD) measurement since these metrics are required for all OIPs due to their defining influence on the success and consistency of drug delivery.

We offer a range of test equipment that closely replicates the original apparatus used in the development of these reference labelled drugs (RLD), enabling bioequivalence testing in accordance with these monographs.

For more information about the various apparatus used, see page 274.

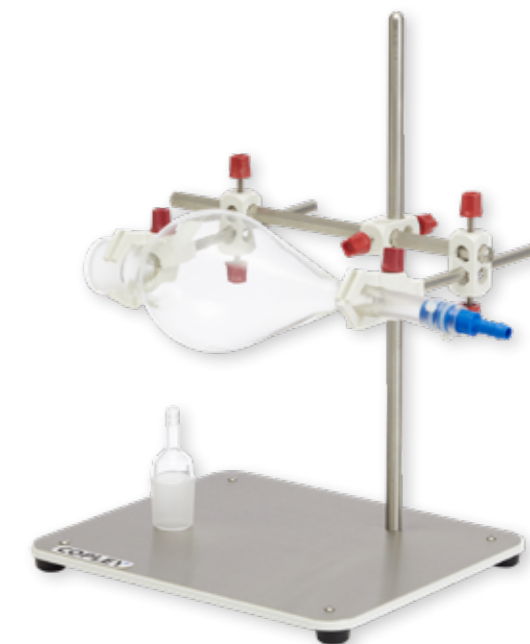

Sample Collection Apparatus for FP/Salmeterol Aerosols

Choose your Delivered Dose Collection Device

	DUSA for MDIs	DUSA for DPIs	BP Content Uniformity Apparatus for MDIs	Advanced Filter Holder	Kiel Nasal Inlet (KNI)	Nasal Spray Dose Collector (NSDC)	USP Monographs
MDI	Y	N	Y	N	N	N	Y
MDI with Spacer/VHC	N	N	N	Y	N	N	N
DPI	N	Y	N	N	N	N	Y
Nebuliser	N	N	N	Y	N	N	N
SMI	Y	N	N	N	N	N	N
Nasal Spray	Y	N	N	N	Y	Y	N
Nasal Aerosol	Y	N	N	N	Y	N	N
Nasal Powder	N	Y	N	N	Y	N	N



Delivered Dose Uniformity

Metered Dose Inhalers (MDIs)

MDI aerosol characteristics are relatively insensitive to changes in air flow rate because the aerosolisation and dispersion mechanisms are dependent on the force generated by the propellant, rather than the patient's inspiratory effort. Therefore, for MDIs, the test flow rate is fixed at an arbitrary value of 28.3 L/min.

A vacuum pump is used to draw air through the assembled test set-up at this flow rate.

However, these test conditions are not applied for DDU testing when the MDI is intended for use with

an add-on device such as a spacer or valved holding chamber (VHC).

Further information about the DDU testing of MDIs with a spacer or VHC can be found on page 40.

Regulations & Guidelines

The sampling procedure and acceptance criteria for the DDU of MDIs varies according to the regulatory authority concerned.

Organisation	Chapter(s)/Guidance	Key DDU Tests
EMA	Guideline on the Pharmaceutical Quality of Inhalation and Nasal Products 2006	Pharmaceutical Development: <ul style="list-style-type: none"> • DDU Through Container Life • DDU Over Patient Flow Rate Range Product Manufacture: <ul style="list-style-type: none"> • Mean Delivered Dose • Delivered Dose Uniformity • Content Uniformity / Uniformity of Dosage Units
Ph. Eur.	Chapter 0671	Uniformity of Delivered Dose Number of Deliveries per Inhaler
FDA	MDI & DPI Products - Quality Considerations Draft Guidance 2018	Delivered Dose Uniformity
USP	Chapter <601>	Delivered Dose Uniformity of Product Dose Uniformity Over the Entire Unit Life
Ch.P.	Chapter 0111	Delivered Dose Uniformity
JP	Chapter 6.14	Delivered Dose Uniformity

DDU Over the Entire Contents

Organisation	1st Test Tier No. of Inhalers	1st Test Tier Criteria	2nd Test Tier No. of Inhalers	2nd Test Tier Criteria
Ph.Eur	10 Inhalers/ 1 prime 3 beginning of life 4 middle of life 3 end of life	9/10 doses to be 75-125% of Mean All doses to be 65-135% of Mean Mean to be 85-115% of LC*	20 Inhalers/ 1 dose	27/30 doses to be 75-125% of Mean Value All doses to be 65-135% of Mean Value Mean Value to be 85-115% of LC*
USP	10 Inhalers/ 1 prime 1 beginning of life 1 end of life	N/A	N/A	N/A
EMA	As per Ph.Eur.	As per Ph.Eur.	As per Ph.Eur.	As per Ph.Eur.
FDA	10 Inhalers/ 1 beginning of life 1 end of life	18/20 doses to be 80-120% 20/20 to be 75-125% of TDD** Mean to be 85-115% of TDD**	20 Inhalers/ 1 beginning of life 1 end of life	54/60 doses to be 80-120% of TDD 60/60 to be 75-125% of TDD** Mean to be 85-115% of TDD**
Ch.P.	1 Inhaler/10 doses (MDIs) and Multidose DPIs) 10 inhalers/1 dose of each	9/10 doses to be 75-125% and all to be 65-135% of Average Delivered Dose Mean to be 80-120% of LC*	2 inhalers/20 doses 20 inhalers/1 dose of each	27/30 doses to be 75-125% and all to be 65-135% of Average Delivered Dose Mean to be 80-120% of LC*
JP	1 Inhaler/10 doses	9/10 to be 75-125% of Mean Value All to be 65-135% of Mean Value Mean to be 85-115% of LC*	2 inhalers/20 doses	27/30 doses to be 75-125% of Mean Value All to be 65-135% of Mean Value Mean to be 85-115% of LC*

* - Label Claim ** - Target Delivered Dose

DDU of MDIs Manual Test System Set-Up

The minimum set-up for DDU testing as specified by the Ph. Eur. comprises a sample collection tube, fitted at one end with a suitable mouthpiece adapter to accept the inhaler under test and connected at the other end to a vacuum pump capable of continuously drawing 28.3 L/min through the inhaler.

In addition to the specifications laid down by the Ph. Eur., the FDA recommends and the USP specifies that the volume of air to be sampled should not exceed 2

litres; this being the volume of air adjudged to be typical of the average patient.

This additional criterion can be met by positioning an electronically operated timer controlled two-way solenoid valve, such as that incorporated in the Breath Actuation Controller BAC 100i.

DDU for MDIs: Test Specifications

Flow Rate (Q)	28.3 L/min
Air Volume (Ph. Eur./EMA)	Not defined
Air Volume (USP/FDA)	2 litres

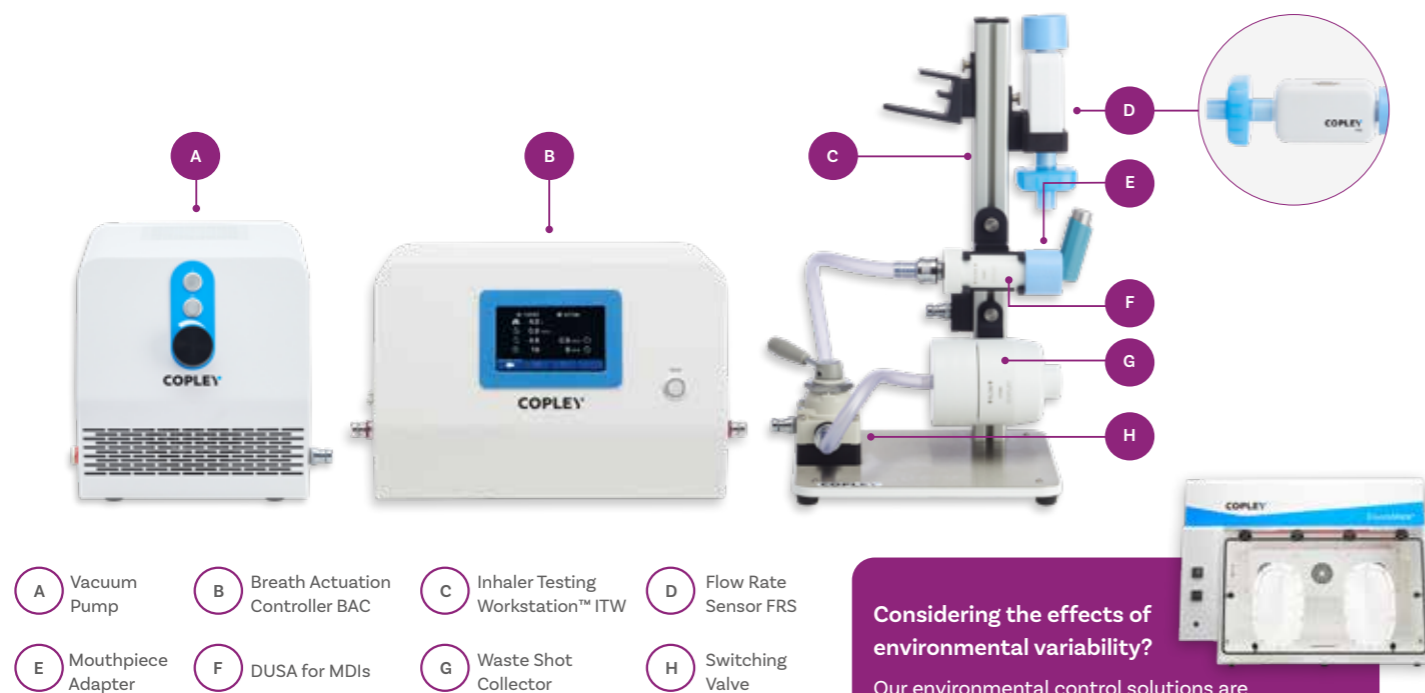

Considering the effects of environmental variability?
Our environmental control solutions are designed to help improve the accuracy, sensitivity and reproducibility of test data.
Learn more on page 196.

Related Accessories



DUSA Collection Tube Stand
Designed for the convenient transfer of multiple DUSA for MDIs around the laboratory. See page 22.



Temperature and Relative Humidity Sensor
Ideal for measuring environmental test conditions. See page 179.



MDI Actuation Sensor/Footswitch
Suitable for most commercially available MDI canisters, the MDI Actuation Sensor connects directly to the Breath Actuation Controller BAC 100i to ensure precise synchronisation of MDI actuation. Alternatively, a Footswitch can be attached to trigger actuation. See page 179.

DDU of MDIs: Manual Test System Component Parts



Dose Uniformity Sampling Apparatus DUSA for MDIs

See page 20.

In addition to the DUSA for MDIs, the following is needed to complete a fully-operational test set-up for the delivered dose testing of MDIs:

Vacuum Pump

Designed for optimal operation at the low flow rates required for MDI testing, the Low Capacity Pump LCP7 represents the latest in high performance, low maintenance, vacuum pump technology. Our Vacuum Pump range is specifically designed for use in the testing of OINDPs in accordance with pharmacopoeial requirements.

See page 188 for further information about our Vacuum Pump range.



Breath Actuation Controller BAC

Ensuring that the volume of air sampled does not exceed pharmacopoeial specifications, the Breath Actuation Controller BAC 100i contains an electronically operated, timer-controlled two-way solenoid valve and is positioned between the DUSA and vacuum pump.

See page 176 for further information about our Flow Controller range.

TOP TIP The BAC 100i can also be used for the testing of Breath-Actuated (or Breath-Operated) MDIs. In this case, the BAC 100i is used to initiate the flow, simultaneously triggering the breath-actuated inhaler.

Flow Rate Sensor FRS

Used for establishing accurate and consistent inlet flow rate during testing, the Flow Rate Sensor FRS measures flow rates to the accuracy specified by the pharmacopoeias.

See page 184 for further information about flow rate measurement.



DDU of MDIs: Manual Test System Component Parts

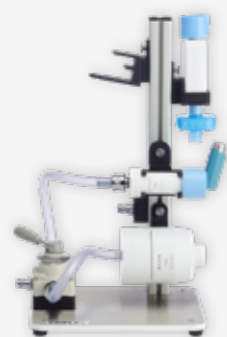

Inhaler Testing Workstation™ ITW

Designed to keep the sampling apparatus organised during testing and improve workflow efficiency, the Inhaler Testing Workstation ITW holds the DUSA collection tube, vacuum connector, flow meter and Waste Shot Collector WSC2.

See page 204 for further information.

Waste Shot Collector and Switching Valve

A compact vacuum filtration system, the Waste Shot Collector WSC2 captures aerosols emitted from repeated actuations of the inhaler, trapping large quantities of the drug for safe disposal. The Switching Valve is used to re-direct air flow between the collection device and WSC2 for quick and easy dose wasting.

See page 24 for further information about the WSC2. Alternatively, automate labour-intensive MDI waste shot collection with the Vertus® III/Vertus III+ and DecaVertus® III (see page 290).



Mouthpiece Adapter

Moulded from high quality silicone rubber, our Mouthpiece Adapters guarantee an airtight seal between the inhaler and the test apparatus. For a list of available Mouthpiece Adapters see page 214.

Custom Mouthpiece Adapters are available upon request.

Qualification

Good Manufacturing Practices (GMP) regulations require that

- The test methods used to monitor pharmaceuticals must meet proper standards of accuracy and reliability
- Companies should establish procedures to ensure the fitness for use of instruments that generate data supporting product testing



Copley provides a range of qualification documentation, services and tools to meet these requirements.

See page 324 for further information.

DDU of MDIs Automated Test System Set-Up

The Vertus® III automated shake, fire and shot waste range is made up of integrated turn-key solutions for precise, controlled and reproducible MDI testing.

Compatible with most MDIs, the Vertus range offers analysts complete control over:

- The speed, angle and duration of shaking, ahead of actuation
- Firing force and the speed of application and release of that force
- The time delay between the end of shaking and device actuation



Improve inhaler testing accuracy and reproducibility



Increase productivity and reduce hassle



Replicate test methods across different sites with ease



Reduce handling errors and costly out-of-specification results

Vertus III & Vertus III+

Offering high productivity, walkaway MDI testing, the Vertus III and Vertus III+ can collect doses at the start, middle and end of product life (including shots to waste as required). The Vertus III+ also offers optional shot weight collection.

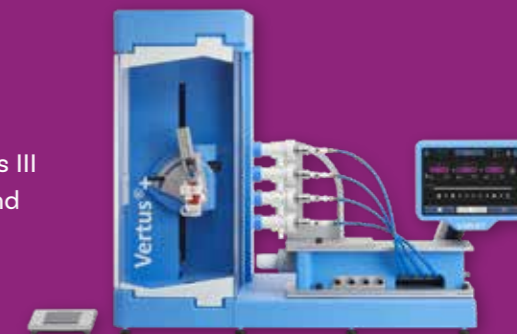

DecaVertus® III

Accepting up to 10 inhalers per run, DecaVertus III is a high-throughput shake and fire-to-waste system, ideal for alleviating the burden of tedious through-life testing.

Replaces the need for:

Vacuum Pump



Flow Controller



Inhaler Testing Workstation™ ITW



Waste Shot Collector with Switching Valve



See page 290 for further information about the Vertus III and DecaVertus III range.

Related Applications

We also offer a range of equipment for additional MDI testing application support:



For better *in vitro-in vivo* correlation (IVIVC) testing
See page 226

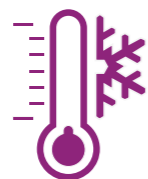

For cold Freon® effect testing
See page 261



For USP product-specific monograph testing
See page 274

Automation Tools

- Improve efficiency
- Reduce variability
- Eliminate handling errors
- Increase testing capacity



DUSA Shaker™ DTS 100i

The DTS 100i automates the internal rinsing of the DUSA collection tubes for full, fast and repeatable drug dissolution and drug recovery.

See page 306 for further information.

Training, Servicing & Support

We offer a comprehensive range of services from bespoke product design to installation, expert training and technical support, optimising all aspects of pharmaceutical testing from start to finish.



Training
See page 335



Servicing
See page 330



Support
See page 334



Design
See page 335



Delivered Dose Uniformity

MDIs with a Spacer/VHC

Add-on devices such as spacers, VHCs and reverse VHCs reduce or eliminate the need for coordination between actuation and inhalation and are widely used together with MDIs to overcome coordination issues.

When a patient uses an MDI without an add-on device, the drug particles contained within the delivered dose are inhaled almost instantaneously as the formulation is aerosolised. In contrast, when an add-on device such as a spacer or VHC is used, the patient inhales the drug from a reservoir of aerosolised particles.

The additional dead volume provided by this reservoir allows aerosol expansion, but also an opportunity for particle impaction, settling and/or electrostatic deposition within the chamber itself, all of which can change the delivered dose.

As the use of add-on devices has grown, the regulatory authorities have become increasingly aware of the need to test with add-on devices as distinct from MDIs alone.

The amount of drug received by the patient using an add-on device with an MDI will be directly influenced by the inhalation profile of the user concerned. For that reason, tests call for the application of specific breathing profiles to reflect the physiology of the intended user, see Table 1.

Add-on Device Schematic

- A Mouthpiece
- B Spacer/VHC
- C Inhaler

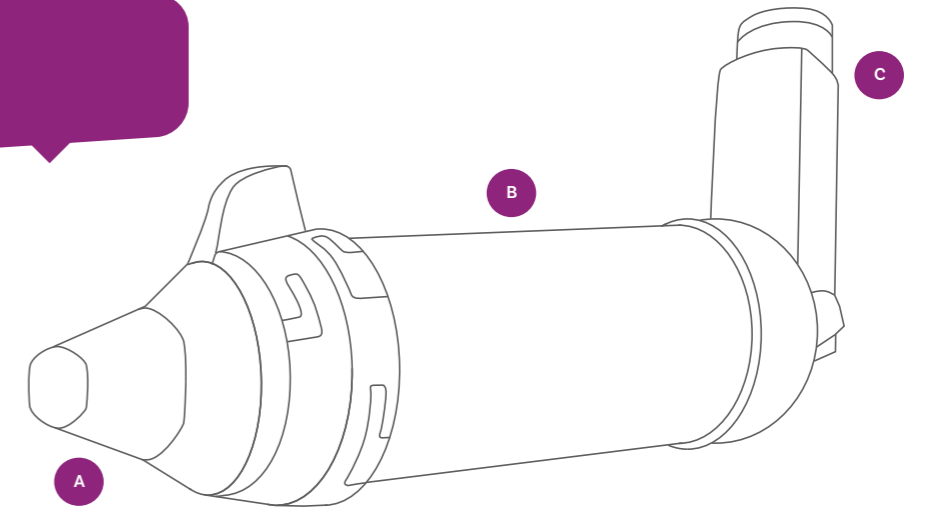

Regulation & Guidelines

The sampling procedure for the DDU testing of MDIs with a spacer/VHC varies according to the regulatory authority concerned.

Organisation	Chapter(s)/Guidance	Key DDU Tests
FDA	MDI & DPI Products - Quality Considerations Draft Guidance 2018	Effect of Flow Rate and Inhalation Delay on MDIs with Spacers
USP	Chapter <1602>	Mass of drug delivered - fully coordinated and fully uncoordinated

Table 1: Representative Tidal Breathing Patterns					
Parameter	Paediatric			Adult	
	Neonate	Infant	Child	Normal 1	Normal 2
Tidal Volume (mL)	25	50	155	770	500
Frequency (cycles/min)	40	30	25	12	13
I/E Ratio	1:3	1:3	1:2	1:2	1:2
Minute Volume (mL)	1000	1500	3875	9240	6500

For DDU over the entire contents testing of MDIs with a spacer/VHC and a facemask, see page 250.

DDU of MDIs with a Spacer/VHC Test System Set-Up

The standard sampling apparatus for MDIs with an add-on device consists of a breathing simulator to generate the specified breath profile, a filter holder containing the filter to capture the delivered dose and a suitable mouthpiece adapter to connect the filter holder to the mouthpiece of the spacer/VHC concerned.

In the case of VHCs, tests are also carried out to compare the dose received when use is coordinated or uncoordinated with device actuation, to assess the impact of valve operation.

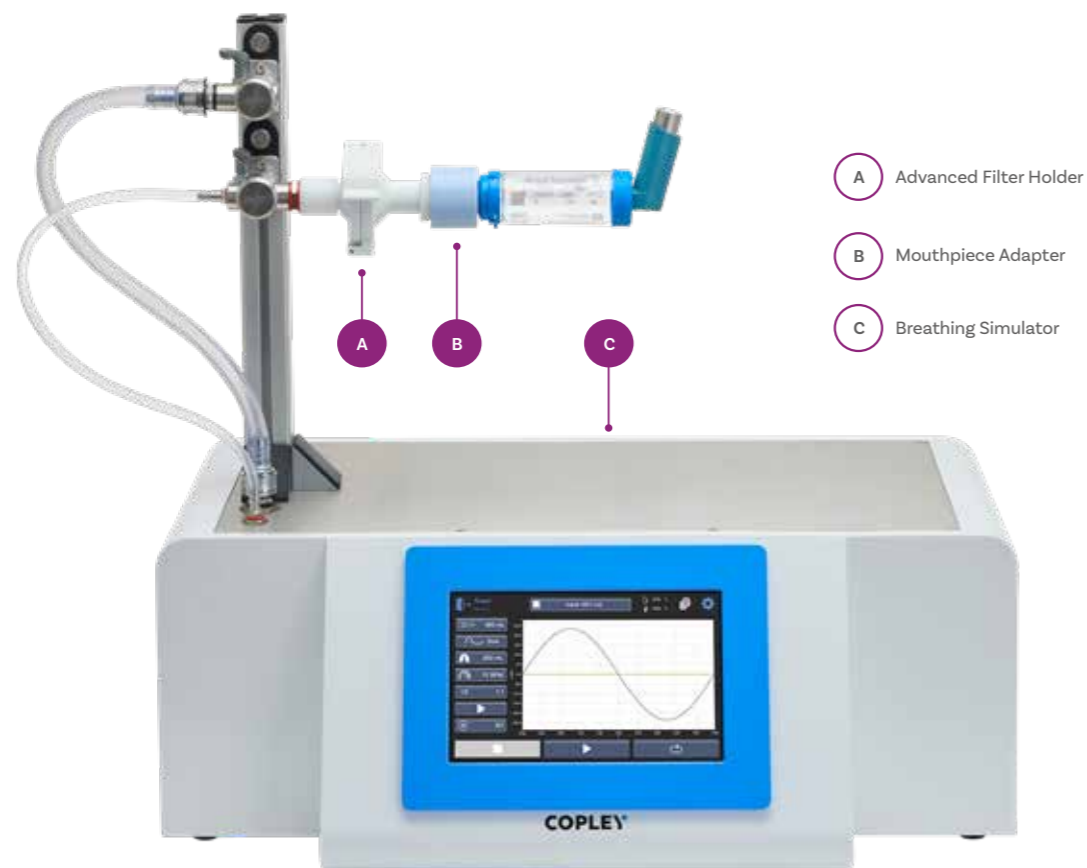

Related Accessories



MDI Actuation Sensor/Footswitch

Suitable for most commercially available MDI canisters, the MDI Actuation Sensor connects directly to the Breath Actuation Controller BAC 100i to ensure precise synchronisation of MDI actuation. Alternatively, a Footswitch can be attached to trigger actuation. See page 179.

Considering the effects of environmental variability?

Our environmental control solutions are designed to help improve the accuracy, sensitivity and reproducibility of test data.

Learn more on page 196.



TOP TIP

The constant 28.3 L/min air flow rate applied during the testing of MDIs is replaced by a specific patient relevant tidal breath profile more representative of the conditions applied by the patient when using an add-on device.

DDU of MDIs with a Spacer/VHC: Test System Component Parts



Advanced Filter Holder (with Adapter for Breath Simulator Model BRS 100i)

See page 25.

In addition to the Filter Holder, the following is needed to complete a fully-operational test set-up for the delivered dose testing of MDIs with a spacer/VHC.

Breathing Simulator

Providing breathing profiles more representative of *in vivo* behaviour than conventional systems offering a constant flow rate, the Breathing Simulator BRS 200i is ideal for assessing the effects of a spacer or VHC on the DDU of MDIs.

Alternatively, a basic entry-level model, the Breathing Simulator BRS 100i, is also available.

Find out more about our range of Breathing Simulators on page 156.



Mouthpiece Adapter

Moulded from high quality silicone rubber, our Mouthpiece Adapters guarantee an airtight seal between the spacer/VHC and the test apparatus. For a list of available Mouthpiece Adapters see page 214.

Custom Mouthpiece Adapters are available upon request.

Qualification

GMP regulations require that

- The test methods used to monitor pharmaceuticals must meet proper standards of accuracy and reliability
- Companies should establish procedures to ensure the fitness for use of instruments that generate data supporting product testing



Copley provides a range of qualification documentation, services and tools to meet these requirements.

See page 324 for further information.

Related Applications

We also offer a range of equipment for additional MDIs with a spacer/VHC testing application support:



For facemask testing
See page 250

Training, Servicing & Support

We offer a comprehensive range of services from bespoke product design to installation, expert training and technical support, optimising all aspects of pharmaceutical testing from start to finish.



Training
See page 335



Servicing
See page 330



Support
See page 334



Design
See page 335

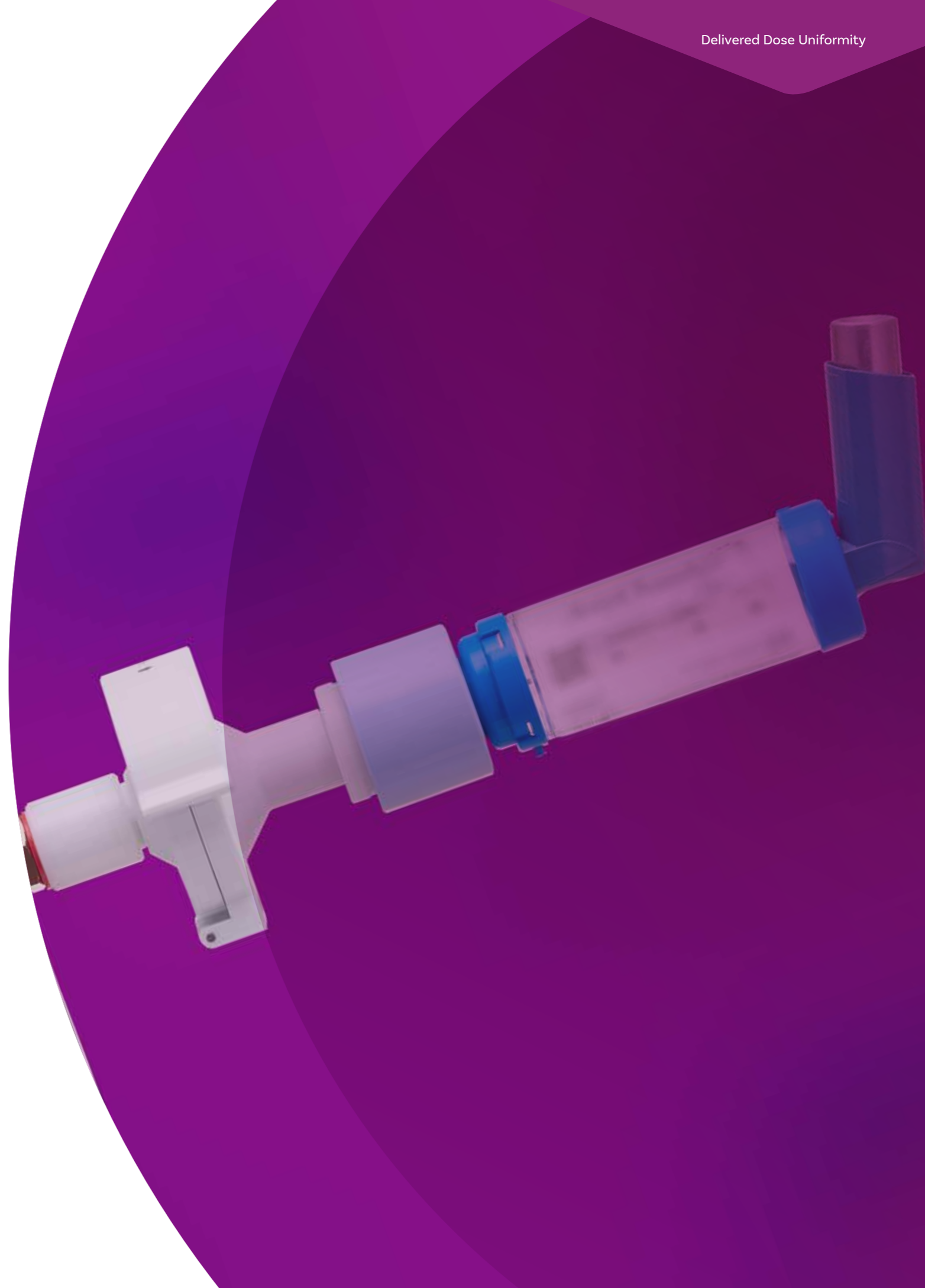



Delivered Dose Uniformity

Dry Powder Inhalers (DPIs)

For DPIs, the test regime is more complex than for MDIs, since aerosolisation depends on the strength and duration of a single inhalation by the user.

During a single, deep inhalation, a typical adult produces a pressure drop over the device of approximately 4 kPa. Depending on the device flow resistance this will yield a flow rate, typical of the mean patient inhalation flow rate, that is then used for all the required testing of that device.

Pressure difference between lungs and atmosphere when inhaling through a DPI

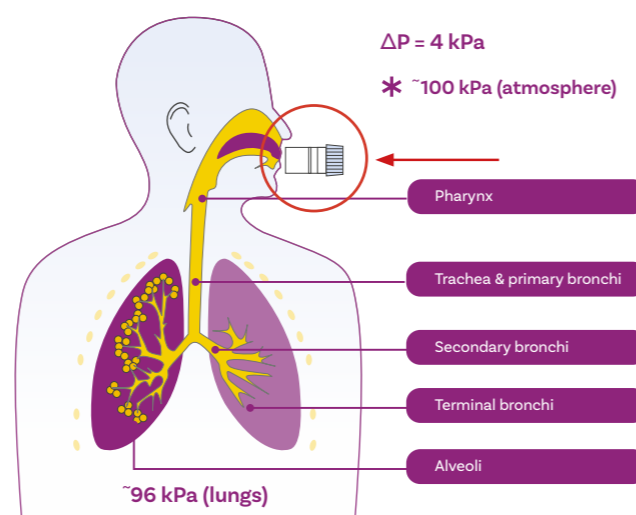

DDU for DPIs: Test Specifications	
Flow Rate (Q)	Device dependent (4 kPa)
Air Volume (Ph. Eur./EMA)	4 litres
Air Volume (USP/FDA)	2 litres

Regulations & Guidelines

The sampling procedure and acceptance criteria for the DDU testing of DPIs varies according to the regulatory authority concerned.

Organisation	Chapter(s)/Guidance	Key DDU Tests
EMA	Guideline on the Pharmaceutical Quality of Inhalation and Nasal Products 2006	Pharmaceutical Development: <ul style="list-style-type: none"> • DDU Through Container Life • DDU Over Patient Flow Rate Range Product Manufacture: <ul style="list-style-type: none"> • Mean Delivered Dose • Delivered Dose Uniformity • Content Uniformity / Uniformity of Dosage Units
Ph. Eur.	Chapter 0671	Uniformity of Delivered Dose Number of Deliveries per Inhaler
FDA	MDI & DPI Products - Quality Considerations Draft Guidance 2018	Delivered Dose Uniformity
USP	Chapter <601>	Delivered Dose Uniformity of Product Dose Uniformity Over the Entire Unit Life
Ch.P.	Chapter 0111	Delivered Dose Uniformity
JP	Chapter 6.14	Delivered Dose Uniformity

DDU Over the Entire Contents

Organisation	1st Test Tier No. of Inhalers	1st Test Tier Criteria	2nd Test Tier No. of Inhalers	2nd Test Tier Criteria
Ph.Eur	10 Inhalers/ 1 prime 3 beginning of life 4 middle of life 3 end of life	9/10 doses to be 75-125% of Mean All doses to be 65-135% of Mean Mean to be 85-115% of LC*	20 Inhalers/1 dose	27/30 doses to be 75-125% of Mean Value All doses to be 65-135% of Mean Value Mean Value to be 85-115% of LC*
USP	10 Inhalers/ 1 prime 1 beginning of life 1 end of life	N/A	N/A	N/A
EMA	As per Ph.Eur.	As per Ph.Eur.	As per Ph.Eur.	As per Ph.Eur.
FDA	10 Inhalers/ 1 beginning of life 1 end of life	18/20 doses to be 80-120% 20/20 to be 75-125% of TDD** Mean to be 85-115% of TDD**	20 Inhalers/ 1 beginning of life 1 end of life	54/60 doses to be 80-120% of TDD 60/60 to be 75-125% of TDD** Mean to be 85-115% of TDD**
Ch.P.	1 Inhaler/10 doses (MDIs) and Multidose DPIs 10 inhalers/1 dose of each	9/10 doses to be 75-125% and all to be 65-135% of Average Delivered Dose Mean to be 80-120% of LC*	2 inhalers/20 doses 20 inhalers/1 dose of each	27/30 doses to be 75-125% and all to be 65-135% of Average Delivered Dose Mean to be 80-120% of LC*
JP	1 Inhaler/10 doses	9/10 to be 75-125% of Mean Value All to be 65-135% of Mean Value Mean to be 85-115% of LC*	2 inhalers/20 doses	27/30 doses to be 75-125% of Mean Value All to be 65-135% of Mean Value Mean to be 85-115% of LC*

* - Label Claim ** - Target Delivered Dose

DDU of DPIs Test System Set-Up

The basic requirements for DPI DDU testing are the same as for MDI testing, namely DUSA, mouthpiece adapter, vacuum pump and flow meter. However, a critical flow controller (e.g. Critical Flow Controller TPK 100i) to measure the pressure drop across the device and control the flow conditions during testing is also required.

This is mandatory because most DPIs are passive breath-actuated devices which rely on the patient's inspiration rather than a propellant for dose aerosolisation and delivery. The testing of DPIs is further

complicated by the fact that different inhalers provide varying degrees of flow resistance, i.e. some require more effort to inhale through than others. Find out more about critical flow control on page 172.

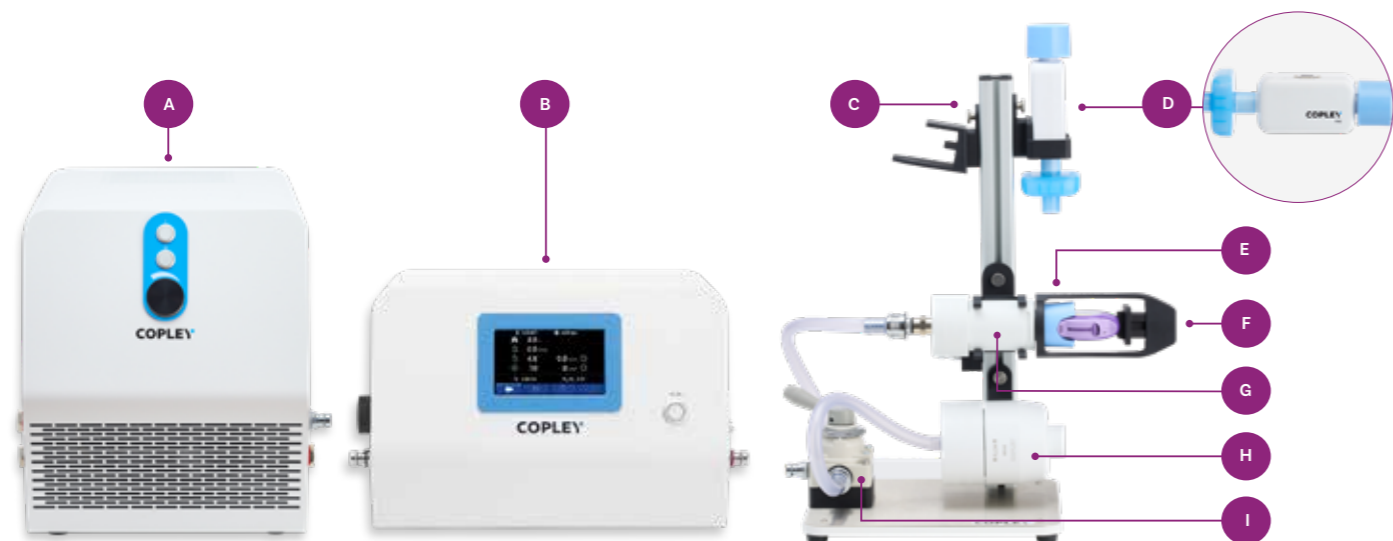

- A** Vacuum Pump
- B** Critical Flow Controller TPK
- C** Inhaler Testing Workstation™ ITW
- D** Flow Rate Sensor FRS
- E** Mouthpiece Adapter
- F** Inhaler Support Accessory
- G** DUSA for DPIs
- H** Waste Shot Collector
- I** Switching Valve

Considering the effects of environmental variability?
Our environmental control solutions are designed to help improve the accuracy, sensitivity and reproducibility of test data.
Learn more on page 196.

Related Accessories



DUSA Collection Tube Stand
Designed for the convenient transfer of multiple DUSA for DPIs around the laboratory. See page 23.



Temperature and Relative Humidity Sensor
Ideal for measuring environmental test conditions. See page 183.



Footswitch
Connecting directly to the Critical Flow Controller TPK 100i, the Footswitch enables precise synchronisation of DPI device actuation with the onset of flow. See page 183.

DDU of DPIs: Test System Component Parts



Dose Uniformity Sampling Apparatus DUSA for DPIs

See page 22.

In addition to the DUSA for DPIs, the following is needed to complete a fully-operational test set-up for the delivered dose testing of DPIs:

Vacuum Pump

Ideal for the higher, sonic flow rate testing requirements of DPIs, the High Capacity Pump HCP7 and Super Capacity Pump SCP7 represent the latest in high performance, low maintenance, vacuum pump technology. Our Vacuum Pump range is specifically designed for use in the testing of OINDPs in accordance with pharmacopoeial requirements.

See page 188 for further information about our Vacuum Pump range.



Critical Flow Controller TPK

Simplify DPI test system set-up in accordance with pharmacopoeial recommendations with the Critical Flow Controller series. Positioned between the DUSA and vacuum pump, the Critical Flow Controller TPK 100i ensures critical (sonic) flow conditions during testing. It measures and records all parameters required for testing and controlling flow conditions.

See page 172 for further information about our Flow Controller Range.

Flow Rate Sensor FRS

Used for establishing accurate and consistent inlet flow rate during testing, the Flow Rate Sensor FRS measures flow rates to the accuracy specified by the pharmacopoeias.

See page 184 for further information about flow rate measurement.



DDU of DPIs: Test System Component Parts

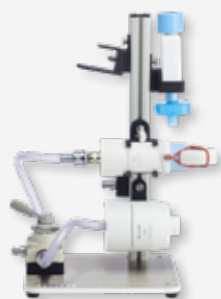

Inhaler Testing Workstation™ ITW

Designed to keep the sampling apparatus organised during testing and improve workflow efficiency, the Inhaler Testing Workstation ITW holds the DUSA collection tube, vacuum connector, flow meter and Waste Shot Collector WSC2

See page 204 for further information.

Waste Shot Collector and Switching Valve

A compact vacuum filtration system, the Waste Shot Collector WSC2 captures aerosols emitted from repeated actuations of the inhaler, trapping large quantities of the drug for safe disposal. The Switching Valve is used to re-direct air flow between the collection device and WSC2 for quick and easy dose wasting. Please note: only required for multi-dose devices.

See page 24 for further information about the WSC2.



Mouthpiece Adapter

Moulded from high quality silicone rubber, our Mouthpiece Adapters guarantee an airtight seal between the inhaler under test and the test apparatus. For a list of available Mouthpiece Adapters see page 214.

Custom Mouthpiece Adapters are available upon request.



Inhaler Support Accessory

Secures the inhaler to the Mouthpiece Adapter, ensuring a stable, airtight interface with a DUSA. See page 215.

DDU Over the Entire Contents

In the case of DPI reservoir type devices, tests should be carried out throughout the life of the inhaler, i.e. dose uniformity over the entire contents. For further information, see page 19.

Qualification

GMP regulations require that

- The test methods used to monitor pharmaceuticals must meet proper standards of accuracy and reliability
- Companies should establish procedures to ensure the fitness for use of instruments that generate data supporting product testing

Copley provides a range of qualification documentation, services and tools to meet these requirements.

See page 324 for further information.



Related Applications

We also offer a range of equipment for additional DPI testing application support:



For better *in vitro-in vivo* correlation (IVIVC) testing

See page 226



For USP product-specific monograph testing

See page 274

Automation Tools



Improve efficiency



Reduce variability



Eliminate handling errors



Increase testing capacity



DUSA Shaker™ DTS 100i

The DTS 100i automates the internal rinsing of the DUSA collection tubes for full, fast and repeatable drug dissolution and drug recovery.

See page 306 for further information.

Training, Servicing & Support

We offer a comprehensive range of services from bespoke product design to installation, expert training and technical support, optimising all aspects of pharmaceutical testing from start to finish.



Training

See page 335



Servicing

See page 330

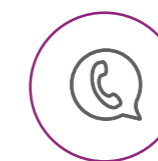

Support

See page 334



Design

See page 335



Delivered Dose Uniformity

Nebulisers

The delivered dose testing of nebulisers is carried out to determine the total amount of drug a patient might be expected to receive during a treatment period, rather than through one inhalation.

Given the mode of operation of nebulisers, well-defined tidal breathing profiles for specific patient types are specified for testing (see Table 2). These profiles can be reliably achieved using breathing simulators (see page 156).

Delivered Dose Testing Requirements for Nebulisers

The delivered dose of a nebuliser is quantified via two discrete metrics: **the active substance delivery rate** and the **total active substance delivered**.

To measure active substance delivery rate the output from the nebuliser is captured on a filter, under appropriate test conditions, over a specified time (typically 60 seconds). Replacing the filter and continuing the test until nebulisation stops, because the reservoir is empty, enables calculation of the second metric - total active substance delivered. This is the total mass collected during steps 1 and 2 of the test.

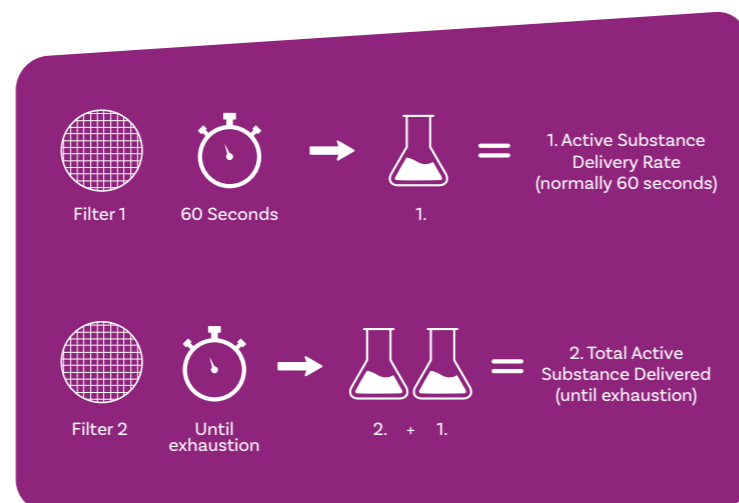

Regulations and Guidelines

The Advanced Filter Holder apparatus is used to perform those tests specified in the Pharmacopoeias relating to:

- Preparations for Nebulisation: Characterisation (Ph. Eur. 2.9.44)
- General Information: Products for Nebulization - Characterization Tests (USP <1601>)

Organisation	Chapter(s)/Guidance	Key DDU Tests listed
EMA	Guideline on the Pharmaceutical Quality of Inhalation and Nasal Products	<ul style="list-style-type: none"> • Drug Delivery Rate • Total Drug Delivered
Ph. Eur.	Chapter 2.9.44. Preparations for Nebulisation: Characterisation	Ph. Eur. : Active Substance Delivery Rate Total Active Substance Delivered
FDA	Guidance for Industry: Nasal Spray and Inhalation Solution, Suspension and Spray Drug Products - Chemistry, Manufacturing and Controls Documentation	Content Uniformity
USP	Chapter <1601> Products for Nebulization - Characterization Tests	Drug Substance Delivery Rate Total Drug Substance Delivered
Ch.P.	Chapter 0111	Delivered Dose Uniformity
JP	-	-

Table 2 : Breathing Simulator Specifications for Nebuliser Characterisation Tests

	Adult	Neonatal	Infant	Child
Total Volume	500 ml	25 ml	50 ml	155 ml
Frequency	15 cycles/min	40cycles/min	30 cycles/min	25 cycles/min
Waveform	Sinusoidal	Sinusoidal	Sinusoidal	Sinusoidal
I/E Ratio	1:1	1:3	1:3	1:2

DDU of Nebulisers Test System Set-Up

The sampling apparatus for nebulisers (mouthpiece-based products) consists of a breathing simulator to generate the specified breathing profile, a filter holder containing the filter to capture the delivered dose and a suitable mouthpiece adapter to connect the filter holder to the nebuliser under test.

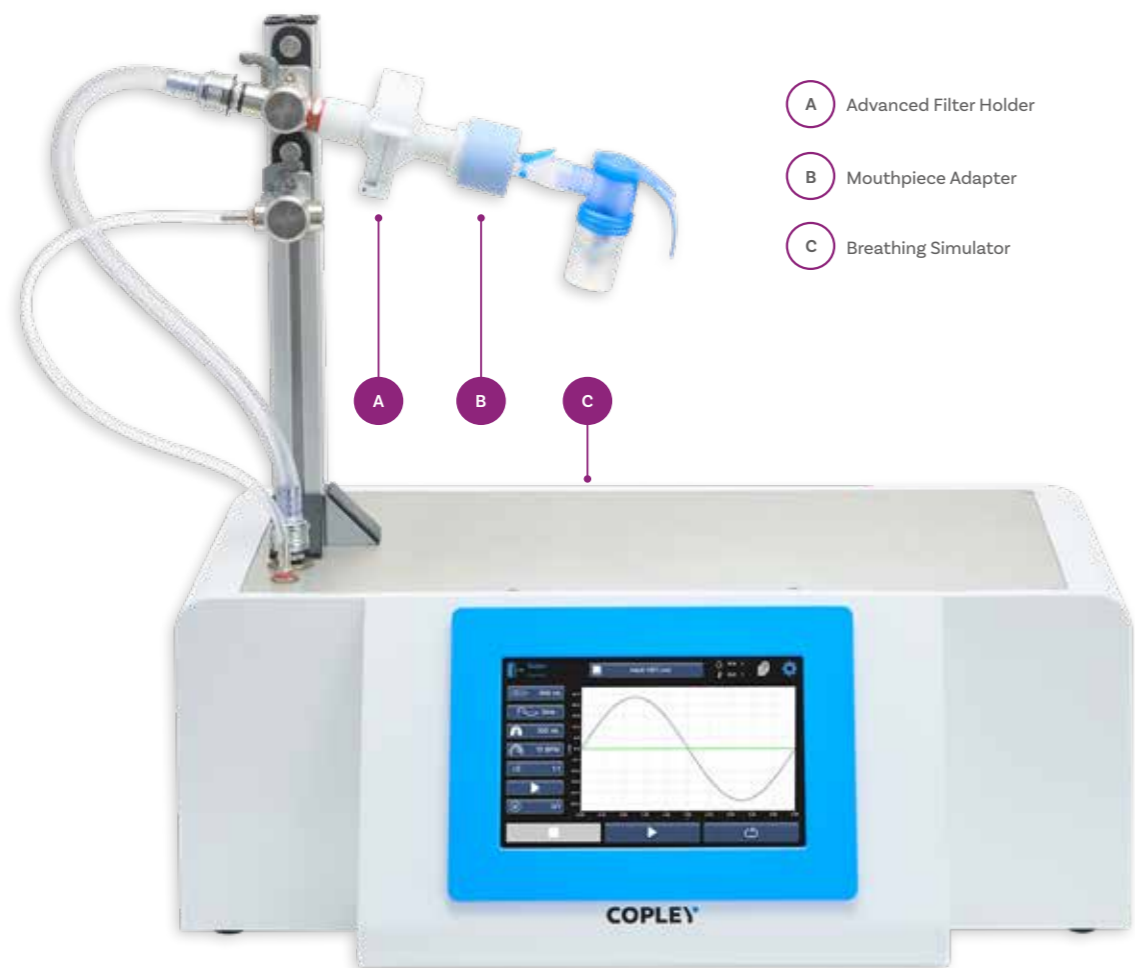

- A** Advanced Filter Holder
- B** Mouthpiece Adapter
- C** Breathing Simulator

Considering the effects of environmental variability?

Our environmental control solutions are designed to help improve the accuracy, sensitivity and reproducibility of test data.

Learn more on page 196.



DDU of Nebulisers: Test System Component Parts

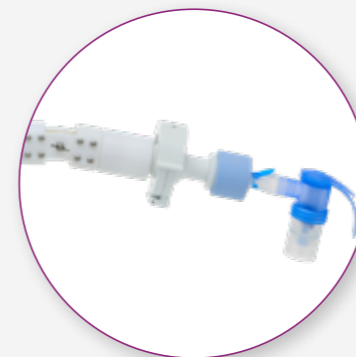

Advanced Filter Holder (with Angle Adapter and Adapter for Breathing Simulator Model BRS 100i)

See page 25.

In addition to the Filter Holder, the following is needed to complete a fully-operational test set-up for the delivered dose testing of nebulisers:

Breathing Simulator

Providing breathing profiles more representative of *in vivo* behaviour than conventional systems offering a constant flow rate, the Breathing Simulator BRS 200i is ideal for assessing the DDU of nebulisers.

A basic entry-level model, the Breathing Simulator BRS 100i, is also available.

Find out more about our range of Breathing Simulators on page 156.



BRS 200i



BRS 100i



Mouthpiece Adapter

Moulded from high quality silicone rubber, our Mouthpiece Adapters guarantee an airtight seal between the nebuliser and the test apparatus. For a list of available Mouthpiece Adapters See page 214.

Custom Mouthpiece Adapters are available upon request.

Qualification

GMP regulations require that

- The test methods used to monitor pharmaceuticals must meet proper standards of accuracy and reliability
- Companies should establish procedures to ensure the fitness for use of instruments that generate data supporting product testing



Copley provides a range of qualification documentation, services and tools to meet these requirements.

See page 324 for further information.

Related Applications

We also offer a range of equipment for additional nebuliser testing application support:



For better *in vitro-in vivo* correlation (IVIVC) testing
See page 226



For facemask testing
See page 250

Training, Servicing & Support

We offer a comprehensive range of services from bespoke product design to installation, expert training and technical support, optimising all aspects of pharmaceutical testing from start to finish.



Training
See page 335



Servicing
See page 330



Support
See page 334



Design
See page 335

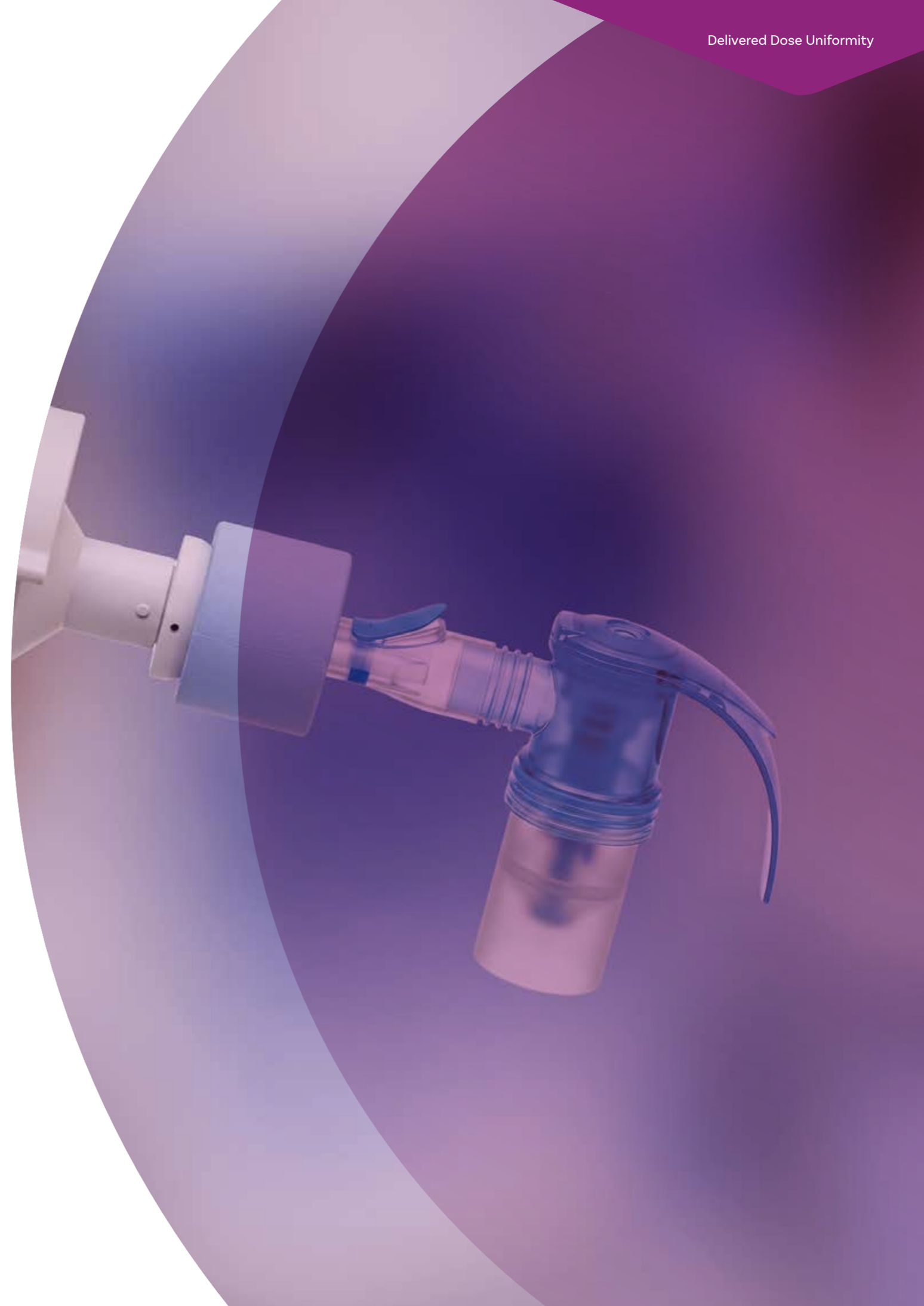



Delivered Dose Uniformity

Soft Mist Inhalers (SMIs)

Since they are active, aqueous-based devices, the DDU testing of SMIs is similar to that of MDIs, with testing carried out at a constant flow rate of 28.3 L/min.

Regulations and Guidelines

The sampling procedure and acceptance criteria for the DDU testing of SMIs varies according to the regulatory authority concerned.

Organisation	Chapter(s)/Guidance	Key DDU Tests
EMA	Guideline on the Pharmaceutical Quality of Inhalation and Nasal Products 2006	Delivered Dose Uniformity
Ph. Eur.	-	-
FDA	Guidance for Industry: Nasal Spray and Inhalation Solution, Suspension and Spray Drug Products - Chemistry, Manufacturing and Controls Documentation	Content Uniformity
USP	-	-
Ch.P.	Chapter 0111	Delivered Dose Uniformity
JP	-	-

DDU of SMIs Test System Set-Up

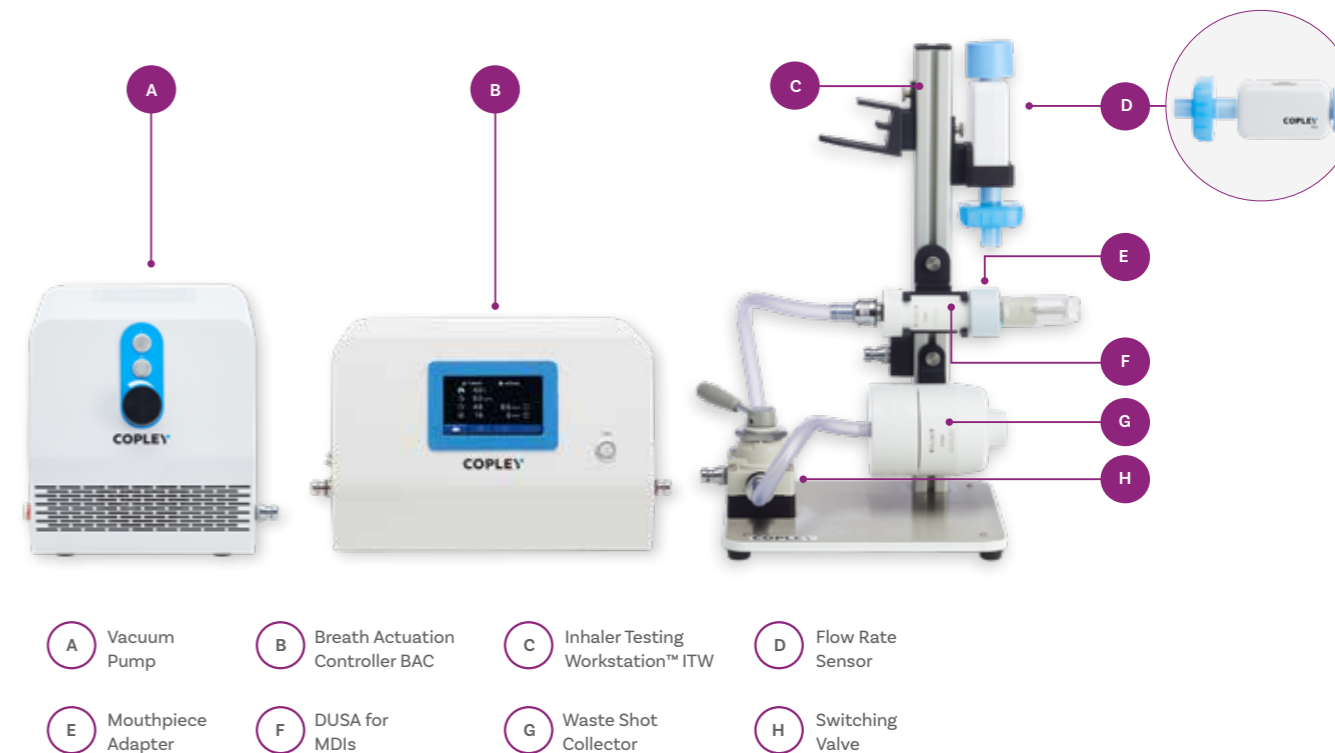

Considering the effects of environmental variability?

Our environmental control solutions are designed to help improve the accuracy, sensitivity and reproducibility of test data.

Learn more on page 196.



Related Accessories



DUSA Collection Tube Stand
Designed for the convenient transfer of multiple DUSA for MDIs around the laboratory. See page 22.



Temperature and Relative Humidity Sensor
Ideal for measuring environmental test conditions. See page 179.



Footswitch
Connecting directly to the Breath Actuation Controller BAC 100i, the Footswitch enables precise synchronisation of SMI device actuation with the onset of flow. See page 179.

DDU of SMIs: Test System Component Parts



Dose Uniformity Sampling Apparatus DUSA for MDIs

See page 20.

In addition to the DUSA for MDIs, the following is needed to complete a fully-operational test set-up for the delivered dose testing of SMIs:

Vacuum Pump

Designed for optimal operation at the low flow rates required for SMI testing, the Low Capacity Pump LCP7 represents the latest in high performance, low maintenance, vacuum pump technology. Our Vacuum Pump range is specifically designed for use in the testing of OINDPs in accordance with pharmacopoeial requirements.

See page 188 for further information about our Vacuum Pump range.



Breath Actuation Controller BAC

Ensuring that the volume of air sampled does not exceed pharmacopoeial specifications, the Breath Actuation Controller BAC 100i contains an electronically operated, timer-controlled two-way solenoid valve and is positioned between the DUSA and vacuum pump.

See page 172 for further information about our Flow Controller range.

Flow Rate Sensor FRS

Used for establishing accurate and consistent inlet flow rate during testing, the Flow Rate Sensor FRS measures flow rates to the accuracy specified by the pharmacopoeias.

See page 184 for further information about flow rate measurement.

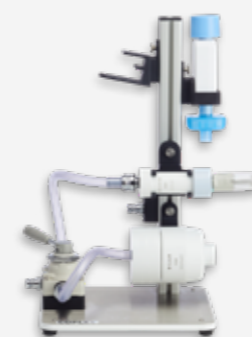

Inhaler Testing Workstation™ ITW

Designed to keep the sampling apparatus organised during testing and improve workflow efficiency, the ITW holds the DUSA collection tube, vacuum connector, flow meter and Waste Shot Collector WSC2.

See page 204 for further information.

Waste Shot Collector and Switching Valve

A compact vacuum filtration system, the Waste Shot Collector WSC2 captures aerosols emitted from repeated actuations of the inhaler, trapping large quantities of the drug for safe disposal. The Switching Valve is used to re-direct air flow between the collection device and WSC2 for quick and easy dose wasting. Please note: only required for multi-dose devices.

See page 24 for further information about the WSC2.



Mouthpiece Adapter

Moulded from high quality silicone rubber, our Mouthpiece Adapters guarantee an airtight seal between the inhaler under test and the test apparatus. For a list of available Mouthpiece Adapters see page 214.

Custom Mouthpiece Adapters are available upon request.

DDU Over the Entire Contents

In the case of multiple dose devices, tests might need to be carried out throughout the life of the inhaler, i.e. dose uniformity over the entire contents. For further information, see page 19.

Qualification

GMP regulations require that

- The test methods used to monitor pharmaceuticals must meet proper standards of accuracy and reliability
- Companies should establish procedures to ensure the fitness for use of instruments that generate data supporting product testing

Copley provides a range of qualification documentation, services and tools to meet these requirements.

See page 324 for further information.



Related Applications

We also offer a range of equipment for additional SMI testing application support:



For better *in vitro-in vivo* correlation (IVIVC) testing
See page 226



For USP product-specific monograph testing
See page 274

Automation Tools



Improve efficiency



Reduce variability



Eliminate handling errors



Increase testing capacity

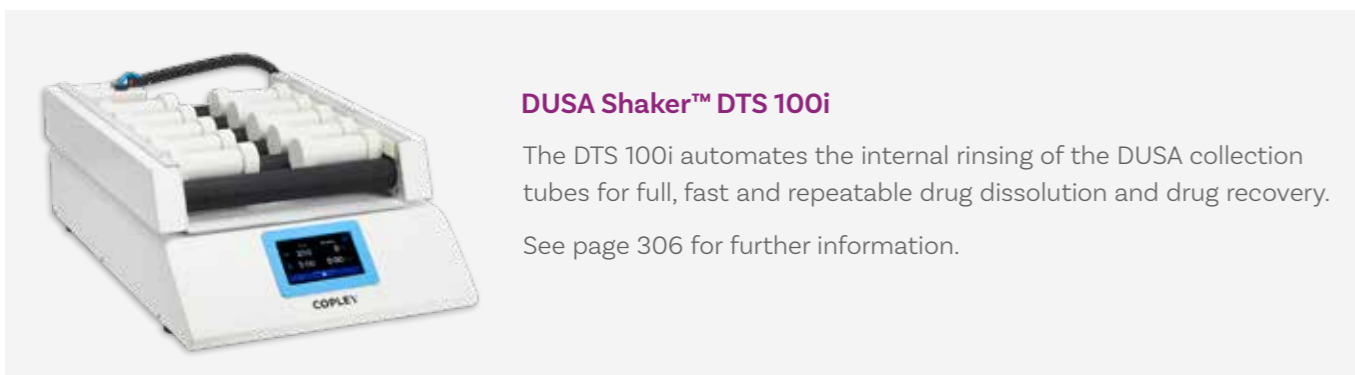

DUSA Shaker™ DTS 100i

The DTS 100i automates the internal rinsing of the DUSA collection tubes for full, fast and repeatable drug dissolution and drug recovery.
See page 306 for further information.

Training, Servicing & Support

We offer a comprehensive range of services from bespoke product design to installation, expert training and technical support, optimising all aspects of pharmaceutical testing from start to finish.



Training
See page 335



Servicing
See page 330



Support
See page 334



Design
See page 335





DDU of Nasal Sprays Automated Test System Set-Up

Routine DDU test set-ups for nasal sprays are easily automated with Vertus® III. Compatible with most nasal sprays, the Vertus III range simplifies the delivered dose uniformity testing of nasal sprays in accordance with Ph. Eur. Chapter 0676 and USP Chapter <601>.

The Vertus III range offers analysts complete control over:

- The speed, angle and duration of shaking, ahead of actuation
- Firing force and the speed of application and release of that force
- The time delay between the end of shaking and device actuation

- ✓ Improve nasal spray testing accuracy and reproducibility
- ✓ Replicate test methods across different sites with ease
- ✓ Reduce handling errors and costly out-of-specification results
- ✓ Increase productivity and reduce hassle

Delivered Dose Uniformity

Nasal Sprays

According to regulatory guidance, for the DDU testing of nasal sprays, the test unit should be actuated in a vertical or near-vertical, valve-up position with adequate controls over the critical mechanical actuation parameters, such as actuation force, speed and rest periods. USP <601> also requires the need for highly consistent actuation.

Regulations and Guidelines

The sampling procedure and acceptance criteria for the DDU testing of nasal sprays varies according to the regulatory authority concerned.

Organisation	Chapter(s)/Guidance	Key DDU Tests
EMA	Guideline on the Pharmaceutical Quality of Inhalation and Nasal Products	Delivered Dose Uniformity Through Container Life
Ph. Eur.	Uniformity of Delivered Dose of Inhalation and Nasal Preparations (Chapter 2.9.54)	Uniformity of Delivered Dose
FDA	Guidance for Industry: Nasal Spray and Inhalation Solution, Suspension and Spray Drug Products - Chemistry, Manufacturing and Controls Documentation	Content Uniformity
USP	Chapter <601> Inhalation and Nasal Drug Products: Aerosols, Sprays, and Powders - Performance Quality Tests	Delivered Dose Uniformity of Product
Ch.P.	Chapter 0111	Delivered Dose Uniformity
JP	-	-

Vertus III+ with DUSA Interface Plate

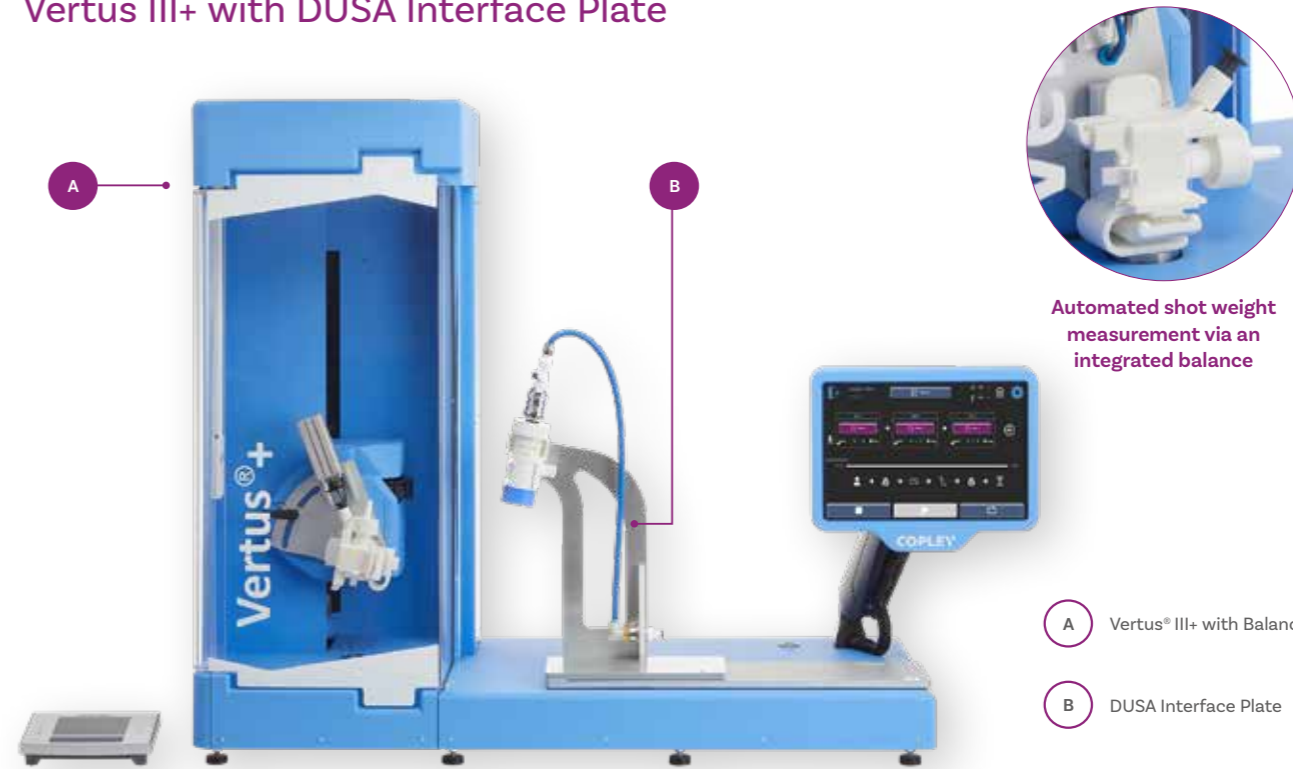

Automated shot weight measurement via an integrated balance

A Vertus® III+ with Balance

B DUSA Interface Plate

Nasal Spray Dose Collector NSDC



NSDC component parts

Nasal Spray Waste Collector (NSWC)

- A Vertus III Plus with Balance
- B Nasal Spray Dose Collector NSDC

For more information about the NSDC see page 28, and page 29 for the NSWC.

To find out more about our range of Automated Shake & Fire systems, see page 290.

Manual Test System Set-Up

As recommended in Ph. Eur. 0676 and USP <601>, we offer the Inhaler Testing Workstation™ ITW with a DUSA holder that can be oriented in a vertical or near-vertical position for more representative manual nasal spray DDU sampling. Product orientation for fire-to-waste should also match dose collection to help ensure data capture is more consistent and truly reflects performance with our innovative vertical Waste Shot Collector WSC2 attachment.

See page 26 for further information.

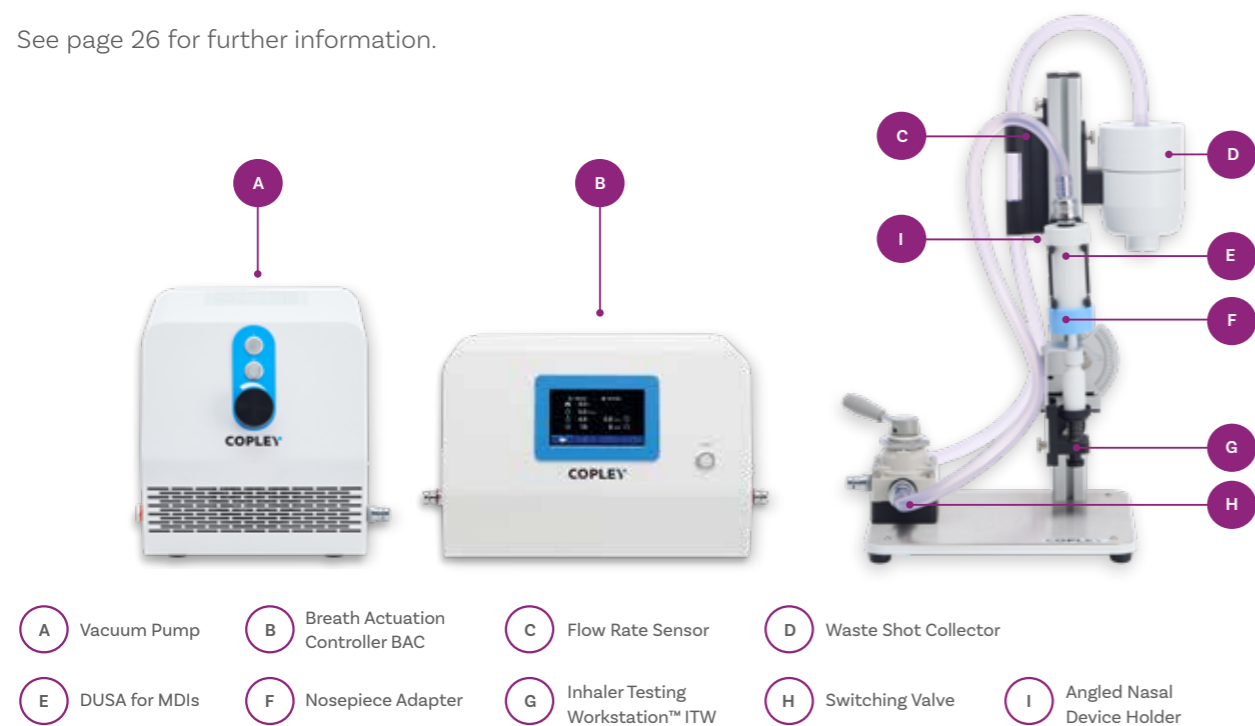

- A Vacuum Pump
- B Breath Actuation Controller BAC
- C Flow Rate Sensor
- D Waste Shot Collector
- E DUSA for MDIs
- F Nosepiece Adapter
- G Inhaler Testing Workstation™ ITW
- H Switching Valve
- I Angled Nasal Device Holder

Manual Test System Set-Up:
Alternative Dose Collection Devices



Kiel Nasal Inlet KNI
Page 212



Nasal Spray Dose Collector NSDC
Page 28

Considering the effects of environmental variability?

Our environmental control solutions are designed to help improve the accuracy, sensitivity and reproducibility of test data. Learn more on page 196.



DDU Over the Entire Contents

For more information about testing throughout the life of the nasal spray, in the case of multiple dose devices, i.e. dose uniformity over the entire contents, see page 19.

Qualification

GMP regulations require that

- The test methods used to monitor pharmaceuticals must meet proper standards of accuracy and reliability
- Companies should establish procedures to ensure the fitness for use of instruments that generate data supporting product testing

Copley provides a range of qualification documentation, services and tools to meet these requirements.

See page 324 for further information.



Automation Tools

- ✓ Improve efficiency
- ✓ Reduce variability
- ✓ Eliminate handling errors
- ✓ Increase testing capacity



DUSA Shaker™ DTS 100i

The DTS 100i automates the internal rinsing of the DUSA collection tubes for full, fast and repeatable drug dissolution and drug recovery.

See page 306 for further information.

Training, Servicing & Support

We offer a comprehensive range of services from bespoke product design to installation, expert training and technical support, optimising all aspects of pharmaceutical testing from start to finish.



Training
See page 335



Servicing
See page 330

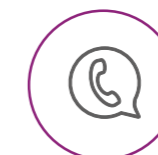

Support
See page 334



Design
See page 335

Delivered Dose Uniformity

Nasal Aerosols

DDU testing of nasal aerosols follows a similar process to that of MDIs (page 32), since both use a propellant to deliver a specified volume of active ingredient(s) upon actuation of a metered valve system. Testing is typically conducted at a fixed flow rate of 28.3 L/min using a DUSA for MDIs for sample collection.

Regulations and Guidelines

The sampling procedure and acceptance criteria for the DDU of nasal aerosols varies according to the regulatory authority concerned.

Organisation	Chapter(s)/Guidance	Key DDU Tests
EMA	Guideline on the Pharmaceutical Quality of Inhalation and Nasal Products	Delivered Dose Uniformity Through Container Life
Ph. Eur.	Uniformity of Delivered Dose of Inhalation and Nasal Preparations (Chapter 2.9.54)	Uniformity of Delivered Dose
FDA	Guidance for Industry: Metered Dose Inhaler (MDI) and Dry Powder Inhaler (DPI) Drug Products	Content Uniformity
USP	Chapter <601> Inhalation and Nasal Drug Products: Aerosols, Sprays, and Powders - Performance Quality Tests	Delivered Dose Uniformity of Product
Ch.P.	Chapter 0111	Delivered Dose Uniformity
JP	-	-

DDU of Nasal Aerosols Test System Set-Up

Routine DDU test set-ups for nasal aerosols are easily automated with Vertus® III. Compatible with most nasal aerosols, the Vertus III range simplifies the delivered dose uniformity testing of nasal aerosols in accordance with Ph. Eur. Chapter 0676 and USP Chapter <601>.

The Vertus III range offers analysts complete control over:

- The speed, angle and duration of shaking ahead of actuation
- Firing force and the speed of application and release of that force
- The time delay between the end of shaking and device actuation

- ✓ Improve nasal aerosol testing accuracy and reproducibility
- ✓ Replicate test methods across different sites with ease
- ✓ Reduce handling errors and costly out-of-specification results
- ✓ Increase productivity and reduce hassle

Vertus III+ with DUSA Interface Plate

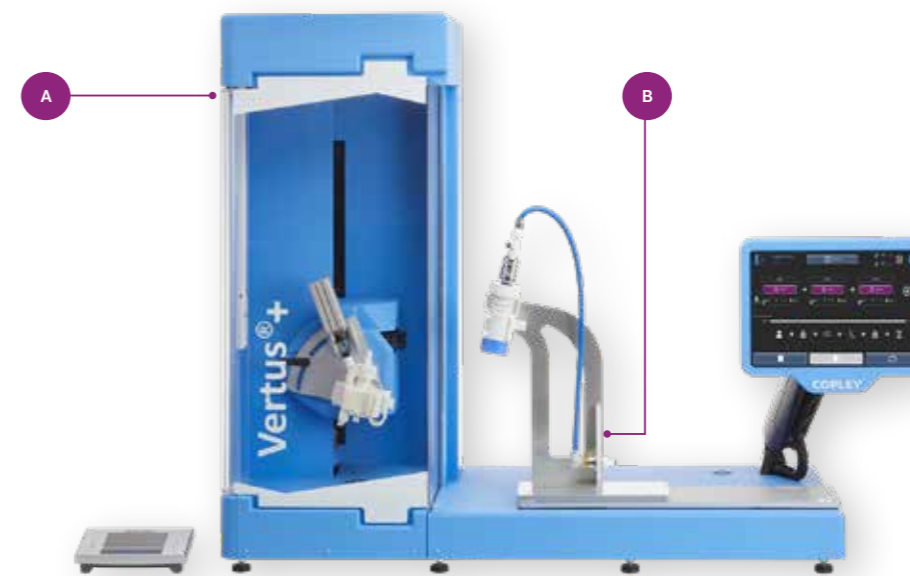

Automated shot weight measurement via an integrated balance

- A Vertus® III+ with Balance
- B DUSA Interface Plate

For more information about automation with the Vertus® range, see page 290.

Manual Test System Set-Up

As recommended in Ph. Eur. 0676 and USP <601>, we also offer the Inhaler Testing Workstation™ ITW with a DUSA holder that can be oriented in a vertical or near-vertical position for more representative manual nasal aerosol DDU testing. With our innovative vertical Waste Shot Collector WSC2 attachment, product orientation for fire-to-waste can also match dose collection to help ensure dose capture is more consistent and truly reflects performance.

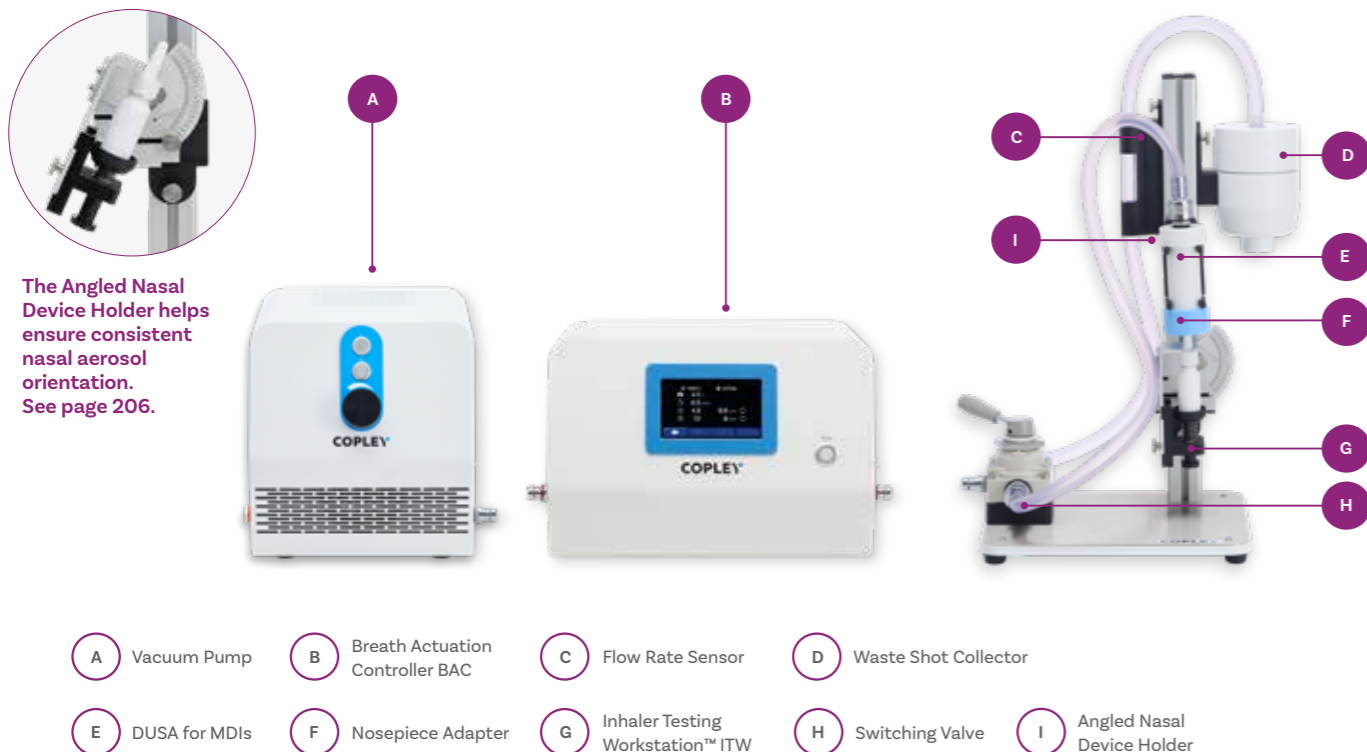

Considering the effects of environmental variability?
Our environmental control solutions are designed to help improve the accuracy, sensitivity and reproducibility of test data.
Learn more on page 196.



DDU Over the Entire Contents

For more information about testing throughout the life of nasal sprays, in the case of multiple dose devices, i.e. dose uniformity over the entire contents, see page 28.

Automation Tools

- Improve efficiency
- Reduce variability
- Eliminate handling errors
- Increase testing capacity

DUSA Shaker™ DTS 100i
The DTS 100i automates the internal rinsing of the DUSA collection tubes for full, fast and repeatable drug dissolution and drug recovery.
See page 306 for further information.

Training, Servicing & Support

We offer a comprehensive range of services from bespoke product design to installation, expert training and technical support, optimising all aspects of pharmaceutical testing from start to finish.

- Training**
See page 335
- Servicing**
See page 330
- Support**
See page 334
- Design**
See page 335



Delivered Dose Uniformity

Nasal Powders

The minimum requirements for nasal powder delivered dose testing are the same as for DPI testing (see page 46), namely DUSA, nosepiece adapter, vacuum pump and flow meter, plus a critical flow controller to measure the pressure drop across the device and control flow conditions during testing.

Regulations and Guidelines

The sampling procedure and acceptance criteria for the DDU testing of nasal powders varies according to the regulatory authority concerned.

Organisation	Chapter(s)/Guidance	Key DDU Tests
EMA	Guideline on the Pharmaceutical Quality of Inhalation and Nasal Products	Delivered Dose Uniformity Through Container Life
Ph. Eur.	Uniformity of Delivered Dose of Inhalation and Nasal Preparations (Chapter 2.9.54)	Uniformity of Delivered Dose
FDA	Guidance for Industry: Metered Dose Inhaler (MDI) and Dry Powder Inhaler (DPI) Drug Products	Content Uniformity
USP	Chapter <601> Inhalation and Nasal Drug Products: Aerosols, Sprays, and Powders - Performance Quality Tests	Delivered Dose Uniformity of Product
Ch.P.	Chapter 0111	Delivered Dose Uniformity
JP	-	-

DDU of Nasal Powders Test System Set-Up

The Angled Nasal Device Holder helps ensure consistent nasal powder orientation. See page 206.

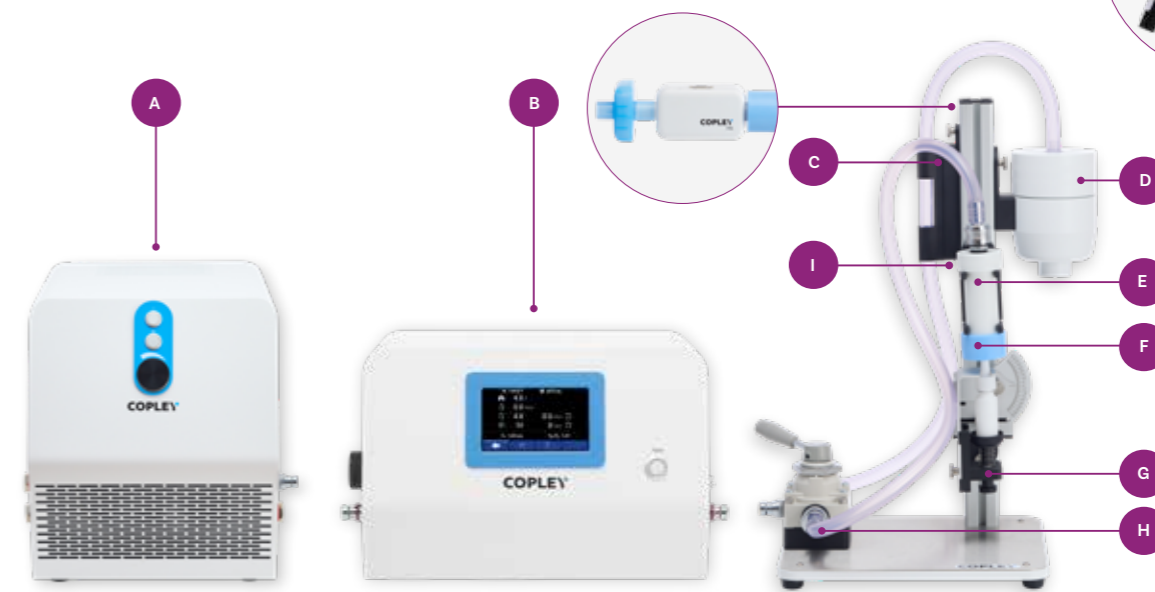

- A** Vacuum Pump
- B** Critical Flow Controller TPK
- C** Flow Rate Sensor FRS
- D** Waste Shot Collector
- E** DUSA for DPIs
- F** Nosepiece Adapter
- G** Inhaler Testing Workstation™ ITW
- H** Switching Valve
- I** Angled Nasal Device Holder

Considering the effects of environmental variability?

Our environmental control solutions are designed to help improve the accuracy, sensitivity and reproducibility of test data.

Learn more on page 196.



Related Accessories



DUSA Collection Tube Stand

Designed for the convenient transfer of multiple DUSA for DPIs around the laboratory. See page 23.



Temperature and Relative Humidity Sensor

Ideal for measuring environmental test conditions. See page 183.



Footswitch

Connecting directly to the Critical Flow Controller TPK 100i, the Footswitch enables precise synchronisation of nasal powder device actuation with the onset of flow. See page 183.

DDU of Nasal Powders: Test System Component Parts



Dose Uniformity Sampling Apparatus (DUSA) for DPIs

See page 22.

In addition to the DUSA for DPIs, the following is needed to complete a fully-operational test set-up for the delivered dose testing nasal powders:

Vacuum Pump

Ideal for the higher, sonic flow rate testing requirements of nasal powders, the High Capacity Pump HCP7 represents the latest in high performance, low maintenance, vacuum pump technology. Our Vacuum Pump range is specifically designed for use in the testing of OINDPs in accordance with pharmacopoeial requirements.

See page 188 for further information about our Vacuum Pump range.



Critical Flow Controller TPK

Simplify nasal powder test system set-up in accordance with pharmacopoeial recommendations with the Critical Flow Controller series. Positioned between the DUSA and vacuum pump, the Critical Flow Controller TPK 100i ensures critical (sonic) flow conditions during testing. It measures and records all required parameters required for testing and for controlling flow conditions.

See page 172 for further information about our Flow Controller range.



Flow Rate Sensor FRS

Used for establishing accurate and consistent inlet flow rate during testing, the Flow Rate Sensor FRS measures flow rates to the accuracy specified by the pharmacopoeias.

See page 184 for further information about flow rate measurement.



Inhaler Testing Workstation™ ITW

Designed to keep the sampling apparatus organised during testing and improve workflow efficiency, the Inhaler Testing Workstation ITW holds the DUSA collection tube, vacuum connector, flow meter Waste Shot Collector WSC2.

See page 204 for further information.

Waste Shot Collector and Switching Valve

A compact vacuum filtration system, the Waste Shot Collector WSC2 captures aerosols emitted from repeated actuations of the inhaler, trapping large quantities of the drug for safe disposal. The Switching Valve is used to re-direct air flow between the collection device and WSC2 for quick and easy dose wasting. Please note: only required for multi-dose devices.

See page 28 for further information about the WSC2.

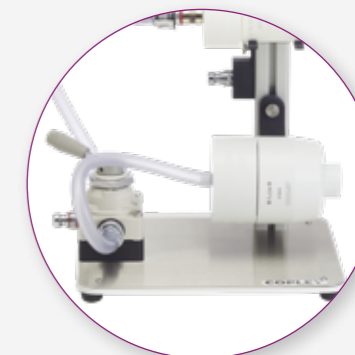

Nosepiece Adapter

Special nosepiece adapters are available to accommodate the nasal powder device and interface it with the test set-up.

See page 214 for further information.

DDU Over the Entire Contents

In the case of multiple dose devices, tests might need to be carried out throughout the life of the nasal powder, i.e. dose uniformity over the entire contents. For further information, see page 28.

Qualification

GMP regulations require that

- The test methods used to monitor pharmaceuticals must meet proper standards of accuracy and reliability
- Companies should establish procedures to ensure the fitness for use of instruments that generate data supporting product testing

Copley provides a range of qualification documentation, services and tools to meet these requirements.

See page 324 for further information.



Automation Tools

-  Improve efficiency
-  Reduce variability
-  Eliminate handling errors
-  Increase testing capacity



DUSA Shaker™ DTS 100i

The DTS 100i automates the internal rinsing of the DUSA collection tubes for full, fast and repeatable drug dissolution and drug recovery.

See page 306 for further information.

Training, Servicing & Support

We offer a comprehensive range of services from bespoke product design to installation, expert training and technical support, optimising all aspects of pharmaceutical testing from start to finish.



Training
See page 335



Servicing
See page 330



Support
See page 334



Design
See page 335

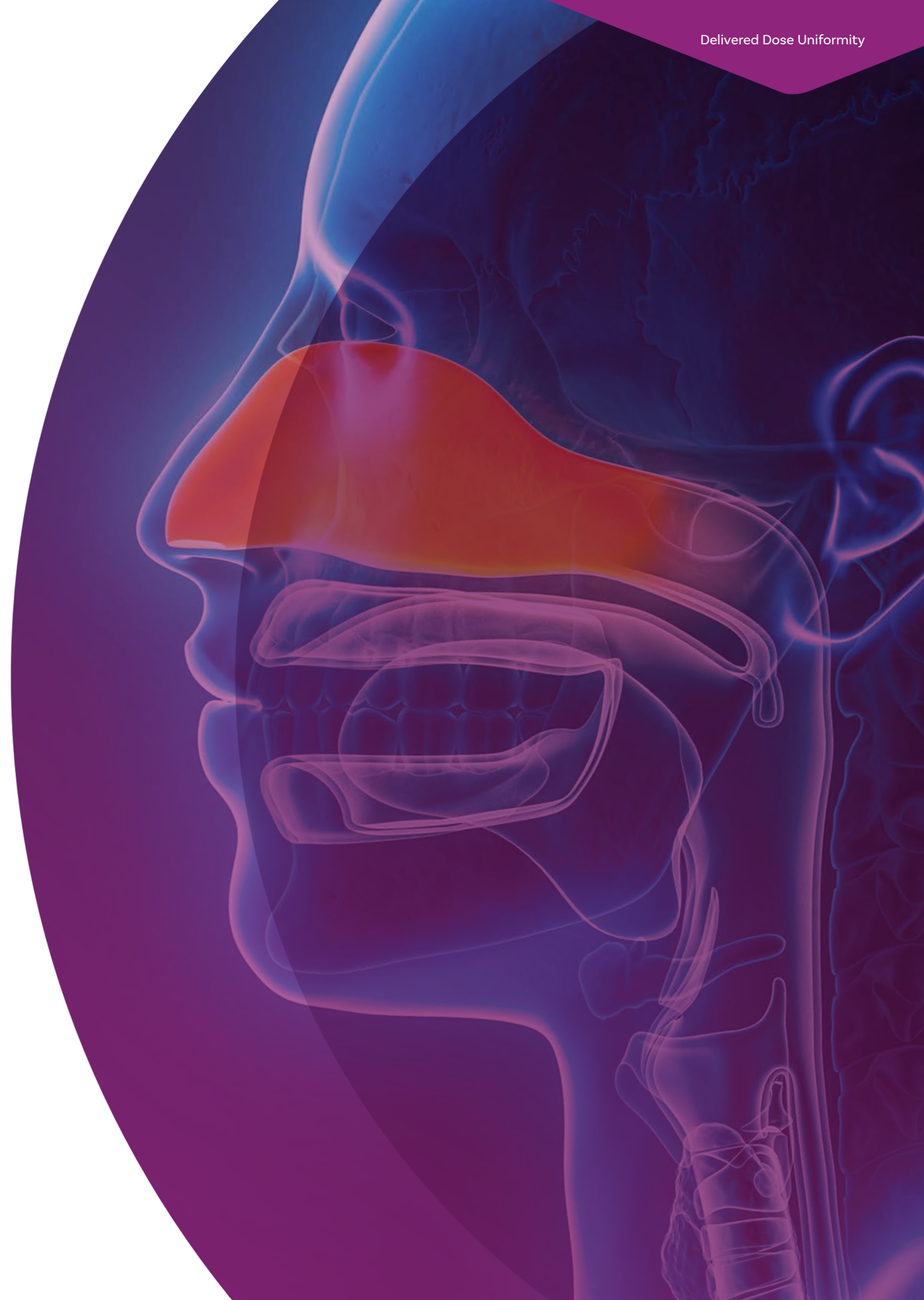

Aerodynamic Particle Size Distribution

Together with delivered dose, aerodynamic particle size distribution (APSD) is typically identified as a **Critical Quality Attribute (CQA)** for orally inhaled and nasal drug products (OINDPs) making it a primary focus for *in vitro* characterisation. The APSD of an OINDP defines how particles behave in a moving air stream. It is intuitively relevant to the understanding of likely lung deposition and hence potential drug efficacy.

To be therapeutically effective, inhaled drug particles should ideally be in the range of 1 to 5 microns to deposit in the lungs. Particles more than 5 microns will generally impact in the oropharynx and be swallowed, whereas below 1 micron particles will likely remain

entrained in the air stream and be exhaled. The mass of dose delivered at a particle size below 5 microns is normally described as the fine particle mass (FPM) or dose (FPD) and is an important metric for OIPs.

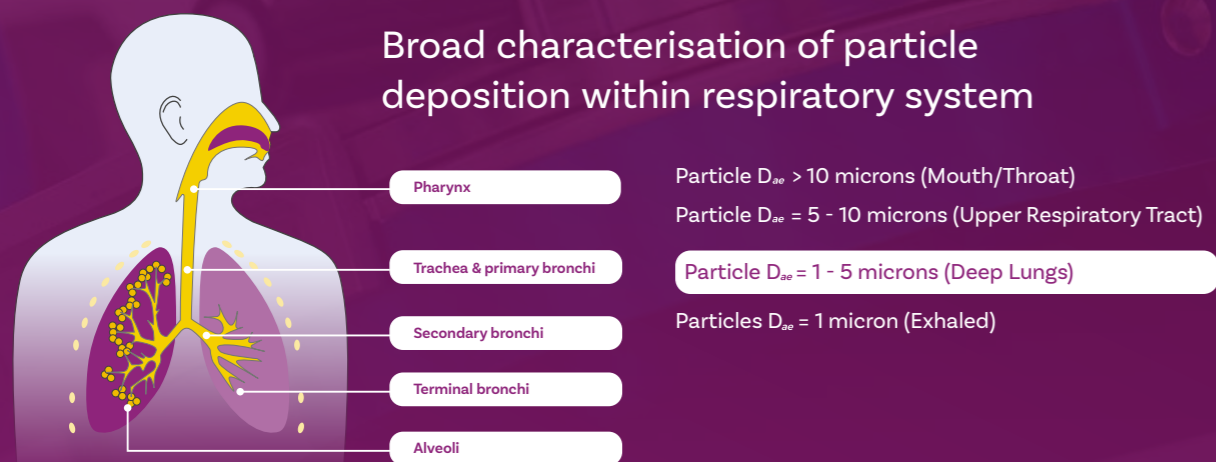

TOP TIP

Aerodynamic diameter (D_{ae}) is the diameter of a sphere of unit density whose behaviour in an air-stream is the same as the drug particle.

$$D_{ae} = D_p^{1/2} f(S)$$

- D = Geometric diameter
- ρ = Particle density
- S = Shape factor

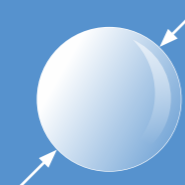

$D = 3 \mu\text{m}$
 $D_{ae} = 3 \mu\text{m}$



$D = 1 \mu\text{m}$
 $D_{ae} = 3 \mu\text{m}$

An Introduction to Cascade Impaction

The cascade impactor is the instrument of choice for both regulators and pharmacopoeias when measuring the APSD of inhaled drug products due to some unique features. Cascade impactors separate a sample on the basis of particle inertia (which is a function of velocity and aerodynamic particle size) without the need to know either particle density or shape.

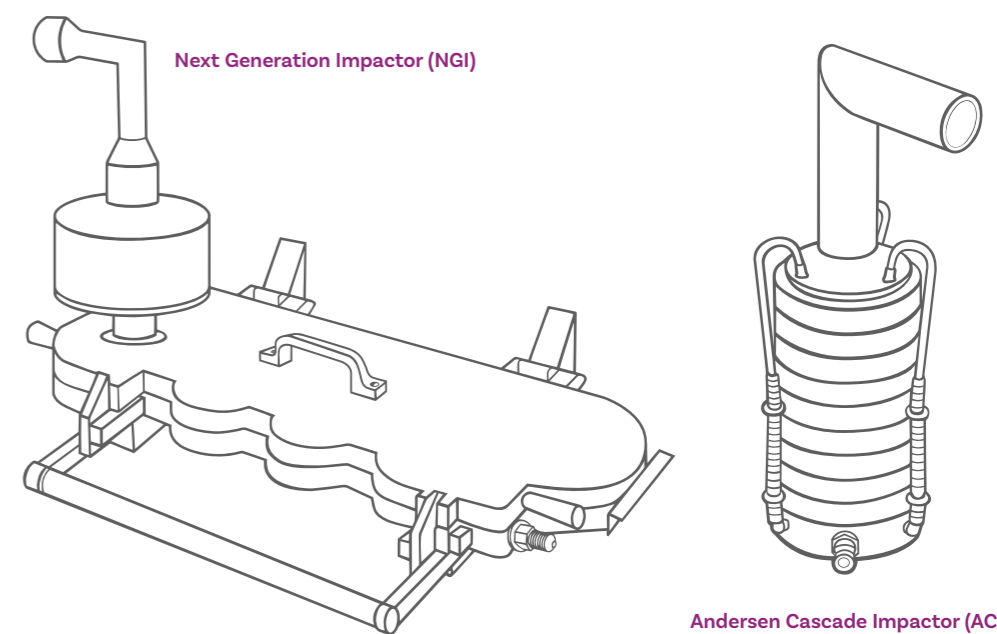

TOP TIP

The term "impactor" is generally used for an instrument where the particles "impact" on a dry impaction plate or cup. The term "impinger" is used to describe instruments where the particles impinge into a liquid or onto a moist collection surface.

Cascade impactors have three unique features which make them the ideal tool for particle size assessment of inhaled products.

1. Cascade impactors measure aerodynamic particle size data

Cascade impactors measure aerodynamic particle size which is a function of particle density, as well as the physical dimensions and shape of the particles concerned. This is a more relevant parameter when studying how particles behave in a moving air stream (as exemplified by the respiratory tract) rather than simple “geometric” size.

2. Cascade impactors deliver active pharmaceutical ingredient (API) specific measurements

Cascade impactors provide a direct means of recovering and quantifying API contained in the aerosol cloud. The aerosol clouds generated by pharmaceutical inhalers typically comprise a combination of API(s) and other excipients or components, but it is the size distribution of the API that influences efficacy. Cascade impaction generates an APSD specifically for the API to meet this informational need.

3. Cascade impactors capture the entire dose

Cascade impactors, unlike other sizing techniques, which just provide a snapshot of part of the dose, capture the entire dose allowing complete characterisation of the aerosol under test.

The pharmacopoeias recommend a number of commercially available impactors for the routine testing of OINDPs including the Next Generation Impactor (NGI) and the Andersen Cascade Impactor (ACI), both of which are used globally for the testing of metered-dose inhalers (MDIs), dry powder inhalers (DPIs) and soft mist inhalers (SMIs).

Induction Port

For most inhaler-related applications, the inlet to the impactor is fitted with a right-angled induction port designed to act as a simplified throat. The dimensions of this induction port are standardised between the various pharmacopoeias and serve to ensure that the aerosol cloud produced by the inhaler is sampled in a reproducible manner.

Mouthpiece Adapter

The inhaler is connected to the induction port by means of a mouthpiece adapter which provides an airtight seal between the induction port and the device under test.

Vacuum Pump

Once discharged from the inhaler, the aerosol cloud is drawn through the impactor by means of a vacuum pump connected to the outlet of the impactor by a suitable length of tubing.

Cascade Impactor

Consists of one or more stages normally arranged in the form of a ‘stack’, which can be vertical or horizontal. These separate the particles entrained in the aerosol stream, into a series of size bands or fractions in the respirable range, broadly corresponding to their likely deposition sites in the respiratory tract.

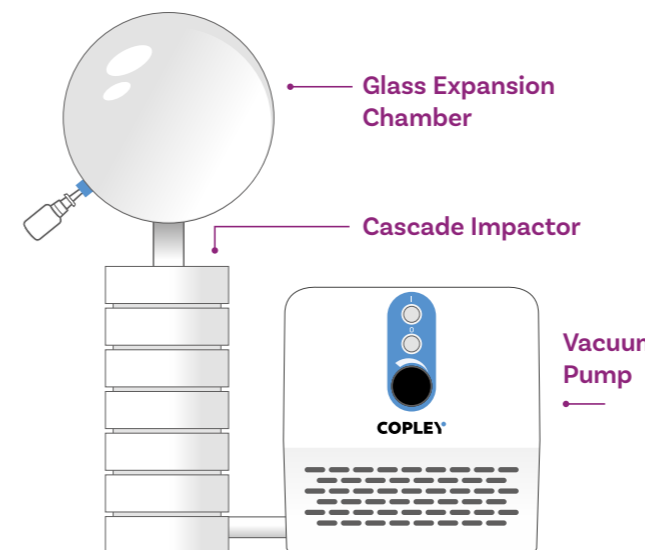
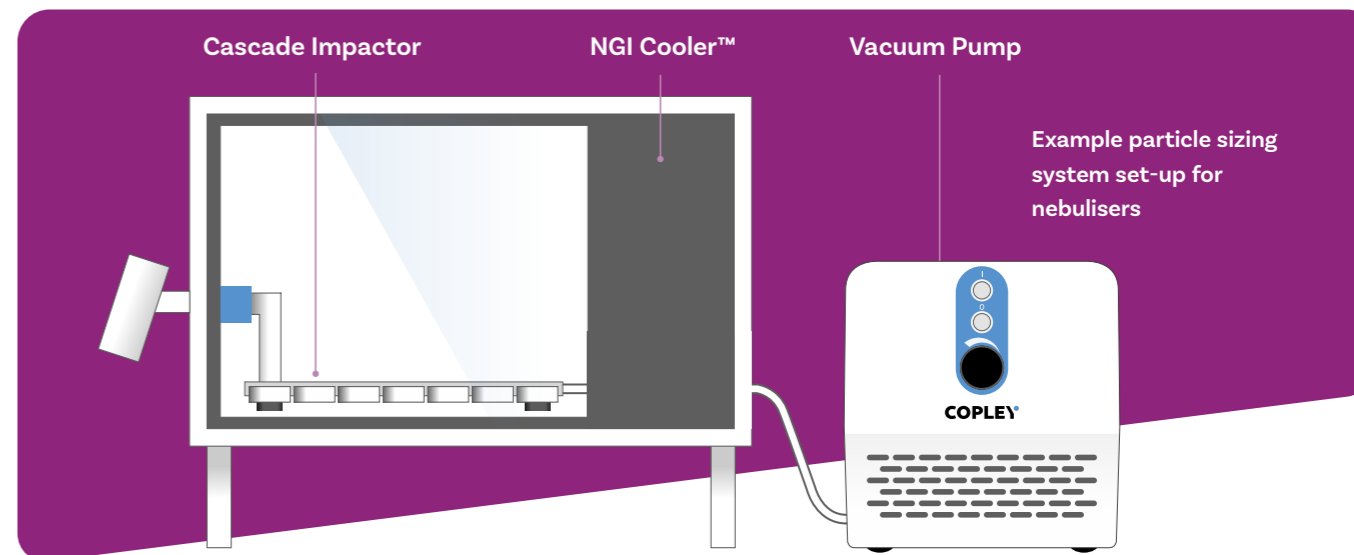
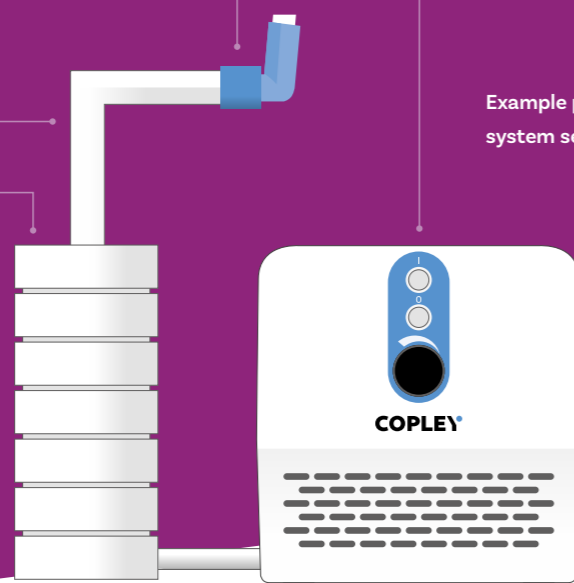

Example particle sizing system set-up for nasal products

TOP TIP

A cascade impactor, contrary to common understanding, is not a lung simulator. The lung is a complex organ, with high humidity, decreasing velocity with each bifurcation and complex deposition mechanisms (diffusion and sedimentation, as well as impaction). A cascade impactor is a highly discriminatory, reproducible measure of relative product difference and is therefore ideally suited to quality control and *in-vitro* bioequivalence applications. Enhancements to improve the clinical realism of testing, in-line with improving *in vitro-in vivo* correlations (IVIVCs), can be found on page 222.

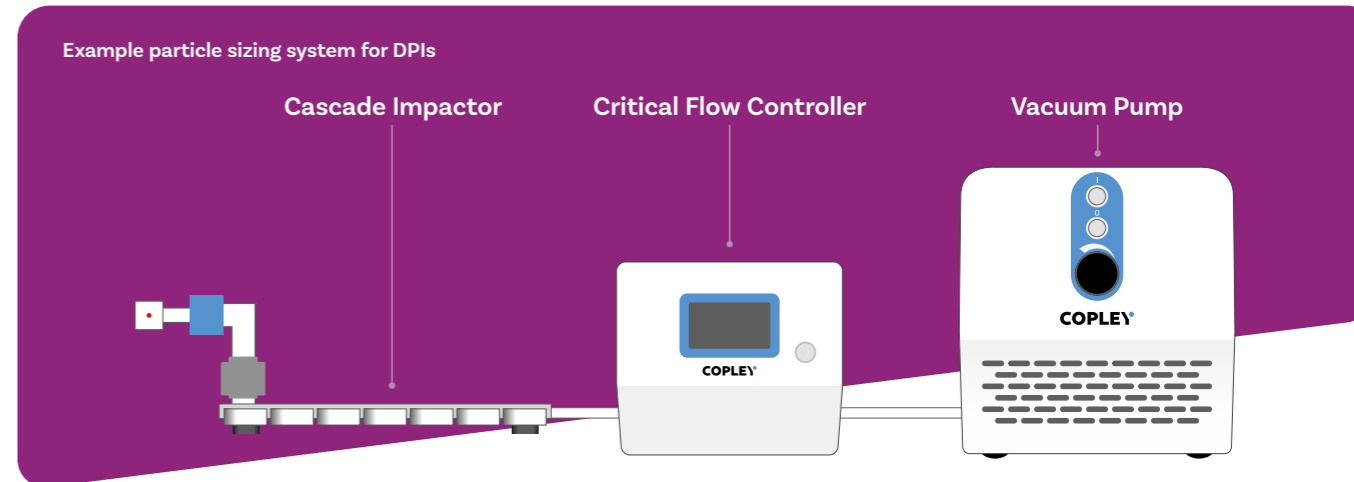

Example particle sizing system for DPIs

How Does a Cascade Impactor Work?

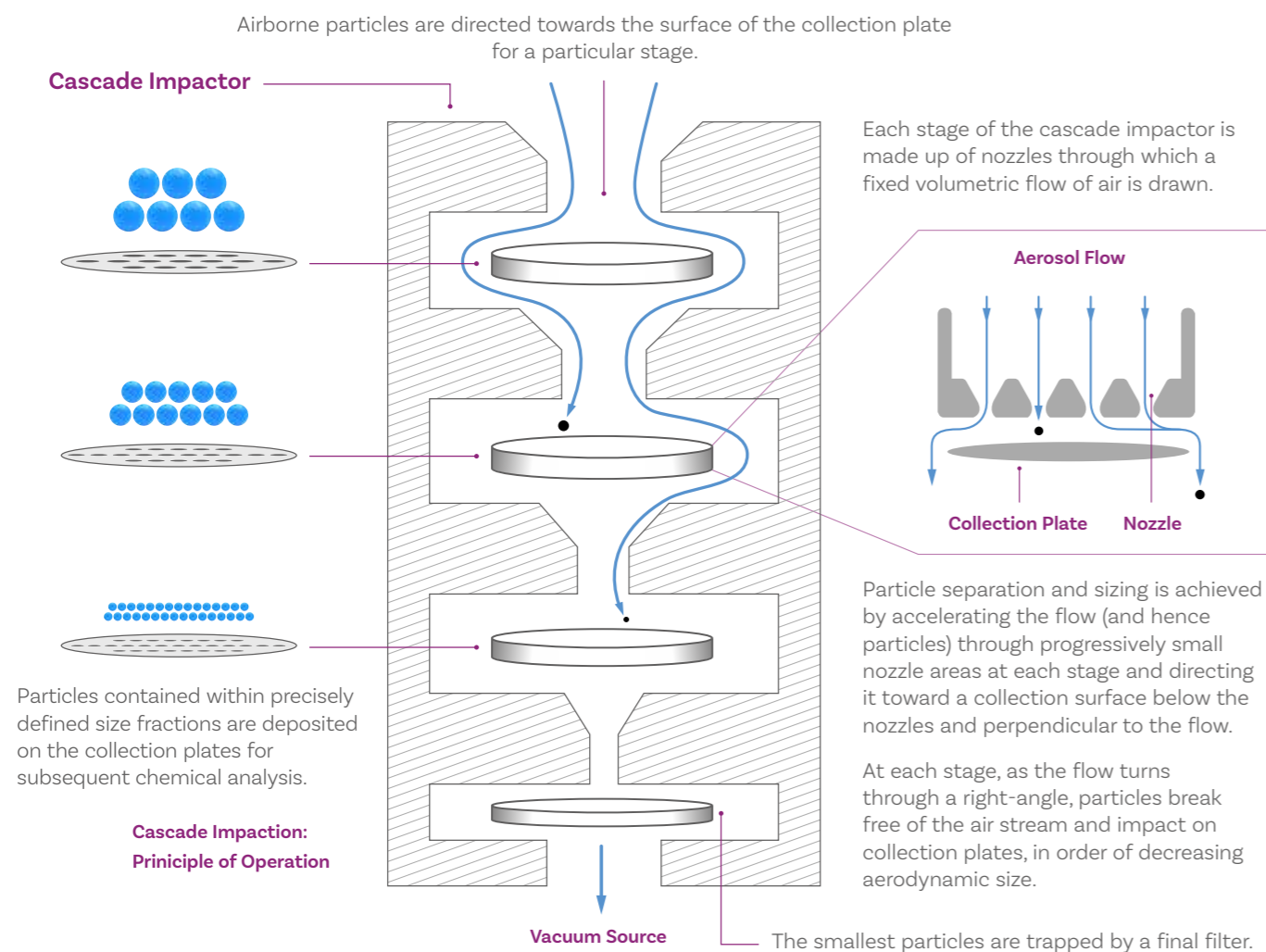

Other Considerations



Impactor Mensuration

Stage mensuration replaces the need for repetitive calibration using standardised aerosols and ensures that only impactors conforming to specification are used in testing. It involves individually inspecting every jet on every stage of the impactor to ensure compliance. Mensuration should be conducted at least annually to ensure the impactor remains in conformance and to assess if any stages might require intervention or repair.

All cascade impactors (including induction ports and preseparators), supplied by Copley, are checked at every stage of manufacture using the very latest in metrology equipment and are provided with a mensuration certificate prior to release.

To find out more about our Servicing options, please see page 330.



Impactor Leak Testing

The ability of a cascade impactor to accurately size separate particles relies on maintaining a fixed volumetric flow rate of air through it. Leaks between impactor stages that allow air to become entrained into the impactor from the outside can modify this flow rate and cause incorrect particle sizing. Performing a leak test prior to each test is recommended to ensure data integrity.

To find out more about our Impactor Leak Testing Kit, please see page 332.



Impactor Cleaning

Cascade impactors are precision instruments and should be treated with care. Regular cleaning and drying is an essential element of good impactor practice and ensures that the instrument is free of product residue and debris prior to testing and that the unit remains in optimum condition throughout its life.



To find out more about our Impactor Cleaning System, please see page 320.

Connected Data Management: Inhalytix[®]+

Following cascade impaction, the mass of drug collected at each stage is recovered and quantified, typically using HPLC. From this assay data, pharmacopoeial metrics such as Fine Particle Dose (FPD), Fine Particle Fraction (FPF), Mass Median Aerodynamic Diameter (MMAD) and Geometric Standard Deviation (GSD) must be calculated to characterise APSD in accordance with regulatory guidance.

Inhalytix+ is a fully validated data management platform designed specifically for inhaler testing applications. It automates the structured transformation of raw stage-by-stage assay data into performance-defining aerodynamic metrics, supporting accurate, consistent and regulatory-aligned reporting.

The software supports integration with compatible Copley ancillary and automation tools, enabling automatic capture of selected operational parameters and equipment metadata as part of a connected workflow.

-  Automated APSD metric calculation
-  Standardised data handling and reporting
-  Secure and compliant data management
-  Equipment metadata integration



Learn more about Inhalytix+ on page 218.

Copley supports APSD assessments through a connected portfolio of impactors, flow control instrumentation, automation tools and validated data management software. Together, these components provide a structured and reproducible approach to APSD measurement, from sample collection through to regulatory-ready reporting.



Types of Cascade Impactor



Next Generation Impactor (NGI)

The NGI is a high performance, precision cascade impactor suitable for the APSD characterisation of all types of OINDPs. Ideal for testing at all flow rates specified in the relevant pharmacopoeias, the highly flexible NGI is the cascade impactor of choice for many laboratories throughout the world.



Meets and exceeds all Ph.Eur. and USP specifications



Low inter-stage wall losses for good drug recovery (mass balance)

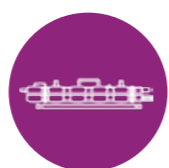

Seven stages; five with cut-offs between 0.54 and 6.12 microns at flow rates from 30 to 100 L/min



Electrically conductive; unaffected by static



Excellent stage efficiency (GSD <1.2), accuracy and reproducibility



User friendly design for maximum throughput and easy automation

NGI: Key Features

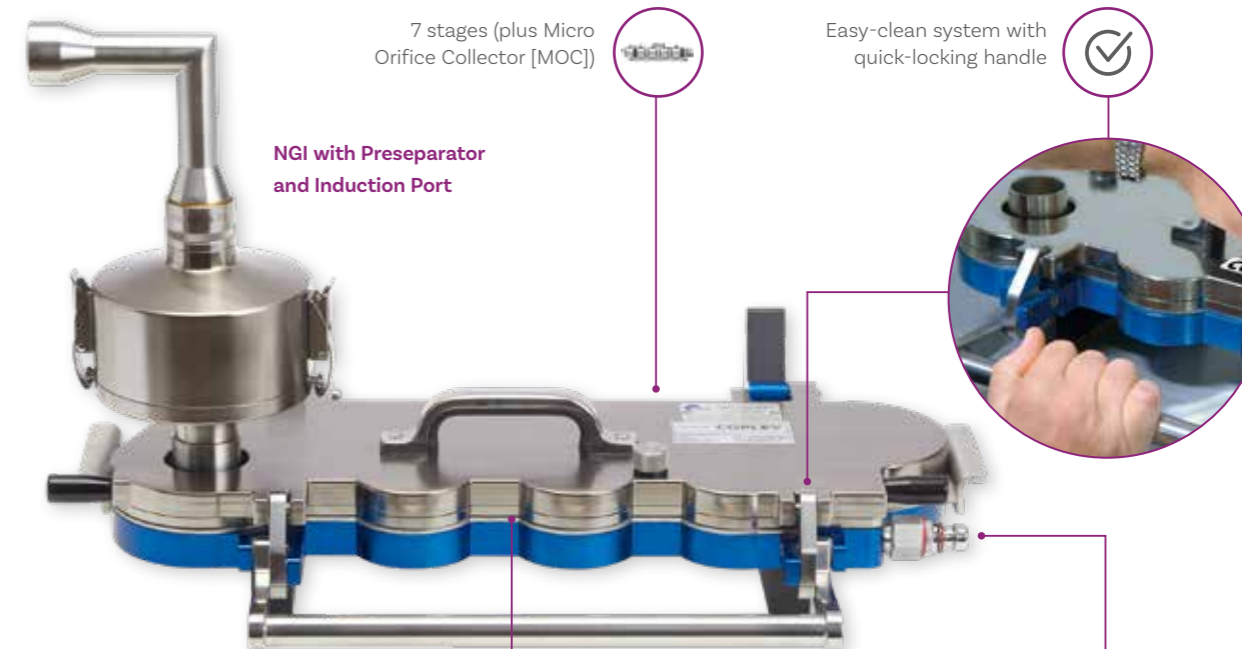

TOP TIP

The NGI+ provides improved robustness for higher workloads and supports the use of saline solution-based products and harsher chemical solvents. The stainless steel seal body of the NGI+ makes it ideal for a wider range of testing applications.



Operation between 15 and 100 L/min

A Quick-Release Connector is supplied as standard



NGI: Materials of Construction

NGI+: 316 Stainless Steel Seal Body Superior corrosion resistance and durability to extend impactor life.

NGI: Nickel Plated Aluminium Seal Body Lighter weight, where corrosion resistance is not a significant issue.

NGI (open)



Removable seal body (containing all nozzle pieces) for easy impactor cleaning

Removable cup tray - just lift and remove complete set of collection cups

A horizontal planar layout for ease of operation and automation

Low inter-stage losses and minimal particle carry-over mean that only the cups and trays need changing between tests

The sample-laden air flow passes through the NGI in a saw-tooth pattern across stages arranged in a horizontal plane.

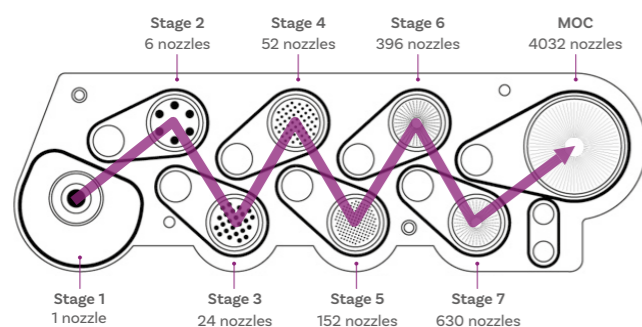

NGI Principle of Operation

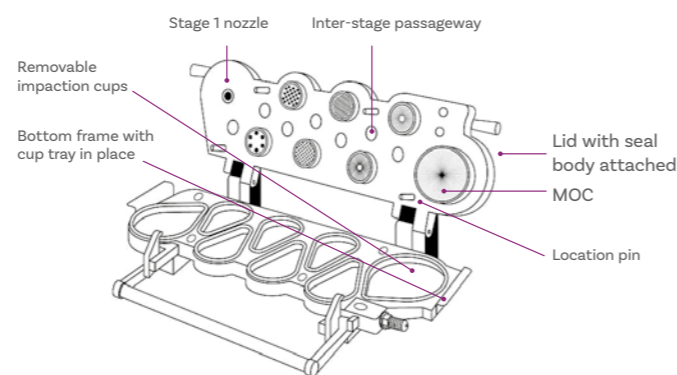

Schematic of Seal Body Showing Orientation of the Various Stages

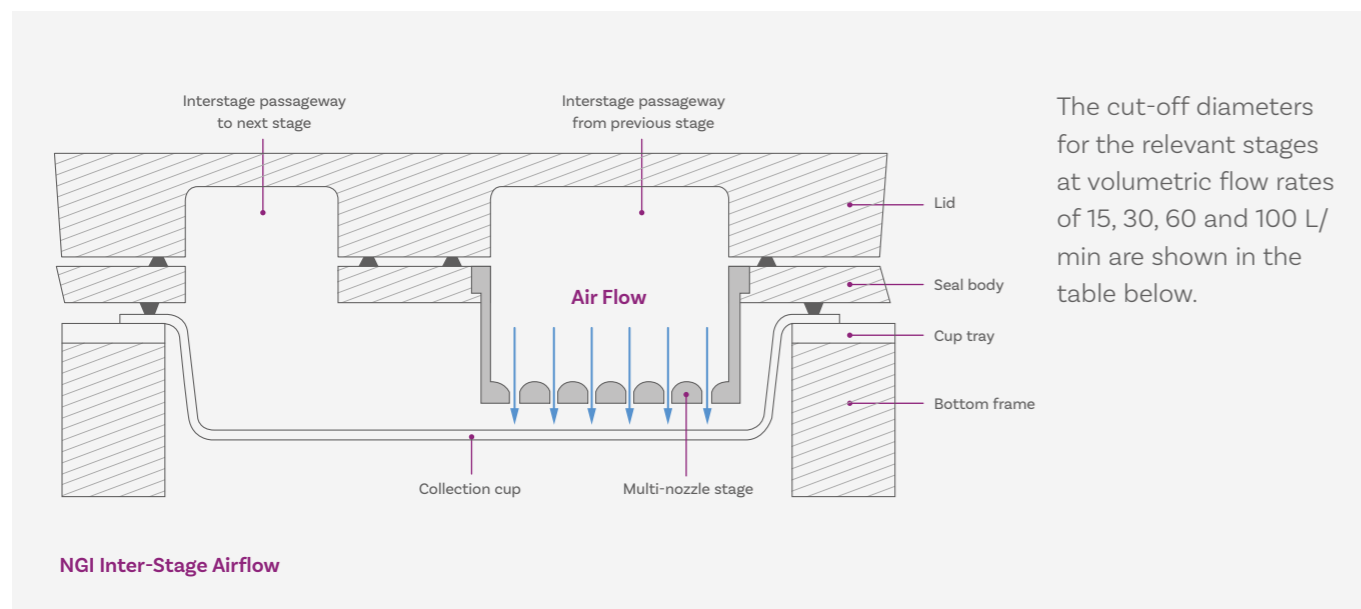

NGI Inter-Stage Airflow

The cut-off diameters for the relevant stages at volumetric flow rates of 15, 30, 60 and 100 L/min are shown in the table below.

NGI Cut-Off Diameters

	15	30	60	100	L/min
Stage 1	14.10	11.72	8.06	6.12	microns
Stage 2	8.61	6.40	4.46	3.42	microns
Stage 3	5.39	3.99	2.82	2.18	microns
Stage 4	3.30	2.30	1.66	1.31	microns
Stage 5	2.08	1.36	0.94	0.72	microns
Stage 6	1.36	0.83	0.55	0.40	microns
Stage 7	0.98	0.54	0.34	0.24	microns

TOP TIP

Automation: The 3-part construction of the NGI makes it ideal for automation. See page 286 for further information on our automation solutions.

NGI: Component Parts

A number of supporting component parts are required in addition to the NGI itself:

NGI Induction Port

Manufactured from 316 stainless steel, the tapered and hardened outlet of the NGI Induction Port provides an airtight seal with the inlet to Stage 1 and the mouthpiece adapter.

NGI Preseparator

The NGI requires the use of a preseparator when used with DPIs in order to catch any powder boluses and large non-inhalable particles. Offering high capacity, high efficiency, two-stage separation, the NGI Preseparator provides a sharp and reproducible cut-point of between 10 and 15 microns depending on flow rate.

Filter Holder

In most cases, the MOC eliminates the need for a final paper filter, having an 80% collection efficiency of 0.3 micron particles at 30 L/min. If ultra-fine particles are present and at flow rates below 30 L/min, then an internal or external filter holder can be used.

Sample Collection Cups

Four special types of sample collection cups are available in addition to those supplied as standard with the NGI:

- Gravimetric Cup** - for APSD determinations based on sample weight
- Deep Cup** - to bypass a stage, obviating impaction
- Exhaust Cup** - to bypass a downstream portion of the impactor
- Glass Disc Cup** - for Malvern Panalytical Morphologi system

NGI: Accessories



NGI Cup Rack

For the convenient storage of a full set of NGI Cups, protecting the critical surfaces from inadvertent damage and dust collection when not in use.

NGI Carrying/Wash Rack

For transporting the NGI system components around the laboratory and storing them, protecting the critical surfaces from damage and scratches. The rack is also designed to hold the components in place when using our Impactor Cleaning System.



Rinsing Caps

Silicone Rubber and 316 Stainless Steel Rinsing Caps are available for capping off the open ends of the NGI Induction Port and the NGI Preseparator during manual and automated drug recovery.

Storage Cabinet for Impactor Collection Trays

Accommodates up to six NGI Collection Cup Trays (NGI Collection Cup Trays not included).

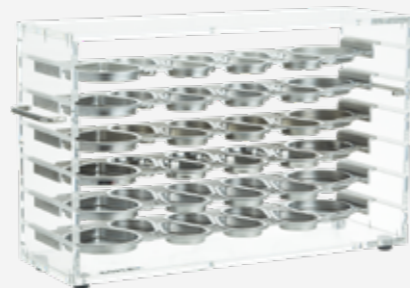

TOP TIP

All NGIs supplied by Copley are machined to the same precision tolerances to guarantee reproducibility between impactors. Each NGI is supplied with a full stage mensuration report (system suitability).

Recommended annually, NGI stage mensuration replaces the need for repetitive, difficult and typically unreliable calibration and ensures that only impactors conforming to specification are used in testing.

For more information on our Servicing options, see page 330.

Further details regarding the design and archival calibration of the NGI can be found in the Journal of Aerosol Medicine Volume 16(3), 2003 and Volume 17(4), 2004.

NGI: Technical Specifications

Flow Rate Range	15 - 100 L/min
Particle Size Range	0.24 - 14.1 microns (dependent on flow rate)
Number of Stages	7
Operation Method	Impaction
Inter-Stage Losses	Low (<5%)
Method of Drug Assay	Chemical analysis - HPLC - Ultra Performance Liquid Chromatography (UPLC) - Infrared Spectroscopy (IR)
Material(s) of Construction	Nickel Plated Aluminium or 316 Stainless Steel

Next Generation Impactor (NGI)

Impactors

Cat. No.	Description
5201	Next Generation Impactor (NGI)
5201A	NGI+ Next Generation Impactor
5202	NGI+ Next Generation Impactor Upgrade

Component Parts

Induction Ports

5203	NGI Induction Port
5239	FRS Flow Meter Adapter
5238	DFM Flow Meter Adapter

Preseparators for testing DPIs

5204	NGI Preseparator (Nickel Plated Aluminium)
5204A	NGI Preseparator with Stainless Steel Insert

Filter Holders

5206	Internal Filter Holder
5210	External Filter Holder
5240	Box of 100 Filters (for Internal/External Filter Holder)

Sample Collection Cups

5243A	Deep Cup, Small (to bypass a stage, obviating impaction)
5242A	Malvern Glass Disc Cup, Small (for Malvern Panalytical Morphologi system)
5243	Exhaust Cup, Small (to bypass downstream stages of impactor)
5241	Gravimetric Cup Small (for APSD determinations based on weight)
5241A	Pack of 100 Filters for Small and Large Gravimetric Cup
5244	Gravimetric Cup Large (for APSD determinations based on weight)

Accessories

Cat. No.	Description
5222	NGI Collection Cup Rack
5205	NGI Carrying/Wash Rack
5265	Set of 2 Silicone Rubber Rinsing Caps for NGI Induction Port
5266	Set of 2 Silicone Rubber Rinsing Caps for NGI Preseparator
5227	Set of 2 Stainless Steel Rinsing Caps for NGI Induction Port
5228	Set of 2 Stainless Steel Rinsing Caps for NGI Preseparator
5232	Set of 2 Silicone Rubber Stoppers for NGI I.P./Preseparator
5224	Storage Cabinet for Impactor Collection Trays

NGI Cooler™

5009	NGI Cooler
5011	NGI Cooler Qualification Documentation
5012	NGI Cooler Qualification Tools
5013	Re-calibration of NGI Cooler Qualification Tools

Spare Parts

5208	Collection Cup Tray
5209	Set of 8 Collection Cups (2 Large, 6 Small)
5245	Welded Cup Tray Manifold
5211	Set of 18 Seals for the Next Generation Impactor
5246	Set of 10 Seals for the NGI Preseparator
5247	Set of 10 Seals for the NGI Internal Filter Holder
5248	Set of 10 Seals for the NGI External Filter Holder
5249	NGI Outlet Diameter Reducing Adapter



Andersen Cascade Impactor (ACI)

Well-established and readily accepted by the regulatory authorities, the ACI has been used for the APSD characterisation of OINDPs for over 30 years.

- Meets and exceeds all Ph.Eur. and USP specifications
- Low flow resistance at high flow rates when Stages 6 & 7 are removed
- 60 and 90 L/min Conversion Kits available for high flow rate testing, whilst retaining the 28.3 L/min cut-off diameters
- Electrically conductive; unaffected by static
- Reduced stack option for work with nasal aerosols and sprays

ACI: Key Features



Each Collection Plate contains the batch number for traceability



ACI with Induction Port



Available in a range of construction materials to ensure durability against different drug recovery solvents



Leak-free inter-stage sealing



A Quick-Release Connector is supplied as standard



A vertical planar layout with a small unit footprint



ACI: Materials of Construction

316 Stainless Steel

Superior corrosion resistance and durability to extend impactor life.

Titanium

Lightweight handling, superior corrosion resistance.

Aluminium

Lightweight, lower cost, where corrosion resistance is not an issue.



TOP TIP

When used at calibration flow rates, cascade impactors can be operated at different angles, which may be useful when testing device performance at different positions.

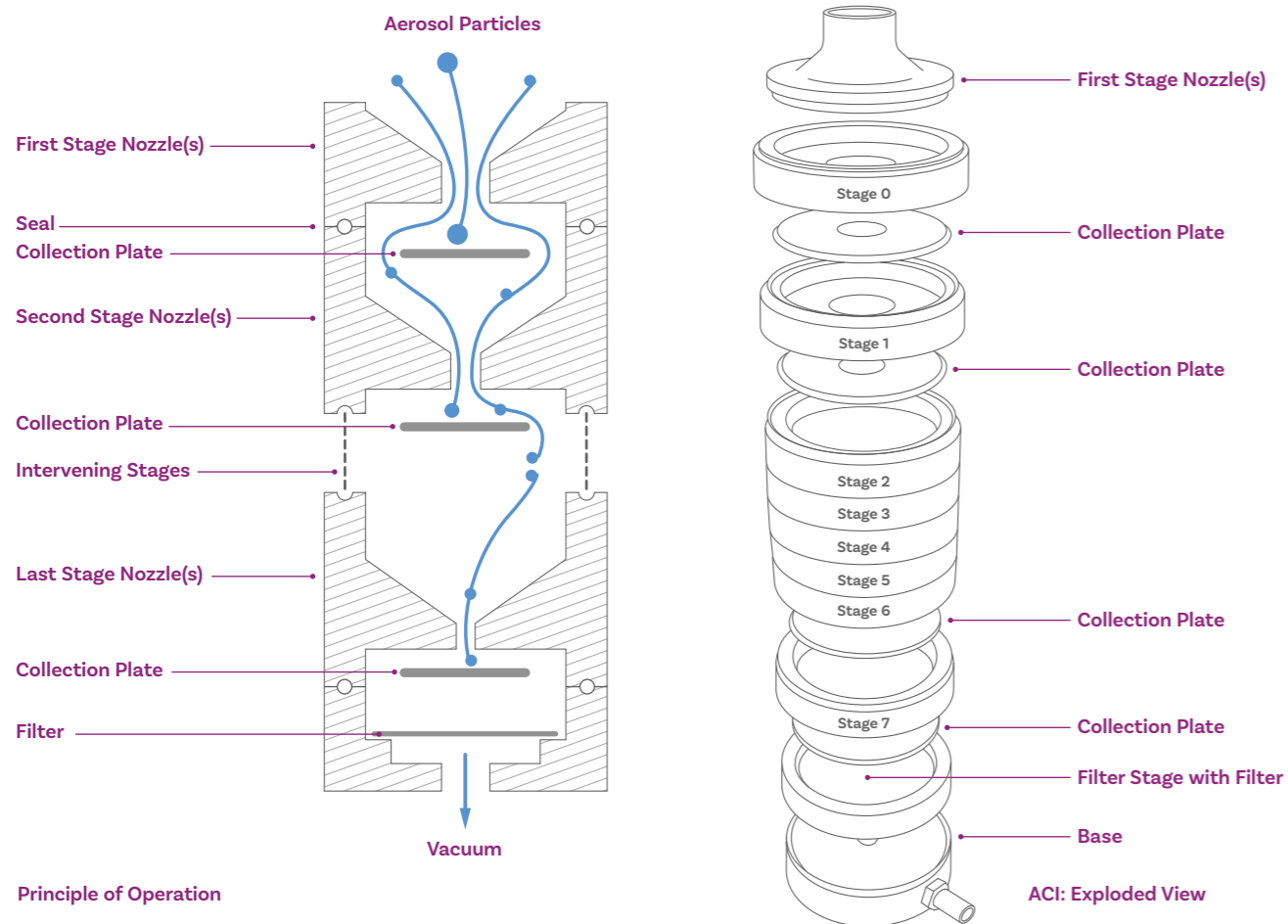

Principle of Operation

ACI: Exploded View

Unlike the NGI, the stages of the ACI are arranged vertically. The aerosol flow passes first through the stage at the top of the impactor, through to the last stage and a final filter at the bottom of the impactor arrangement.

ACI: Modified Configurations

The standard ACI is designed for use at 28.3 L/min. In some cases (particularly with low resistance DPIs), it is necessary to operate at flow rates greater than 28.3 L/min, if a pressure drop over the inhaler of 4 kPa is to be achieved. However, it is important to consider the

change in cut-points that would occur for each stage with any change to the flow rate. We offer two modified configurations of the ACI for operation at calibrated flow rates of 60 and 90 L/min to help address this.

28.3 L/min Version			60 L/min Version			90 L/min Version		
Stages	Plates	ECD*	Stages	Plates	ECD*	Stages	Plates	ECD*
0	0	9.0	-1	0	8.6	-2A	0	8.0
1	0	5.8	-0	0	6.5	-1A	0	6.5
2	x	4.7	1	0	4.4	-0	0	5.2
3	x	3.3	2	x	3.2	1	0	3.5
4	x	2.1	3	x	1.9	2	x	2.6
5	x	1.1	4	x	1.2	3	x	1.7
6	x	0.7	5	x	0.6	4	x	1.0
7	x	0.4	6	x	0.3	5	x	0.2
F		0.0	F		0.0	F		0.0

o = with hole
x = without a hole
* Effective Cut-Off Diameter

ACI: Component Parts

A number of supporting component parts are required in addition to the ACI itself:



USP Induction Port
Provides an airtight seal achieved between the ACI inlet and the mouthpiece adapter.



ACI Preseparator
Designed to collect the large mass of non-inhalable powder boluses emitted from powder-based inhalers prior to their entry into the impactor, the ACI Preseparator is ideal for DPI testing applications. Preseparators are available for testing at 28.3, 60 and 90 L/min.

ACI: Accessories



ACI Quick Clamp
Constructed from stainless steel, the ACI Quick Clamp enables quick and efficient adjustment of the ACI plate stack.



ACI Collection Plate Rack
For the convenient storage of the ACI collection plates, protecting the critical collection surfaces from inadvertent scratches and dents when not in use.

ACI: Accessories



ACI Carrying/Wash Rack

Constructed from heavy duty polypropylene and fitted with neoprene cushions, the ACI Carrying/Wash Rack is ideal for transporting the ACI system components around the laboratory and storing them, protecting the critical surfaces from damage and scratches. The rack is also designed to hold the components in place when used with our Impactor Cleaning System.

Rinsing Caps

Silicone Rubber Rinsing Caps are available for capping off the open ends of the ACI Induction Port during manual and automated drug recovery.

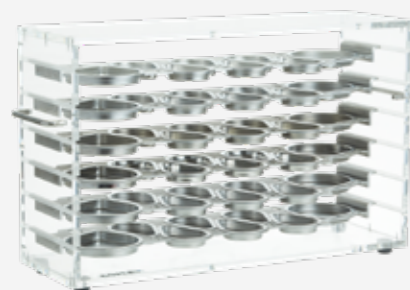
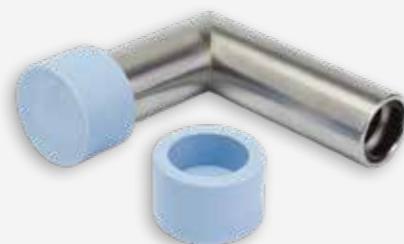

Storage Cabinet for Impactor Collection Trays

Accommodates up to six NGI Collection Cup Trays (NGI Collection Cup Trays not included).

TOP TIP

All ACIs supplied by Copley are machined to the same precision tolerances in order to guarantee reproducibility between impactors. Each ACI is supplied with a full stage mensuration report (system suitability).

ACI: Technical Specifications

Flow Rate Range	28.3 L/Min Modified configurations: Conversion kits for 60 L/Min and 90 L/Min available
Particle Size Range	0.4 - 9.0 microns (28.3 L/Min) 0.3 - 8.6 microns (60 L/Min) 0.2 - 8.0 microns (90 L/Min)
Number of Stages	8
Operation Method	Impaction
Inter-Stage Losses	Low to High (depending on product)
Method of Drug Assay	Chemical analysis - HPLC - UPLC - IR
Material(s) of Construction	Aluminium, 316 Stainless Steel or Titanium

Andersen Cascade Impactor (ACI)

Impactors

Cat. No.	Description
8301	28.3 L/Min Andersen Cascade Impactor*
8301-60	60 L/Min Andersen Cascade Impactor*
8301-90	90 L/Min Andersen Cascade Impactor*

Conversion Kits for the standard 28.3 L/min ACI

8318	Conversion Kit for 60 L/min operation*
8319	Conversion Kit for 90 L/min operation*

Component Parts

Induction Ports

8501	USP Induction Port*
8510	USP Induction Port (One-piece 316 Stainless Steel)
5239	FRS Flow Meter Adapter
5238	DFM Flow Meter Adapter

Preseparators for testing DPIs

8401	28.3 L/min Preseparator*
8420	60 L/min Preseparator*
8420-90	90 L/min Preseparator*

Accessories

Cat. No.	Description
5212	'Quick Clamp' for Andersen Cascade Impactor
5441	ACI Collection Plate Rack
5401	ACI Carrying/Wash Rack
5224	Storage Cabinet for Impactor Collection Trays

Accessories

Rinsing Caps

8504	Set of 2 Silicone Rubber Rinsing Caps for ACI Induction Port
-------------	--------------------------------------------------------------

Spare Parts

8307	Complete Set of 13 ACI Silicone Rubber O-Rings
8314	Set of 8 Stainless Steel Collection Plates (28.3 L/min)
8314-60	Set of 8 Stainless Steel Collection Plates (60 L/min)
8314-90	Set of 8 Stainless Steel Collection Plates (90 L/min)
8316	Box of 100 Glass Fibre Filters
8306	Set of 6 O-Rings for Spring Clamp
8308	Set of 3 Spring Clamps
8309	Set of 3 PVC End Caps for Spring Clamps
8403	Set of 4 O-Rings for Preseparator
8395	ACI Carrying Case
8351	Inlet Cone*
8352	Stage -2A*
8353	Stage -1A (for 90 L/min operation)*
8354	Stage -1 (for 60 L/min operation)*
8355	Stage -0*
8356	Stage 0*
8357	Stage 1*
8358	Stage 2*
8359	Stage 3*
8360	Stage 4*
8361	Stage 5*
8362	Stage 6*
8363	Stage 7*
8364	Stage F (Filter)*
8365	Base (including Hose Fitting)*

*Please specify Aluminium (A), 316 Stainless Steel (S) or Titanium (T) when placing your order.



Multi-Stage Liquid Impinger (MSLI)

A traditional apparatus for routine testing and research applications in industry and academia, the MSLI comprises four impaction stages and a final filter stage. Whilst it does not offer the number of stages of the ACI or NGI, it has virtually no inter-stage losses.

Also, unlike the ACI and NGI, the collection stages of the MSLI are kept moist, which eliminates the problem of particle bounce associated with conventional impactors.



Ph.Eur. Chapter 2.9.18 compliant for MDIs and DPIs



Eliminates particle bounce and re-entrainment problems



Choice of construction materials to suit all budgets and needs



Quick and easy to mensurate



Virtually no inter-stage losses

MSLI: Key Features



A vertical planar layout with a small unit footprint



PTFE seals as standard for leak-free testing



Bungs for easy solvent dispensing and sample collection access



A Quick-Release Connector is supplied as standard

MSLI with Induction Port



MSLI: Materials of Construction

316 Stainless Steel
Superior corrosion resistance and durability to extend impactor life.

Titanium
Lightweight handling, superior corrosion resistance.

Aluminium
Lightweight, lower cost, where corrosion resistance is not an issue.



TOP TIP

A stage mensuration certificate and leak test certificate are included with each MSLI as standard. During the mensuration, the sintered glass impingement stages are positioned using calibrated gauge blocks to ensure that the correct jet-to-plate distance is maintained.

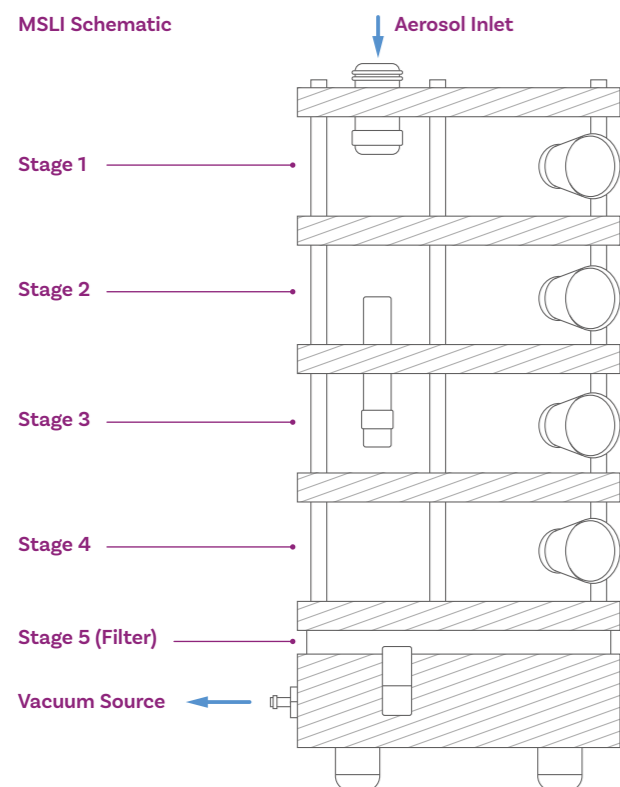

The aerosol stream is drawn into the top of the MSLI, passing first through Stage 1 which acts as a preseparator. Particles with sufficient inertia will impact on the moist surface of the sintered glass disc. Those with insufficient inertia will pass through to Stage 2. The same process of impaction and particle selection takes place until the final filter stage (Stage 5), which captures any remaining fine particles.

The cut-off diameters for the relevant stages at a volumetric flow rate of 60 L/min are shown in the table below.

MSLI Cut-Off Diameters

	60	L/Min
Stage 1	13.0	microns
Stage 2	6.8	microns
Stage 3	3.1	microns
Stage 4	1.7	microns
Stage 5 (Filter)	< 1.7	microns

MSLI: Technical Specifications

Flow Rate Range	Between 30 and 100 L/min
Particle Size Range	1.7 - 13.0 microns (dependent on flow rate)
No. of Stages	4
Operation Method	Impingement
Inter-Stage Losses	Zero
Method of Drug Assay	Chemical Analysis - HPLC - UPLC - IR
Material(s) of Construction	Aluminium, 316 Stainless Steel or Titanium

Multi-Stage Liquid Impinger (MSLI)

Cat. No.	Description
8801	Multi-Stage Liquid Impinger (MSLI)*
8501	USP Induction Port*
8510	USP Induction Port (One-piece 316 Stainless Steel)
5239	FRS Flow Meter Adapter
5238	DFM Flow Meter Adapter

Options

8851	Torque Adjuster for MSLI
-------------	--------------------------

Spare Parts

8805	Set of 3 O-Rings
8807	Set of 8 Inter-Stage PTFE Gaskets (Code M)
8814	Filter Support Plate (Code S)
8834	Pack of 10 Silicone Rubber Stoppers
8839	Pack of 100 Glass Fibre Filters
8840	Ground Glass Cylinder (Code E)
8844	Set of 4 Sintered Glass Discs (Code D)

* Please specify Aluminium (A), 316 Stainless Steel (S) or Titanium (T) when placing your order.





Glass Twin Impinger (GTI)

Retained as Apparatus A in Ph.Eur. 2.9.18 due to its value as a simple and inexpensive routine quality control tool, the two-stage GTI is ideal for use where batch-to-batch variability in FPD is required and a coarser test may be acceptable.

Its usage is typically restricted to the assessment of nebulisers, MDIs, nasal sprays and DPIs where it can be demonstrated that a flow rate of 60 (+/-5) L/min is suitable.



Ph.Eur. 2.9.18 compliant (Apparatus A)



Regular mensuration is not required



No inter-stage losses



Ideal for routine quality control applications

GTI Key Features:

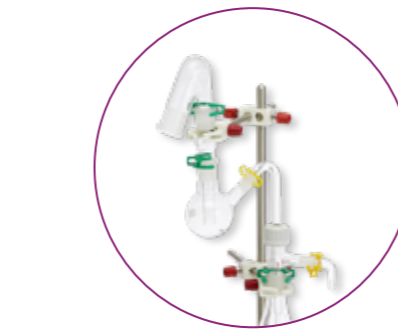

A special modification for the measurement of the particle size of nasal sprays according to the Aiache and Beyssac method is also available as an option.

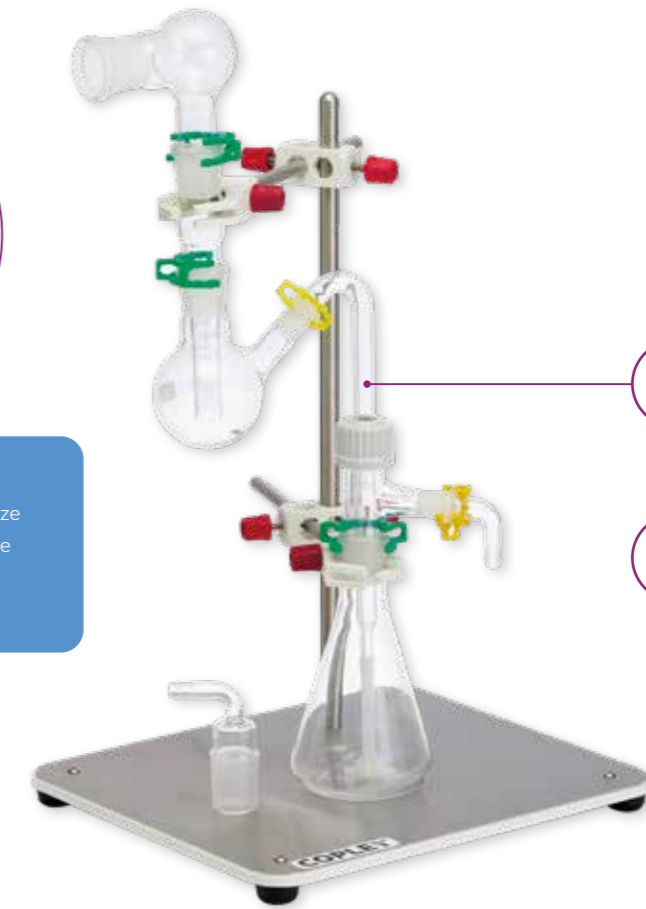

Corrosion resistant



Small unit footprint

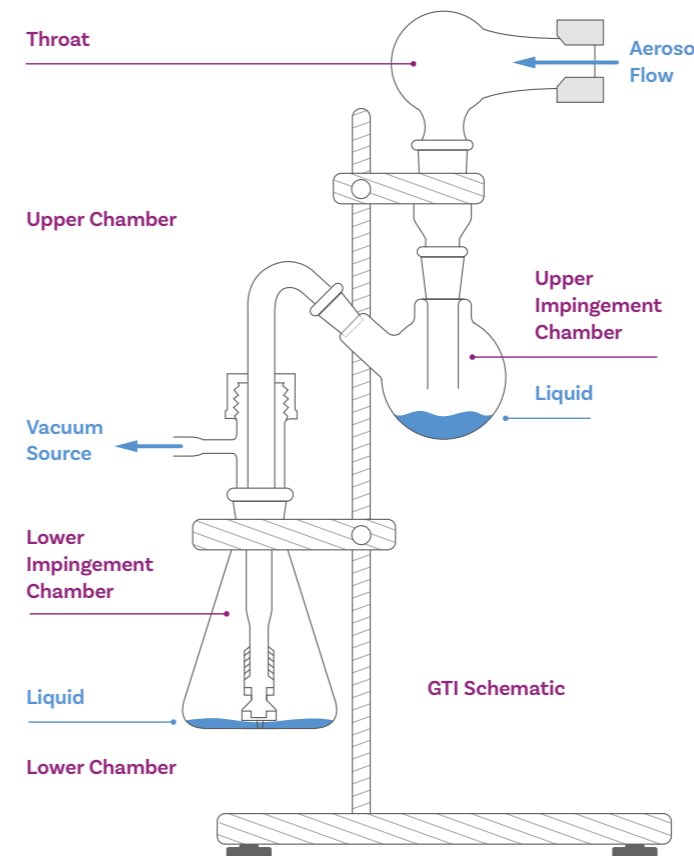

The GTI operates on the principle of liquid impingement to divide the dose emitted from the inhaler into respirable and non-respirable portions.

Prior to testing, 7 mL of solvent is typically dispensed into the upper impingement chamber and 30 mL to the lower impingement chamber.

The upper impingement chamber (stage 1) is designed such that at a flow rate of 60 L/min through the impinger, the particle cut-off is 6.4 microns. Particles smaller than 6.4 microns pass into the lower impingement chamber (stage 2).

After the test is complete, the active drug collected in the lower impingement chamber is assayed and expressed as a respirable fraction (or percentage) of the delivered dose.

GTI: Technical Specifications

Flow Rate Range	60 L/Min
Particle Size Range	6.4 microns only
Number of Stages	1
Operation Method	Impingement
Inter-Stage Losses	Zero
Method of Drug Assay	Chemical Analysis - HPLC - UPLC - IR
Material(s) of Construction	Glass

Glass Twin Impinger (GTI)

Cat. No. Description

- 8901** Glass Twin Impinger
- 8999** Modification for Nasal Sprays (acc. to Aiache & Beysac)
- 8920** FRS Flow Meter Adapter for GTI/FP Ind Port





Spare Parts

- 8906** Coupling Tube (Ph.Eur. Code E)
- 8907** Screwthread Side-Arm Adapter (Ph.Eur. Code F)
- 8912** Lower Jet Assembly (Ph.Eur. Code G)
- 8908** Lower Impingement Chamber (Ph.Eur. Code H)
- 8909** Throat Flow Meter Adapter (Ph.Eur. Code I)
- 8910** Vacuum Pump Adapter (Ph.Eur. Code J)
- 8913** Set of 2 Conical Joint Clips (Yellow)
- 8914** Set of 4 Conical Joint Clips (Green)
- 8916** Spare Set of Glassware (incl. clips and Lower Jet Assembly)









Spare Parts

- 8903** Throat (Ph.Eur. Code B)
- 8904** Neck (Ph.Eur. Code C)
- 8905** Upper Impingement Chamber (Ph.Eur. Code D)

Technical Specifications: Comparison Summary

				
	NGI	ACI	MSLI	GTI
Flow Rate Range	15 – 100 L/min	28.3 L/min 60 L/min 90 L/min	30 – 100 L/min	60 L/min
Particle Size Range	0.24 – 11.7 microns	0.4 – 9.0 microns	1.7 – 13.0 microns	6.4 microns
Number of Stages	7	8	4	1
Operation Method	Impaction	Impaction	Impingement	Impingement
Method of Drug Assay	Chemical Analysis (HPLC, UPLC, IR)			

Choose your Impactor

Device Type					Pharmacopoeia
MDI 	Y	Y	Y	Y	Ph. Eur./EMA
	Y	Y	N	N	USP/FDA
	Y	Y	N	Y	ChP
	Y	Y	Y	N	JP
MDI with a Spacer/ Valved Holding Chamber (VHC) 	Y	Y	Y	Y	Ph. Eur./EMA
	Y	Y	N	N	USP/FDA
	Y	Y	N	Y	ChP
	Y	Y	N	N	JP
DPI 	Y	Y	Y	Y	Ph. Eur./EMA
	Y	Y	Y	N	USP/FDA
	Y	Y	N	Y	ChP
	Y	Y	Y	N	JP
Nebuliser 	Y	N	N	N	Ph. Eur./EMA
	Y	N	N	N	USP/FDA
	Y	N	N	N	ChP
SMI 	Y	N	N	N	JP
	Y	Y	N	N	Ph. Eur./EMA
	Y	Y	N	N	USP/FDA
	Y	Y	N	N	ChP
Nasal Products 	Y	Y	N	N	JP
	Y	Y	N	N	Ph. Eur./EMA
	Y	Y	N	N	USP/FDA

Aerodynamic Particle Size Distribution

Metered Dose Inhalers (MDIs)





The APSD testing of MDIs is typically performed at a flow rate of 28.3 L/min when using an ACI or 30 L/min when using an NGI. For Breath Actuated MDIs (BAIs) a Breath Actuation Controller may also be used to generate a time delay.

There is no requirement for a preseparator in MDI measurement. Plate and/or cup coating may be used to prevent particle bounce and re-entrainment, but is generally not required if the formulation includes a surfactant. Multiple doses are typically required to

achieve analytical sensitivity.

For further information on the APSD testing of MDIs with a Spacer or Valved Holding Chamber (VHC), see page 111.

Regulations and Guidelines

 NGI	Organisation	Chapter/Guidance
	Ph. Eur. / EMA	2.9.18 App E
	USP / FDA	<601> App 6
	ChP	<0951> App 3
 ACI	Organisation	Chapter/Guidance
	Ph. Eur. / EMA	2.9.18 App D
	USP / FDA	<601> App 1
	ChP	<0951> App 2
 MSLI	Organisation	Chapter/Guidance
	Ph. Eur. / EMA	2.9.18 App C
	USP / FDA	<601> App 1
	ChP	-
 GTI	Organisation	Chapter/Guidance
	Ph. Eur. / EMA	2.9.18 App A
	USP / FDA	-
	ChP	<0951>/App 1
 GTI	Organisation	Chapter/Guidance
	Ph. Eur. / EMA	2.9.18 App A
	USP / FDA	-
	ChP	<0951>/App 1

APSD of MDIs Manual Test System Set-Up

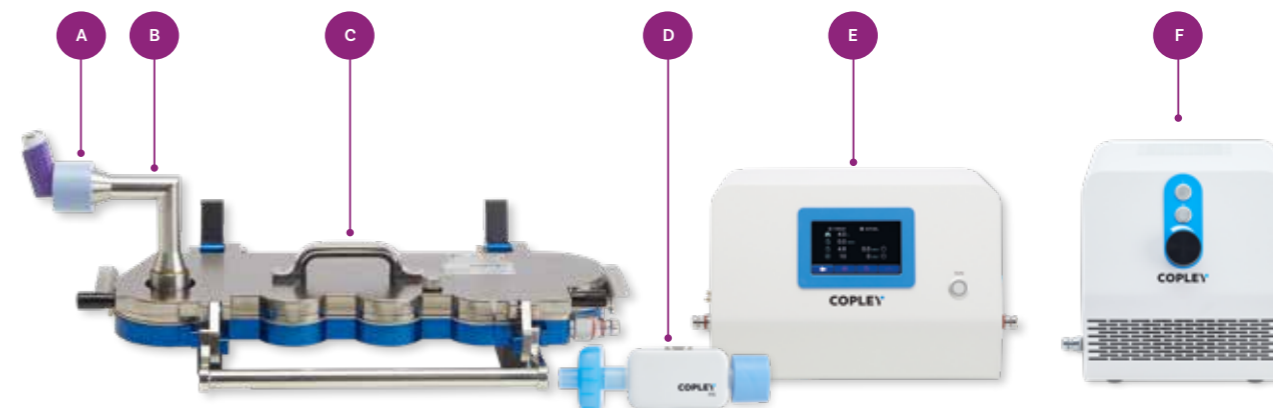

- A** Mouthpiece Adapter
- B** Induction Port
- C** Next Generation Impactor NGI
- D** Flow Rate Sensor FRS
- E** Breath Actuation Controller BAC
- F** Vacuum Pump

Alternative Impactors/Impingers

Andersen Cascade Impactor ACI

Multi-Stage Liquid Impinger MSLI

Glass Twin Impinger GTI

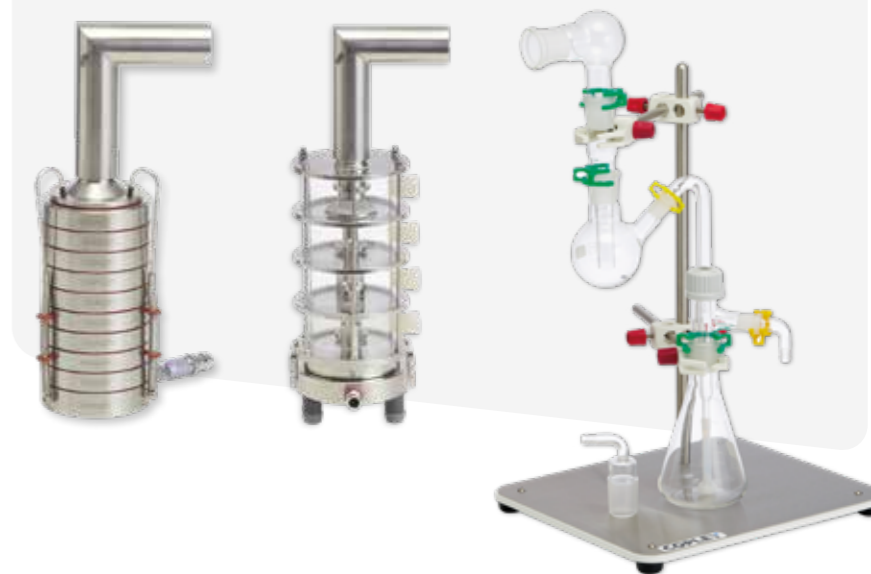

Considering the effects of environmental variability?

Our environmental control solutions are designed to help improve the accuracy, sensitivity and reproducibility of test data. Learn more on page 196.

Related Accessories

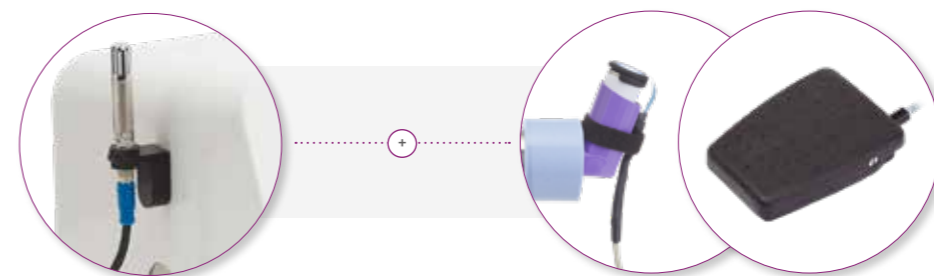

Temperature and Relative Humidity Sensor

Ideal for measuring environmental test conditions. See page 179.

MDI Actuation Sensor/Footswitch

Suitable for most commercially available MDI canisters, the MDI Actuation Sensor connects directly to the Breath Actuation Controller BAC 100i to ensure precise synchronisation of MDI actuation. Alternatively, a Footswitch can be attached to trigger actuation. See page 179.

APSD of MDIs: Manual Test System Component Parts

Next Generation Impactor NGI

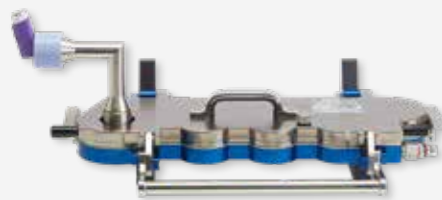

The recommended test set-up is with an NGI, but an ACI may also be used. Impactors with 7 or 8 stages are preferred by regulators, as they provide good APSD resolution. However, for some established methods the MSLI or GTI may be acceptable.



In addition to the above, the following is needed to complete a fully-operational test set-up for APSD measurement of MDIs:

Vacuum Pump

Designed for optimal operation at the flow rates required for MDI testing, the Low Capacity Pump LCP7 represents the latest in high performance, low maintenance, vacuum pump technology. Our Vacuum Pump range is specifically designed for use in the testing of OINDPs in accordance with pharmacopoeial requirements.

See page 188 for further information about our Vacuum Pump range.



Required for:



Breath Actuation Controller BAC



Ensuring that the volume of air sampled does not exceed the pharmacopoeial specifications, the Breath Actuation Controller BAC 100i contains an electronically operated, timer-controlled two-way solenoid valve and is positioned between the impactor and Vacuum Pump to control air flow through the inhaler.

See page 172 for further information about our Flow Controller range.

Recommended for:



TOP TIP

The BAC 100i can also be used for the testing of Breath-Actuated (or Breath-Operated) MDIs. In this case, the BAC 100i is used to initiate the flow, simultaneously triggering the breath-actuated inhaler.

Flow Rate Sensor FRS



Used for establishing accurate and consistent inlet flow rate during testing, the Flow Rate Sensor FRS measures flow rates to the accuracy specified by the pharmacopoeias. See page 184 for further information about flow rate measurement.

Required for:



Inhaler Testing Workstation™ ITW

Designed to keep the apparatus organised during testing and improve workflow efficiency, the Inhaler Testing Workstation ITW holds the cascade impactor and flow meter in position throughout the testing process.

See page 204 for further information.

Recommended for:



Mouthpiece Adapter



Moulded from high quality silicone rubber, our Mouthpiece Adapters guarantee an airtight seal between the inhaler under test and the test apparatus. For a list of available Mouthpiece Adapters see page 214.

Custom Mouthpiece Adapters are available upon request.

Required for:



Qualification

GMP regulations require that

- The test methods used to monitor pharmaceuticals must meet proper standards of accuracy and reliability
- Companies should establish procedures to ensure the fitness for use of instruments that generate data supporting product testing

Copley provides a range of qualification documentation, services and tools to meet these requirements.

See page 324 for further information.



APSD of MDIs Automated Test System Set-Up

The Vertus® III automated shake, fire and shot waste range is made up of integrated turn-key solutions for precise, controlled and reproducible MDI testing.

Compatible with most MDIs, the Vertus III systems offer analysts complete control over:

- **The speed, angle and duration of shaking, ahead of actuation**
- **Firing force and the speed of application and release of that force**
- **The time delay between the end of shaking and device actuation**

- ✓ Improve inhaler testing accuracy and reproducibility
- ✓ Increase productivity and reduce hassle
- ✓ Replicate test methods across different sites with ease
- ✓ Reduce handling errors and costly out-of-specification results

Vertus III & Vertus III+

Offering high productivity, walkaway MDI testing, the Vertus III and Vertus III+ can be used for APSD sampling directly with an NGI, ACI or GTI. The Vertus III+ also offers optional shot weight collection.



Replaces the need for:

Vacuum Pump



Breath Actuation Controller



Inhaler Testing Workstation™



See page 292 for further information about the Vertus III range.

Connected Data Management



Data generated using these equipment configurations may be processed and reported through Inhalytix®, Copley's validated data management platform.

By structuring test methods, automating metric calculation and linking results to user attribution and equipment metadata, Inhalytix+ reduces manual data handling and strengthens data integrity. Where compatible ancillary or automation tools are connected, selected operational parameters can be captured automatically alongside analytical results, supporting traceability and regulatory-aligned reporting.

See page 218 to learn how Inhalytix+ can improve workflow efficiency and strengthen data integrity for APSD measurement workflows.

Automation Tools

- ✓ Improve efficiency
- ✓ Reduce variability
- ✓ Eliminate handling errors
- ✓ Increase testing capacity



Gentle Rocker™ GR 200i

Promotes easy and fully repeatable dissolution of active drug present on NGI Collection Cup and ACI Collection Plate surfaces prior to analysis. See page 310.

Recommended for:



Sample Recovery System SRS 100i

Provides controlled recovery from impactor stages, preseparators and induction ports to support consistent sample preparation prior to analysis. See page 302.

Recommended for:



Sample Preparation Unit SPU 200i

Simplifies and standardises drug recovery from induction ports and preseparators. See page 314.

Recommended for:



Impactor Cleaning System

Standardises cleaning and drying procedures to help ensure the NGI and ACI remain in optimum condition throughout their life. See page 320.

Recommended for:



Related Applications

We also offer a range of equipment for additional MDI testing application support:



For better *in vitro-in vivo* correlation (IVIVC) testing
See page 226

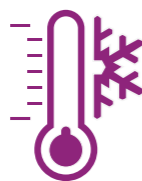

For cold Freon® effect testing
See page 261



For USP product-specific monographs
See page 274

Training, Servicing & Support

We offer a comprehensive range of services from bespoke product design to installation, expert training and technical support, optimising all aspects of pharmaceutical testing from start to finish.



Training
See page 335



Servicing
See page 330



Support
334



Design
See page 335

Aerodynamic Particle Size Distribution

MDIs with a Spacers/VHC

Due to the potential opportunity for particle expansion, impaction and deposition within the chamber of add-on devices such as spacers or VHCs, the APSD characteristics may be substantially altered from what is emitted when the MDI is used alone. This potential for change must be appropriately assessed.

Regulations and Guidelines

	Organisation	Chapter/Guidance
 NGI	Ph. Eur. / EMA	-
	USP / FDA	<1602> App 6
	ChP	-
	JP	-
 ACI	Organisation	Chapter/Guidance
	Ph. Eur. / EMA	-
	USP / FDA	<1602> App 1
	ChP	-
	JP	-

In Section 3 of USP Chapter <1602> Spacers and Valved Holding Chambers used with Inhalation Aerosols, two tests are specified relating to the APSD characterisation of add-on devices used with the MDIs:

Test 3.1

Designed to measure the APSD from the spacer/VHC when used under optimal conditions, that is, with no delay following actuation of the inhaler. Direct comparisons can then be made between the APSD produced by the MDI both with and without the add-on device.

Test 3.2

For testing VHCs only and designed to measure the APSD from the VHC when used under “worst case” conditions, i.e. with a delay of 2 or more seconds between inhaler actuation and patient inspiration.

The delay can be simulated by placing a timer controlled two-way solenoid valve such as the Breath Actuation Controller BAC 100i between the impactor and the pump.

APSD of MDIs with a Spacer/VHC Test System Set-Up

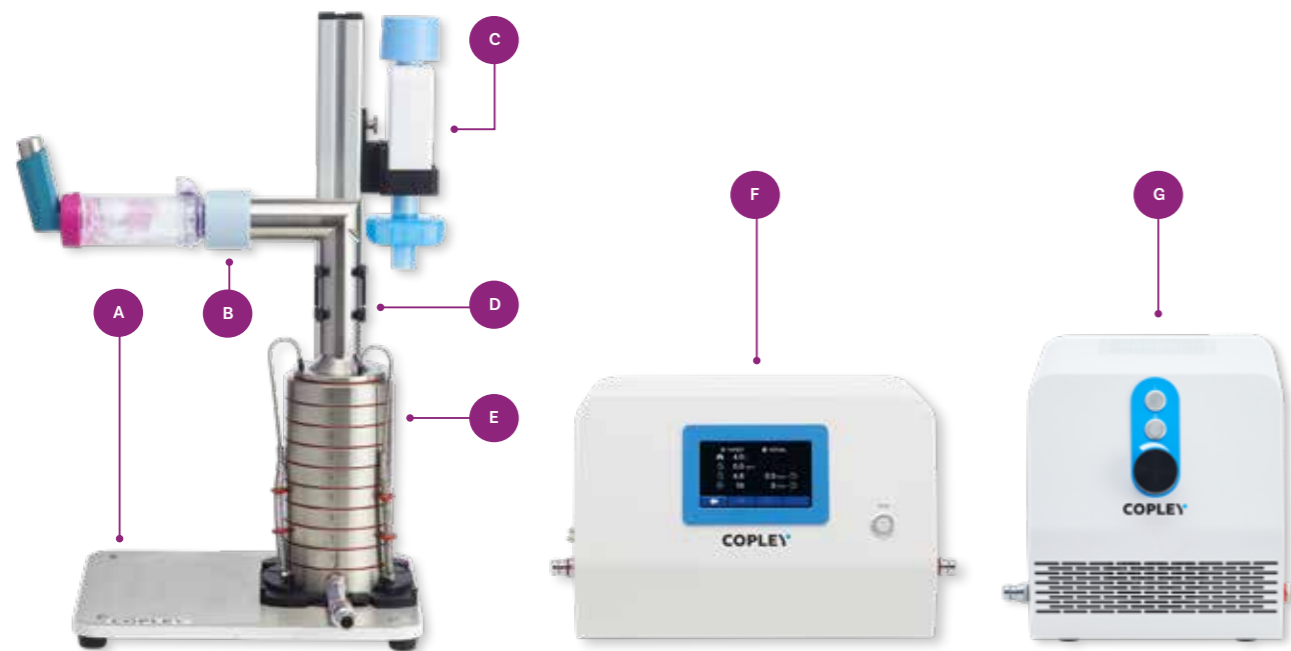

- A** Inhaler Testing Workstation™ ITW
- B** Mouthpiece Adapter
- C** Flow Rate Sensor FRS
- D** Induction Port
- E** Andersen Cascade Impactor ACI
- F** Breath Actuation Controller BAC
- G** Vacuum Pump

Considering the effects of environmental variability?

Our environmental control solutions are designed to help improve the accuracy, sensitivity and reproducibility of test data.

Learn more on page 196.



Alternative Impactors



Next Generation Impactor NGI

Related Accessories

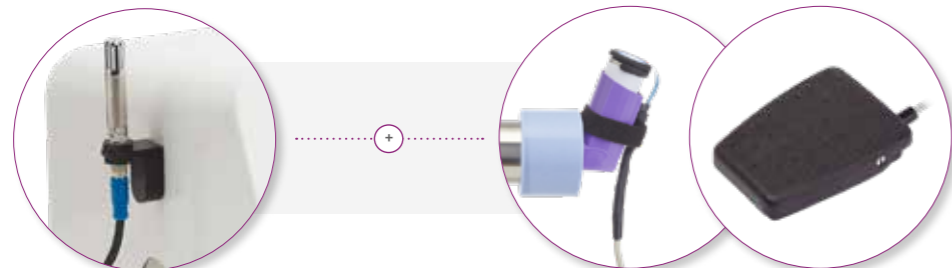

Temperature and Relative Humidity Sensor

Ideal for measuring environmental test conditions. See page 179.

MDI Actuation Sensor/Footswitch

Suitable for most commercially available MDI canisters, the MDI Actuation Sensor connects directly to the Breath Actuation Controller BAC 100i to ensure precise synchronisation of MDI actuation. Alternatively, a Footswitch can be attached to trigger actuation. See page 179.

APSD of MDIs with a Spacer/VHC: Test System Component Parts



Andersen Cascade Impactor ACI

If the spacer/VHC is intended for adults, then the standard ACI or NGI should be used with a suitable vacuum pump capable of producing 28.3 or 30 L/min respectively. If the add-on device is intended for neonates, infants or small children, then only the NGI should be used as this can be used at the lower flow rate of 15 L/min.



In addition to the above, the following is needed to complete a fully-operational test set-up for the APSD measurement of MDIs with a spacer or VHC:

Vacuum Pump

Designed for optimal operation at the low flow rates required for MDI testing, the Low Capacity Pump LCP7 represents the latest in high performance, low maintenance, vacuum pump technology. Our Vacuum Pump range is specifically designed for use in the testing of OINDPs in accordance with pharmacopoeial requirements.

See page 188 for further information about our Vacuum Pump range.

Required for:



Breath Actuation Controller BAC

Ensuring that the volume of air sampled does not exceed the pharmacopoeial specifications, the Breath Actuation Controller BAC 100i contains an electronically operated, timer-controlled two-way solenoid valve and is positioned between the impactor and Vacuum Pump to control air flow supply to the inhaler.

See page 172 for further information about our Flow Controller range.

Recommended for:





Flow Rate Sensor FRS

Used for establishing accurate and consistent inlet flow rate during testing, the Flow Rate Sensor FRS measures flow rates to the accuracy specified by the pharmacopoeias.

See page 184 for further information about flow rate measurement.

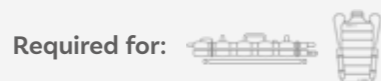

Inhaler Testing Workstation™ ITW

Designed to keep the apparatus organised during testing and improve workflow efficiency, the Inhaler Testing Workstation ITW keeps the cascade impactor and flow meter in position throughout the testing process.

See page 204 for further information.

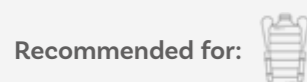

Mouthpiece Adapter

Moulded from high quality silicone rubber, our Mouthpiece Adapters guarantee an airtight seal between the inhaler/add-on device combination under test and the test apparatus. For a list of available Mouthpiece Adapters see page 214.

Custom Mouthpiece Adapters are available upon request.

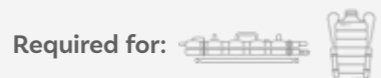

Qualification

GMP regulations require that

- The test methods used to monitor pharmaceuticals must meet proper standards of accuracy and reliability
- Companies should establish procedures to ensure the fitness for use of instruments that generate data supporting product testing

Copley provides a range of qualification documentation, services and tools to meet these requirements.

See page 324 for further information.



Connected Data Management



Data generated using these equipment configurations may be processed and reported through Inhalytix[®]+, Copley's validated data management platform.

By structuring test methods, automating metric calculation and linking results to user attribution and equipment metadata, Inhalytix+ reduces manual data handling and strengthens data integrity. Where compatible ancillary or automation tools are connected, selected operational parameters can be captured automatically alongside analytical results, supporting traceability and regulatory-aligned reporting.

See page 218 to learn how Inhalytix+ can improve workflow efficiency and strengthen data integrity for APSD measurement workflows.

Automation Tools

- ✓ Improve efficiency
- ✓ Reduce variability
- ✓ Eliminate handling errors
- ✓ Increase testing capacity



Gentle Rocker™ GR 200i

Promotes easy and fully repeatable dissolution of active drug present on NGI Collection Cup and ACI Collection Plate surfaces prior to analysis. See page 310.



Sample Recovery System SRS 100i

Provides controlled recovery from impactor stages, preseparators and induction ports to support consistent sample preparation prior to analysis. See page 302.



Sample Preparation Unit SPU 200i

Simplifies and standardises drug recovery from induction ports and preseparators. See page 314.



Impactor Cleaning System

Standardises cleaning and drying procedures to help ensure the NGI and ACI remain in optimum condition throughout their life. See page 320.



Related Applications

We also offer a range of equipment for additional application testing support:



For facemask testing
See page 250

Training, Servicing & Support

We offer a comprehensive range of services from bespoke product design to installation, expert training and technical support, optimising all aspects of pharmaceutical testing from start to finish.



Training
See page 355



Servicing
See page 330



Support
See page 334



Design
See page 335



Aerodynamic Particle Size Distribution

Dry Powder Inhalers (DPIs)

The APSD measurement of DPIs is typically performed under the same conditions as DDU testing. However there are some differences.





A preseparator is typically interposed between the induction port and stage 0 of cascade impactor to capture the large, non-inhalable carrier particles, to prevent impactor over-loading.

As for delivered dose testing of DPIs, test flow rate is set on the basis of a 4 kPa pressure drop across the

device, to approximate the mean patient inhalation flow rate achieved during clinical use.

Cup-coating should be considered and validated as part of method development to reduce particle bounce and re-entrainment.

Regulations and Guidelines

	Organisation	Chapter/Guidance
 NGI	Ph. Eur. / EMA	2.9.18 App. E
	USP / FDA	601 App. 5
	ChP	<0951> App. 3
	JP	6.15.5 App 3
 ACI	Ph. Eur. / EMA	2.9.18 App. D
	USP / FDA	601 App. 2
	ChP	<0951> App. 2
	JP	6.15.5 App 2
 MSLI	Ph. Eur. / EMA	2.9.18 App. C
	USP / FDA	601 App. C
	ChP	-
	JP	6.15.5 App 1
 GTI	Ph. Eur. / EMA	2.9.18 App. A
	USP / FDA	-
	ChP	<0951> App. 1
	JP	-

APSD of DPIs Test System Set-Up

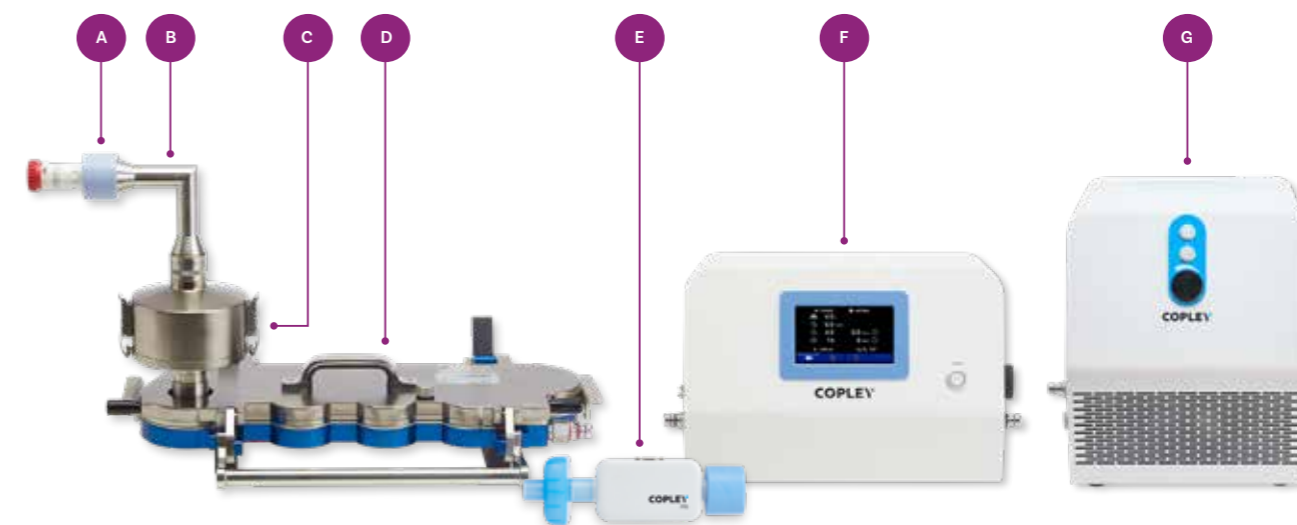

- A Mouthpiece Adapter
- B Induction Port
- C Preseparator
- D Next Generation Impactor NGI
- E Flow Rate Sensor FRS
- F Critical Flow Controller TPK
- G Vacuum Pump

Alternative Impactors/Impingers

Andersen Cascade Impactor ACI



Multi-Stage Liquid Impinger MSLI



Glass Twin Impinger GTI

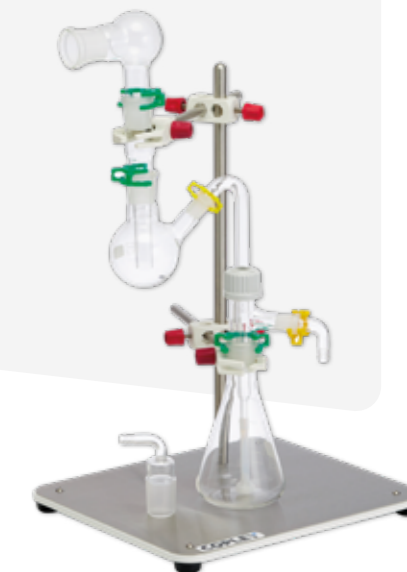

Considering the effects of environmental variability?

Our environmental control solutions are designed to help improve the accuracy, sensitivity and reproducibility of test data.

Learn more on page 196.

Related Accessories



Temperature and Relative Humidity Sensor

Ideal for measuring environmental test conditions. See page 183.



Footswitch

Connecting directly to the Critical Flow Controller TPK 100i, the Footswitch enables precise synchronisation of DPI actuation with the onset of flow. See page 183.

APSD of DPIs: Test System Component Parts

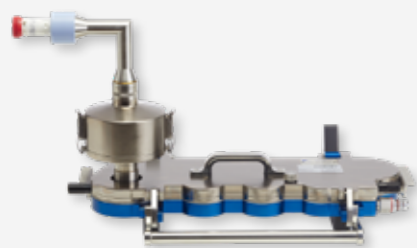

Next Generation Impactor NGI

The recommended test set-up is with an NGI, but an ACI may also be used. Impactors with 7 or 8 stages are preferred by the regulators, as they provide good APSD resolution. However, for some established methods the MSLI or GTI may be acceptable.



DON'T FORGET



Preseparator

For the collection of large mass, non-inhalable powder boluses typically emitted from a DPI, prior to entry into the impactor. Different preseparators are available for the NGI and ACI.

See pages 87 and 93 respectively.

Note: Preseparators are not required for APSD testing of DPIs using an MSLI or GTI.

Required for:

In addition to the above, the following is needed to complete a fully-operational test set-up for the APSD measurement of DPIs:

Vacuum Pump

Ideal for the higher, sonic flow rate testing requirements of DPIs, the High Capacity Pump HCP7 and Super Capacity Pump SCP7 represent the latest in high performance, low maintenance, vacuum pump technology. Our Vacuum Pump range is specifically designed for use in the testing of OINDPs in accordance with pharmacopoeial requirements.

See page 188 for further information about our Vacuum Pump range.

Required for:



TOP TIP

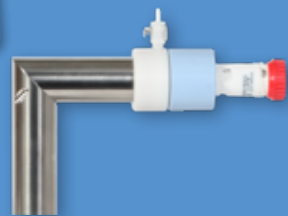

Induction Port P1 Measurement Adapter

Used together with the Critical Flow Controller, the Induction Port P1 Measurement Adapter can be placed between the inhaler and the NGI or USP Induction Port to measure the pressure drop (P1) over the inhaler under test in the absence of a DUSA for DPIs. Cat No: 8502.



Critical Flow Controller TPK

Simplify DPI test system set-up in accordance with pharmacopoeial recommendations with the Critical Flow Controller series. Positioned between the impactor and vacuum pump, the Critical Flow Controller TPK 100i ensures critical (sonic) flow conditions during testing. It measures and records all parameters required for testing and for controlling flow conditions.

See page 172 for further information about our Flow Controller range.

Required for:

Flow Rate Sensor FRS

Used for establishing accurate and consistent inlet flow rate during testing, the Flow Rate Sensor FRS measures flow rates to the accuracy specified by the pharmacopoeias.

See page 184 for further information about flow rate measurement.

Required for:



Inhaler Testing Workstation™ ITW

Designed to keep the apparatus organised during testing and improve workflow efficiency, the Inhaler Testing Workstation ITW keeps the cascade impactor and flow meter in position throughout the testing process.

See page 204 for further information.

Recommended for:

Mouthpiece Adapter

Moulded from high quality silicone rubber, our Mouthpiece Adapters guarantee an airtight seal between the inhaler under test and the test apparatus. For a list of available Mouthpiece Adapters see page 214.

Custom Mouthpiece Adapters are available upon request.

Required for:



Inhaler Support Accessory

Secures the inhaler to the Mouthpiece Adapter, ensuring a stable, airtight interface with the Induction Port.

See page 215.



Qualification

GMP regulations require that

- The test methods used to monitor pharmaceuticals must meet proper standards of accuracy and reliability
- Companies should establish procedures to ensure the fitness for use of instruments that generate data supporting product testing



Copley provides a range of qualification documentation, services and tools to meet these requirements.

See page 324 for further information.

Connected Data Management



Data generated using these equipment configurations may be processed and reported through Inhalytix+, Copley's validated data management platform.

By structuring test methods, automating metric calculation and linking results to user attribution and equipment metadata, Inhalytix+ reduces manual data handling and strengthens data integrity. Where compatible ancillary or automation tools are connected, selected operational parameters can be captured automatically alongside analytical results, supporting traceability and regulatory-aligned reporting.

See page 218 to learn how Inhalytix+ can improve workflow efficiency and strengthen data integrity for APSD measurement workflows.

Automation Tools



Improve efficiency



Reduce variability



Eliminate handling errors



Increase testing capacity

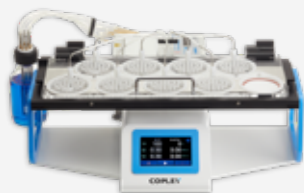

Impactor Coater™ IC 200i



Standardises impaction surface coating for both NGI Collection Cups and ACI Collection Plates. See page 308.

Recommended for:  



Gentle Rocker™ GR 200i

Promotes easy and fully repeatable dissolution of active drug present on NGI Collection Cup and ACI Collection Plate surfaces prior to analysis. See page 310.

Recommended for:  



Impactor Genie™ IG 200i

An innovative 2-in-1 solution combining the coating capabilities of the Impactor Coater IC 200i with the drug recovery features of the Gentle Rocker GR 200i. See page 312.

Recommended for:  



Sample Recovery System SRS 100i

Provides controlled recovery from impactor stages, preseparators and induction ports to support consistent sample preparation prior to analysis. See page 302.

Recommended for:   



Sample Preparation Unit SPU 200i

Simplifies and standardises drug recovery from the Induction Ports and Preseparators. See page 314.

Recommended for:   



Impactor Cleaning System

Standardises cleaning and drying procedures to help ensure the NGI and ACI remain in optimum condition throughout their life. See page 320.

Recommended for:  

Related Applications

We also offer a range of equipment for additional DPI testing application support:



For better *in vitro-in vivo* correlation (IVIVC) testing
See page 226



For USP product-specific monographs
See page 274

Training, Servicing & Support

We offer a comprehensive range of services from bespoke product design to installation, expert training and technical support, optimising all aspects of pharmaceutical testing from start to finish.



Training
See page 335



Servicing
See page 330

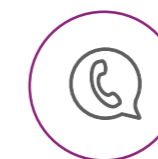

Support
See page 334



Design
See page 335



APSD of Nebulisers Test System Set-Up

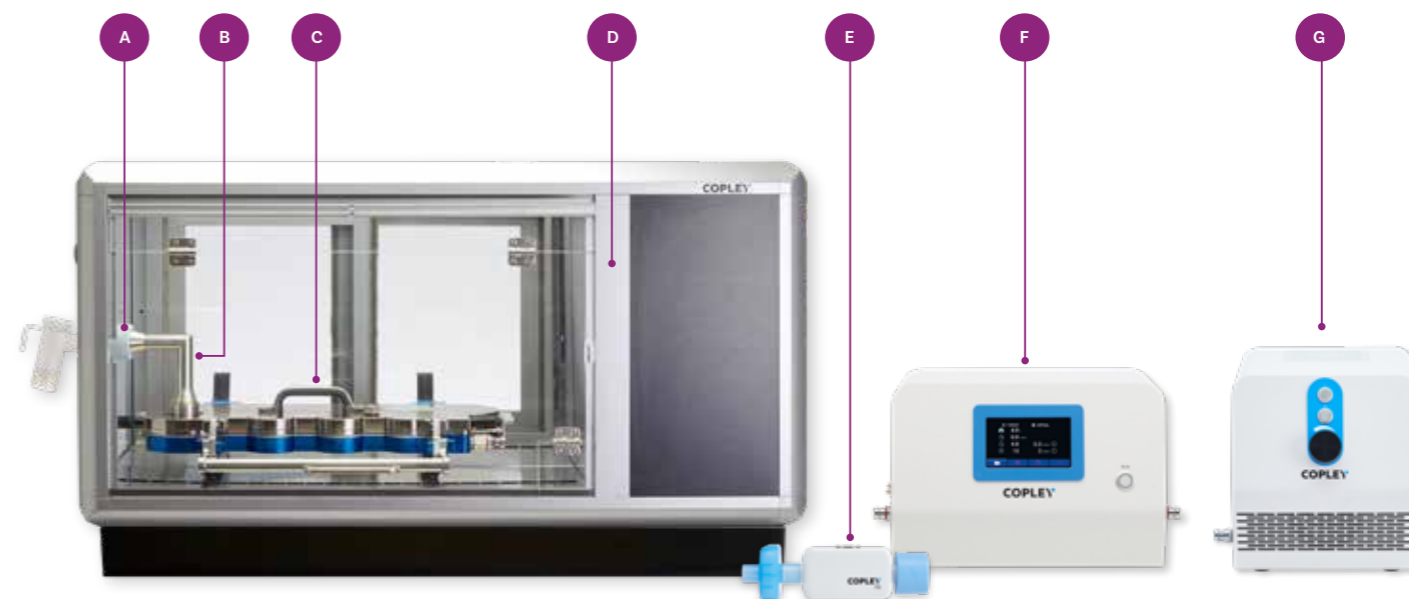

- A Mouthpiece Adapter
- B Induction Port
- C Next Generation Impactor NGI
- D NGI Cooler™
- E Flow Rate Sensor FRS
- F Breath Actuation Controller BAC
- G Vacuum Pump



Determine sampling time (T_s) by balancing the risk of impactor overload with the requirement for analytical sensitivity. Time chosen should be sufficient to ensure an adequate sample is collected for analysis without overloading the collection cups, which causes liquid streaking.

Aerodynamic Particle Size Distribution

Nebulisers

For devices such as nebulisers, the evaporation of droplets exacerbated by the thermal mass of the impactor can be a problem, especially for drugs in solution.

Loss of solvent reduces droplet size, producing artificially low APSD measurements, compromising the integrity of the resulting data. Cooling the impactor to approximately 5°C is the recommended method for overcoming this problem.

The recommended flow rate of 15 L/min employed in the APSD testing of nebulisers is lower than that of other OINDPs in order to better represent the tidal breathing conditions employed in their use.

Regulations and Guidelines



NGI

Organisation	Chapter/Guidance
Ph. Eur. / EMA	2.9.44 App. E
USP / FDA	<1601> App. 6
ChP	0951 App. 3
JP	-

Related Accessories



Temperature and Relative Humidity Sensor

Ideal for measuring environmental test conditions. See page 179.



Footswitch

Connecting directly to the Breath Actuation Controller BAC 100i, the Footswitch enables precise synchronisation of nebuliser device actuation with the onset of flow. See page 179.

Considering the effects of environmental variability?

Our environmental control solutions are designed to help improve the accuracy, sensitivity and reproducibility of test data. Learn more on page 196.



APSD of Nebulisers: Test System Component Parts



Next Generation Impactor NGI

The APSD characterisation of a nebuliser should be conducted using an NGI. This is because the NGI is calibrated for use at 15 L/min and has collection cups well suited to retaining liquid droplets.

In addition to the above, the following is needed to complete a fully-operational test set-up for the APSD measurement of nebulisers:

Vacuum Pump

Designed for optimal operation at low flow rates required for nebuliser testing, the Low Capacity Pump LCP7 represents the latest in high performance, low maintenance, vacuum pump technology. Our Vacuum Pump range is specifically designed for use in the testing of OINDPs in accordance with pharmacopoeial requirements.

See page 188 for further information about our Vacuum Pump range.



Breath Actuation Controller BAC

Ensuring that the volume of air sampled does not exceed the pharmacopoeial specifications, the Breath Actuation Controller model BAC 100i contains an electronically operated, timer-controlled two-way solenoid valve and is positioned between the impactor and Vacuum Pump to control air flow supply to the nebuliser.

See page 172 for further information about our Flow Controller range.

Flow Rate Sensor FRS

Used for establishing accurate and consistent inlet flow rate during testing, the Flow Rate Sensor FRS measures flow rates to the accuracy specified by the pharmacopoeias.

See page 184 for further information about flow rate measurement.



NGI Cooler™

Accommodating the NGI both open and closed, the NGI Cooler allows the NGI to be operated in a temperature controlled environment. Additional space allows for cooling of extra sets of Collection Cups, so multiple tests can be undertaken in quick succession.

See page 202 for further information about the NGI Cooler.



Filter Holder

In most cases, the MOC eliminates the need for a final paper filter, having an 80% collection efficiency of 0.3 micron particles at 30 L/min. If ultra-fine particles are present and at flow rates below 30 L/min, then an internal or external filter holder can be used.

Mouthpiece Adapter

Moulded from high quality silicone rubber, our Mouthpiece Adapters guarantee an airtight seal between the inhaler under test and the test apparatus. For a list of available Mouthpiece Adapters see page 214.

Custom Mouthpiece Adapters are available upon request.

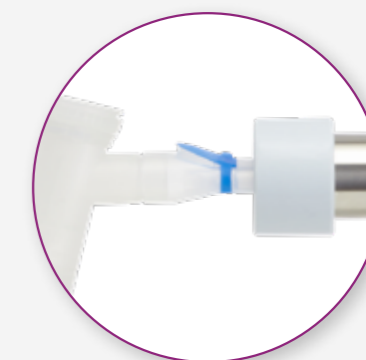

Qualification

GMP regulations require that

- The test methods used to monitor pharmaceuticals must meet proper standards of accuracy and reliability
- Companies should establish procedures to ensure the fitness for use of instruments that generate data supporting product testing

Copley provides a range of qualification documentation, services and tools to meet these requirements.

See page 324 for further information.



Connected Data Management



Data generated using these equipment configurations may be processed and reported through Inhalytix[®]+, Copley's validated data management platform.

By structuring test methods, automating metric calculation and linking results to user attribution and equipment metadata, Inhalytix+ reduces manual data handling and strengthens data integrity. Where compatible ancillary or automation tools are connected, selected operational parameters can be captured automatically alongside analytical results, supporting traceability and regulatory-aligned reporting.

See page 218 to learn how Inhalytix+ can improve workflow efficiency and strengthen data integrity for APSD measurement workflows.

Automation Tools

- Improve efficiency
- Reduce variability
- Eliminate handling errors
- Increase testing capacity



Gentle Rocker™ GR 200i

Promotes easy and fully repeatable dissolution of active drug present on NGI Collection Cup and ACI Collection Plate surfaces prior to analysis. See page 310.

Recommended for:



Sample Recovery System SRS 100i

Provides controlled recovery from impactor stages, preseparators and induction ports to support consistent sample preparation prior to analysis. See page 302.

Recommended for:



Sample Preparation Unit SPU 200i

Simplifies and standardises drug recovery from induction ports and preseparators. See page 314.

Recommended for:



Impactor Cleaning System

Standardises cleaning and drying procedures to help ensure the NGI and ACI remain in optimum condition throughout their life. See page 320.

Recommended for:

Related Applications

We also offer a range of equipment for additional nebuliser testing application support:



For facemask testing

See page 250



For better *in vitro-in vivo* correlation (IVIVC) testing

See page 226

Training, Servicing & Support

We offer a comprehensive range of services from bespoke product design to installation, expert training and technical support, optimising all aspects of pharmaceutical testing from start to finish.



Training

See page 335



Servicing

See page 330

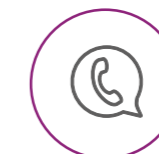

Support

See page 334



Design

See page 335





APSD of SMIs Test System Set-Up

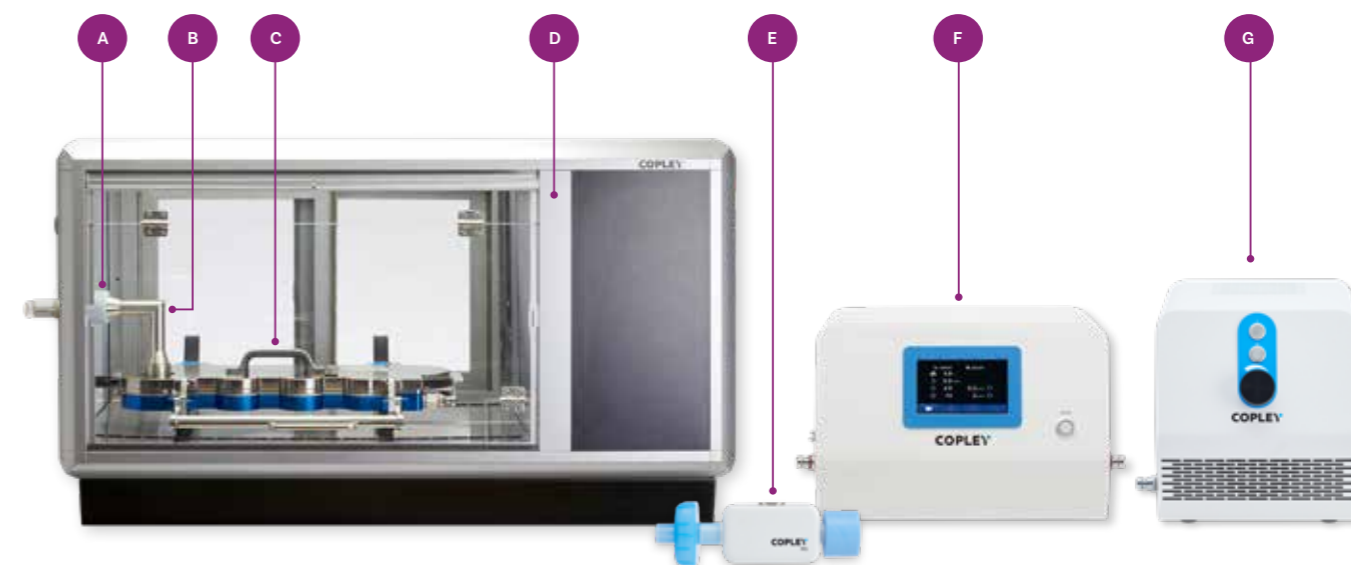

- A Mouthpiece Adapter
- B Induction Port
- C Next Generation Impactor NGI
- D NGI Cooler™
- E Flow Rate Sensor FRS
- F Breath Actuation Controller BAC
- G Vacuum Pump

Alternative Impactors/Impingers



TOP TIP
If working on generic development of an SMI where the Reference product was registered using an ACI, the NGI Cooler can also be used with the ACI to control impactor temperature.

Considering the effects of environmental variability?

Our environmental control solutions are designed to help improve the accuracy, sensitivity and reproducibility of test data.
Learn more on page 196.

Aerodynamic Particle Size Distribution Soft Mist Inhalers (SMIs)

For SMIs as for nebulisers, the evaporation of droplets exacerbated by the thermal mass of the impactor can be a problem.



Loss of solvent reduces droplet size, producing artificially low APSD measurements, compromising the integrity of the resulting data. Cooling the impactor to approximately 5°C is the recommended method for overcoming this problem.

Classified as active devices, the recommended flow rate for SMI testing is 28.3 L/min for the ACI or 30 L/min for the NGI.

Regulations and Guidelines

Whilst there is no current pharmacopoeial or regulatory guidance for SMIs, they are considered to combine the metered-dose technology of MDIs with the aqueous

aerosol droplet generation of nebulisers. Testing, and the equipment that features in this section, reflects this combined technology.

	Organisation	Chapter/Guidance
 NGI	Ph. Eur. / EMA	2.9.44 App. E
	USP / FDA	<601> App. 6
	ChP	0951 App. 3
	JP	6.15.5 App. 3
	Organisation	Chapter/Guidance
 ACI	Ph. Eur. / EMA	-
	USP / FDA	App. 1
	ChP	App. 2
	JP	App. 2

Related Accessories



Temperature and Relative Humidity Sensor

Ideal for measuring environmental test conditions. See page 179.



Footswitch

Connecting directly to the Breath Actuation Controller BAC 1001, the Footswitch enables precise synchronisation of SMI device actuation with the onset of flow. See page 179.

APSD of SMIs: Test System Component Parts

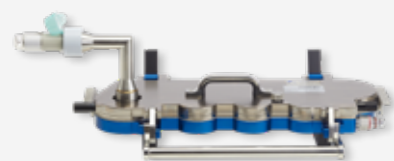

Next Generation Impactor NGI

The recommended test set-up is with an NGI. An ACI can also be used for the assessment of SMIs.



In addition to the above, the following is needed to complete a fully-operational test set-up for the APSD measurement of SMIs:

Vacuum Pump

Designed for optimal operation at low flow rates required for SMI testing, the Low Capacity Pump LCP7 represents the latest in high performance, low maintenance, vacuum pump technology. Our Vacuum Pump range is specifically designed for use in the testing of OINDPs in accordance with pharmacopoeial requirements.

See page 188 for further information about our Vacuum Pump range.



Required for:



Breath Actuation Controller BAC

Ensuring that the volume of air sampled does not exceed the pharmacopoeial specifications, the Breath Actuation Controller BAC 100i contains an electronically operated, timer-controlled two-way solenoid valve and is positioned between the impactor and Vacuum Pump to control air flow supply to the inhaler.

See page 172 for further information about our Flow Controller range.

Recommended for:



Flow Rate Sensor FRS

Used for establishing accurate and consistent inlet flow rate during testing, the Flow Rate Sensor FRS measures flow rates to the accuracy specified by the pharmacopoeias.

See page 184 for further information about flow rate measurement.

Required for:

NGI Cooler™

Accommodating the NGI both open and closed, the NGI Cooler allows the NGI to be operated in a temperature controlled environment. The NGI Cooler can also be used with the ACI. The additional space inside facilitates the cooling of extra sets of collection cups/multiple ACIs, allowing multiple tests to be undertaken efficiently.

See page 202 for further information about the NGI Cooler.

Required for:



Mouthpiece Adapter

Moulded from high quality silicone rubber, our Mouthpiece Adapters guarantee an airtight seal between the inhaler under test and the test apparatus. For a list of available Mouthpiece Adapters see page 214.

Custom Mouthpiece Adapters are available upon request.

Required for:

Qualification

GMP regulations require that

- The test methods used to monitor pharmaceuticals must meet proper standards of accuracy and reliability
- Companies should establish procedures to ensure the fitness for use of instruments that generate data supporting product testing

Copley provides a range of qualification documentation, services and tools to meet these requirements.

See page 324 for further information.



Connected Data Management



Data generated using these equipment configurations may be processed and reported through Inhalytix[®]+, Copley's validated data management platform.

By structuring test methods, automating metric calculation and linking results to user attribution and equipment metadata, Inhalytix+ reduces manual data handling and strengthens data integrity. Where compatible ancillary or automation tools are connected, selected operational parameters can be captured automatically alongside analytical results, supporting traceability and regulatory-aligned reporting.

See page 218 to learn how Inhalytix+ can improve workflow efficiency and strengthen data integrity for APSD measurement workflows.

Automation Tools

- Improve efficiency
- Reduce variability
- Eliminate handling errors
- Increase testing capacity



Gentle Rocker™ GR 200i

Promotes easy and fully repeatable dissolution of active drug present on NGI Collection Cup and ACI Collection Plate surfaces prior to analysis. See page 310.

Recommended for:



Sample Recovery System SRS 100i

Provides controlled recovery from impactor stages, preseparators and induction ports to support consistent sample preparation prior to analysis. See page 302.

Recommended for:



Sample Preparation Unit SPU 200i

Simplifies and standardises drug recovery from induction ports and preseparators. See page 314.

Recommended for:



Impactor Cleaning System

Standardises cleaning and drying procedures to help ensure the NGI and ACI remain in optimum condition throughout their life. See page 320.

Recommended for:

Related Applications

We also offer a range of equipment for additional SMI testing application support:



For better *in vitro-in vivo* correlation (IVIVC) testing

See page 226

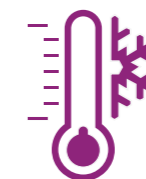

For cold Freon[®] effect testing

See page 261



For USP product-specific monographs

See page 274

Training, Servicing & Support

We offer a comprehensive range of services from bespoke product design to installation, expert training and technical support, optimising all aspects of pharmaceutical testing from start to finish.



Training
See page 335



Servicing
See page 330

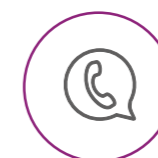

Support
See page 334



Design
See page 335





Aerodynamic Particle Size Distribution Nasal Sprays

Nasal sprays typically produce droplets in the range 20-200 microns, which is outside the effective range of cascade impactors. However, most sprays deliver a proportion (typically <5%) of fine droplets in the <10 micron range.

It is important to quantify the amount of droplets in this range since it is the amount of dose that can penetrate beyond the nasal tract and into the lower respiratory tract or lungs, which may be undesirable.

Regulators recommend the use of a cascade impactor in conjunction with a high volume expansion chamber to quantify the amount of drug in the <10 micron range, to assess the potential risk of deposition in the lungs.

Regulations and Guidelines

	Organisation	Chapter/Guidance
 NGI	Ph. Eur. / EMA	Guideline on the Pharmaceutical Quality of Inhalation and Nasal Products
	USP / FDA	Nasal Spray and Inhalation Solution, Suspension, and Spray Drug Products – Chemistry, Manufacturing, and Controls Documentation
	ChP	-
	JP	-
 ACI	Organisation	Chapter/Guidance
	Ph. Eur. / EMA	-
	USP / FDA	Nasal Spray and Inhalation Solution, Suspension, and Spray Drug Products – Chemistry, Manufacturing, and Controls Documentation
	JP	-
 GTI	Organisation	Chapter/Guidance
	Ph. Eur. / EMA	-
	USP / FDA	-
	JP	-

APSD of Nasal Sprays Automated Test System Set-Up

Routine APSD test set-ups for nasal sprays are easily automated with Vertus® III. Compatible with most nasal sprays, the Vertus III systems simplify the aerodynamic particle size distribution measurement of nasal sprays in accordance with Ph. Eur. Chapter 0676 and USP Chapter <601>.

The Vertus III range offer analysts complete control over:

- The speed, angle and duration of shaking, ahead of actuation
- Firing force and the speed of application and release of that force
- The time delay between the end of shaking and device actuation

Vertus III+ with Next Generation Impactor NGI and Glass Expansion Chamber



Automated shot weight measurement via an integrated balance

- A Vertus III+ with Balance
- B Glass Expansion Chamber
- C Next Generation Impactor NGI

Alternative Vertus® III Interface Plates



For more information about automation with the Vertus® range, see page 292.

Manual Test System Set-Up

We offer **Glass Expansion Chambers** suitable for the quantification of nasal spray drug product present in the form of particles or droplets that are less than 10 microns.

We offer two sizes for the characterisation of nasal sprays:

2 L chamber: to maximise aerosolisation and impactor deposition for regular nasal sprays.

5 L chamber: for powerful nasal sprays where increased volume is required to allow a full aerosol plume to generate.

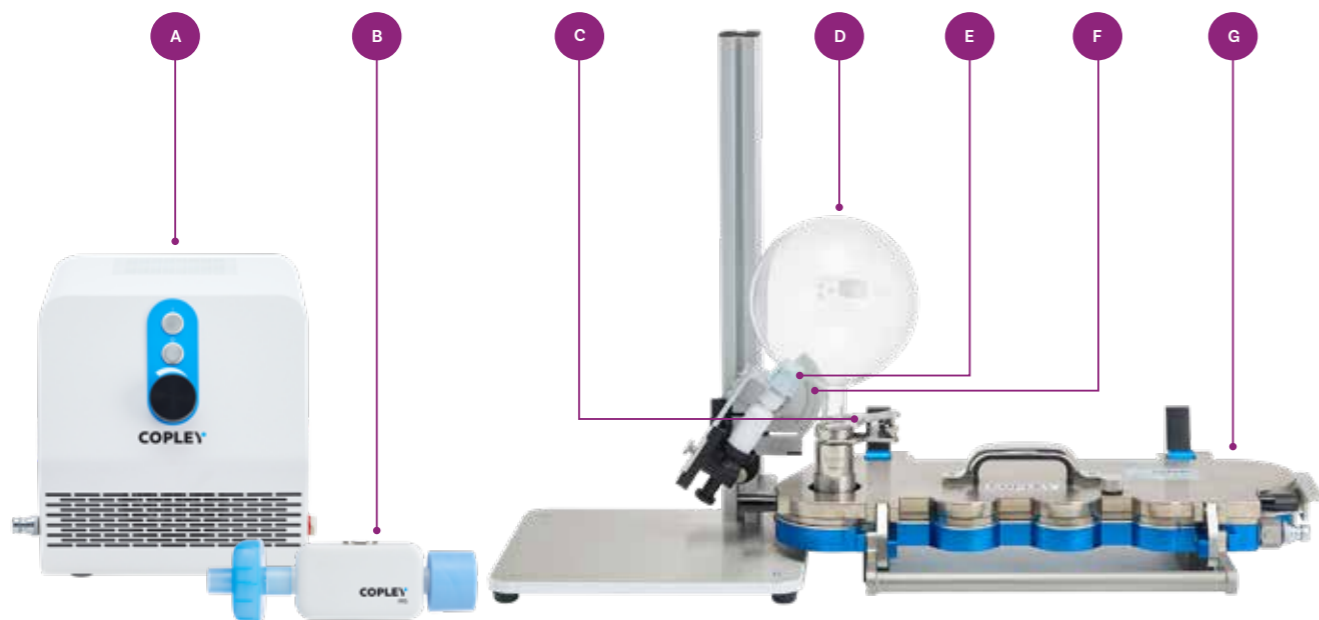

- A** Vacuum Pump
- B** Flow Rate Sensor FRS
- C** Adapter and Clamp
- D** Glass Expansion Chamber
- E** Nosepiece Adapter
- F** Angled Nasal Device Holder
- G** Next Generation Impactor NGI

Considering the effects of environmental variability?

Our environmental control solutions are designed to help improve the accuracy, sensitivity and reproducibility of test data.

Learn more on page 196.

Alternative Impactors/Impingers



Andersen Cascade Impactor ACI with Glass Expansion Chamber



Fast Screening Andersen FSA with Glass Expansion Chamber



Glass Twin Impinger GTI



Kiel Nasal Inlet KNI

Alternative Configuration

For more information about automation with the Vertus® range, see page 292.

Qualification

GMP regulations require that

- The test methods used to monitor pharmaceuticals must meet proper standards of accuracy and reliability
- Companies should establish procedures to ensure the fitness for use of instruments that generate data supporting product testing



Copley provides a range of qualification documentation, services and tools to meet these requirements. See page 324 for further information.

Connected Data Management



Data generated using these equipment configurations may be processed and reported through Inhalytix+, Copley's validated data management platform.

By structuring test methods, automating metric calculation and linking results to user attribution and equipment metadata, Inhalytix+ reduces manual data handling and strengthens data integrity. Where compatible ancillary or automation tools are connected, selected operational parameters can be captured automatically alongside analytical results, supporting traceability and regulatory-aligned reporting.

See page 218 to learn how Inhalytix+ can improve workflow efficiency and strengthen data integrity for APSD measurement workflows.

Automation Tools

- Improve efficiency
- Reduce variability
- Eliminate handling errors
- Increase testing capacity



Gentle Rocker™ GR 200i

Promotes easy and fully repeatable dissolution of active drug present on NGI Collection Cup and ACI Collection Plate surfaces prior to analysis. See page 310.

Recommended for:



Sample Recovery System SRS 100i

Provides controlled recovery from impactor stages, pre-separators and induction ports to support consistent sample preparation prior to analysis. See page 302.

Recommended for:



Impactor Cleaning System

Standardises cleaning and drying procedures to help ensure the NGI and ACI remain in optimum condition throughout their life. See page 320.

Recommended for:

Related Applications

We also offer a range of equipment for additional nasal spray testing application support:



For better *in vitro-in vivo* correlation (IVIVC) testing

See page 226

Training, Servicing & Support

We offer a comprehensive range of services from bespoke product design to installation, expert training and technical support, optimising all aspects of pharmaceutical testing from start to finish.



Training

See page 335



Servicing

See page 330



Support

See page 334



Design

See page 335

Aerodynamic Particle Size Distribution

Nasal Aerosols

Like nasal sprays, nasal aerosols typically produce droplets in the range 20-200 microns, which is outside the effective range of cascade impactors. However, nasal aerosols deliver a proportion (typically <5%) of fine droplets in the <10 micron range. Unlike nasal sprays, nasal aerosols are propellant-driven.

It is important to quantify this FPD since it can penetrate beyond the nasal tract and into the lower respiratory tract or lungs, which may be undesirable. Regulators recommend the use of a cascade impactor

in conjunction with a high volume expansion chamber to quantify the amount of drug in the <10 micron range, to assess the potential risk of deposition in the lungs.

Regulations and Guidelines

	Organisation	Chapter/Guidance
<p>NGI</p>	Ph. Eur. / EMA	Guideline on the Pharmaceutical Quality of Inhalation and Nasal Products
	USP / FDA	Nasal Spray and Inhalation Solution, Suspension, and Spray Drug Products – Chemistry, Manufacturing, and Controls Documentation
	ChP	-
	JP	-
<p>ACI</p>	Organisation	Chapter/Guidance
	Ph. Eur. / EMA	-
	USP / FDA	Nasal Spray and Inhalation Solution, Suspension, and Spray Drug Products – Chemistry, Manufacturing, and Controls Documentation
	ChP	-
	JP	-

APSD of Nasal Aerosols Automated Test System Set-Up

Routine APSD test set-ups for nasal aerosols are easily automated with Vertus® III. Compatible with most nasal aerosols, the Vertus III systems simplify the aerodynamic particle size distribution measurement of nasal aerosols in accordance with Ph. Eur. Chapter 0676 and USP Chapter <601>.

The Vertus III range offer analysts complete control over:

- The speed, angle and duration of shaking, ahead of actuation
- Firing force and the speed of application and release of that force
- The time delay between the end of shaking and device actuation

Vertus III+ with Next Generation Impactor NGI and Glass Expansion Chamber



- (A) Vertus III+ with Balance
- (B) Glass Expansion Chamber
- (C) Next Generation Impactor NGI

Manual Test System Set-Up

We offer **Glass Expansion Chambers** suitable for the quantification of nasal aerosol drug product present in the form of particles or droplets that are less than 10 microns.

We offer one size ideal for the characterisation of nasal aerosols:

1 L chamber: to maximise drug deposition below the top stage of the impactor.

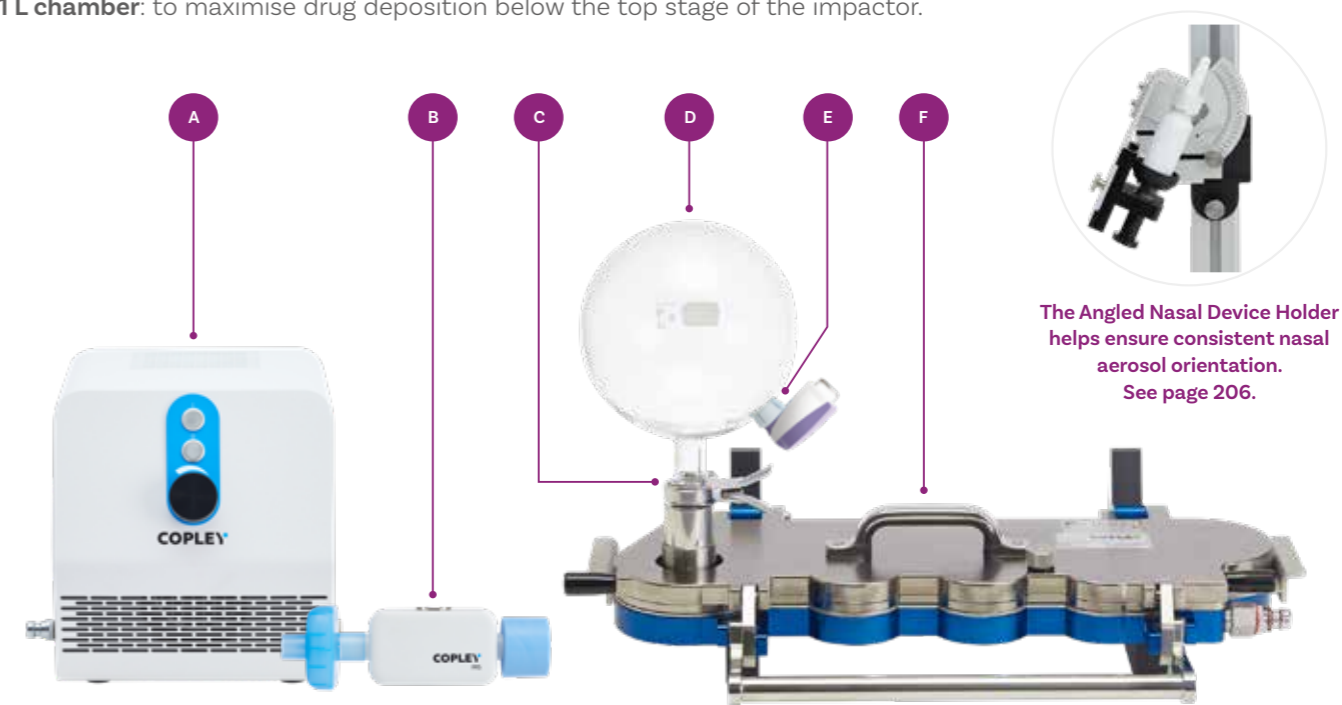

- (A) Vacuum Pump Page 188
- (B) Flow Sensor Page 184
- (C) Adapter and Clamp Page 208
- (D) Glass Expansion Chamber Page 208
- (E) Nosepiece Adapter Page 214
- (F) Next Generation Impactor NGI Page 84

Considering the effects of environmental variability?

Our environmental control solutions are designed to help improve the accuracy, sensitivity and reproducibility of test data.

Learn more on page 196.

Alternative Vertus® III Interface Plates



Andersen Cascade Impactor ACI with Glass Expansion Chamber



Fast Screening Andersen FSA with Glass Expansion Chamber



Kiel Nasal Inlet KNI

Alternative Impactors/Impingers



Andersen Cascade Impactor ACI with Glass Expansion Chamber



Fast Screening Andersen FSA with Glass Expansion Chamber



Kiel Nasal Inlet KNI

Alternative Configuration

For more information about automation with the Vertus® range, see page 292.

Qualification

GMP regulations require that

- The test methods used to monitor pharmaceuticals must meet proper standards of accuracy and reliability
- Companies should establish procedures to ensure the fitness for use of instruments that generate data supporting product testing



Copley provides a range of qualification documentation, services and tools to meet these requirements. See page 324 for further information.

Connected Data Management



Data generated using these equipment configurations may be processed and reported through Inhalytix[®]+, Copley's validated data management platform.

By structuring test methods, automating metric calculation and linking results to user attribution and equipment metadata, Inhalytix+ reduces manual data handling and strengthens data integrity. Where compatible ancillary or automation tools are connected, selected operational parameters can be captured automatically alongside analytical results, supporting traceability and regulatory-aligned reporting.

See page 218 to learn how Inhalytix+ can improve workflow efficiency and strengthen data integrity for APSD measurement workflows.

Automation Tools



Improve efficiency



Reduce variability



Eliminate handling errors



Increase testing capacity



Gentle Rocker™ GR 200i

Promotes easy and fully repeatable dissolution of active drug present on NGI Collection Cup and ACI Collection Plate surfaces prior to analysis. See page 310.

Recommended for:   



Sample Recovery System SRS 100i

Provides controlled recovery from impactor stages, preseparators and induction ports to support consistent sample preparation prior to analysis. See page 302.

Recommended for:   



Impactor Cleaning System

Standardises cleaning and drying procedures to help ensure the NGI and ACI remain in optimum condition throughout their life. See page 320.

Recommended for:   

Related Applications

We also offer a range of equipment for additional nasal aerosol testing application support:



For better *in vitro-in vivo* correlation (IVIVC) testing

See page 226

Training, Servicing & Support

We offer a comprehensive range of services from bespoke product design to installation, expert training and technical support, optimising all aspects of pharmaceutical testing from start to finish.



Training
See page 335



Servicing
See page 330

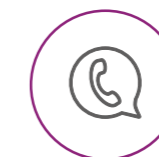

Support
See page 334



Design
See page 335

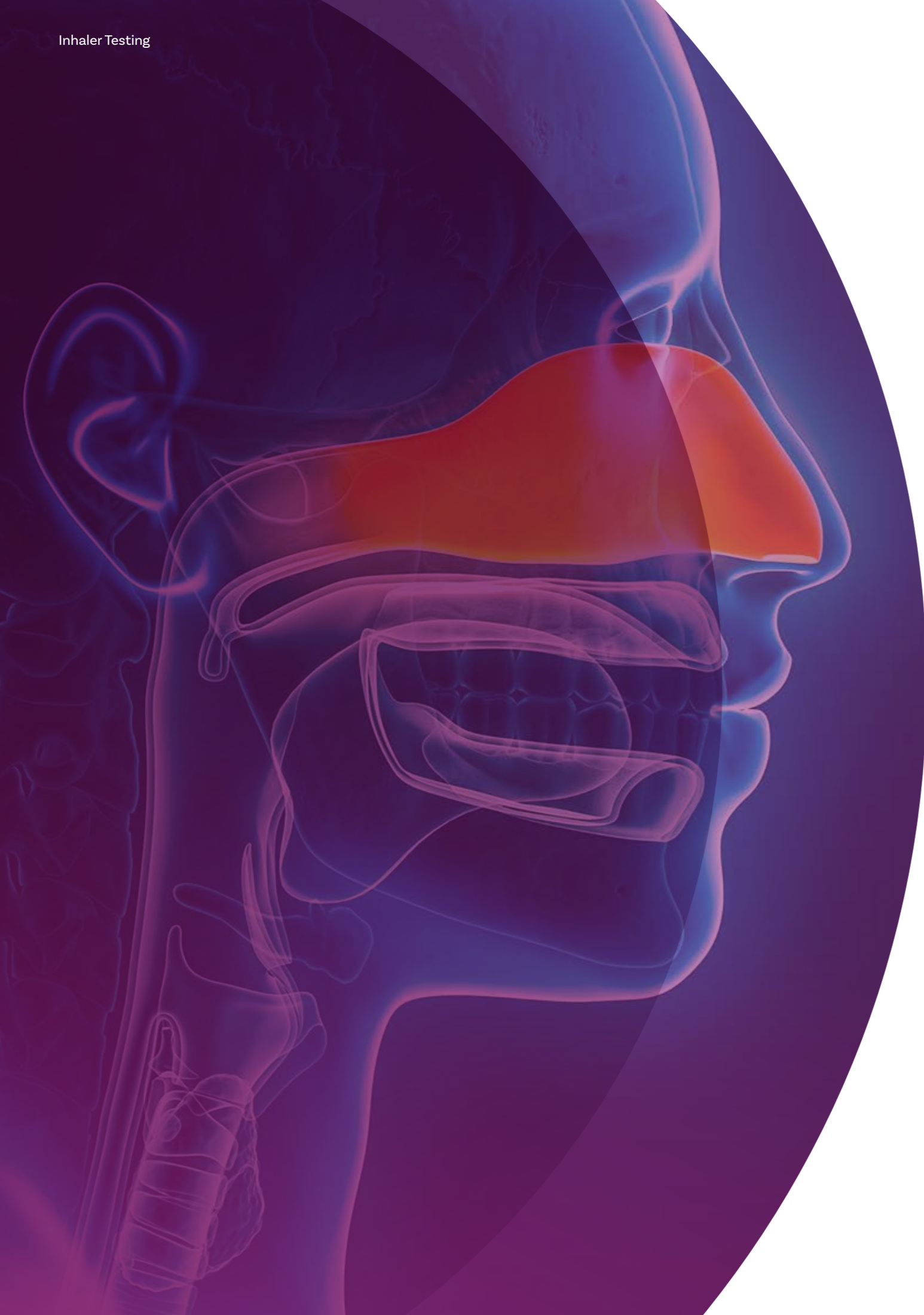



Aerodynamic Particle Size Distribution Nasal Powders

Like nasal sprays and aerosols, nasal powders typically produce droplets in the range 20-200 microns, which is outside the effective range of cascade impactors. However, nasal powders deliver a proportion (typically <5%) of fine droplets in the <10 micron range.

It is important to quantify this FPD since it can penetrate beyond the nasal tract and into the lower respiratory tract or lungs, which may be undesirable. Regulators recommend the use of a cascade impactor to quantify the amount of drug in the <10 micron range, to assess the potential risk of deposition in the lungs.

The APSD measurement of nasal powders is typically performed under similar conditions as the APSD measurement of DPIs. However a preseparator is not required.

Regulations and Guidelines

	Organisation	Chapter/Guidance
 <p>NGI</p>	Ph. Eur. / EMA	Guideline on the Pharmaceutical Quality of Inhalation and Nasal Products
	USP / FDA	Nasal Spray and Inhalation Solution, Suspension, and Spray Drug Products – Chemistry, Manufacturing, and Controls Documentation
	ChP	-
	JP	-
 <p>ACI</p>	Organisation	Chapter/Guidance
	Ph. Eur. / EMA	-
	USP / FDA	Nasal Spray and Inhalation Solution, Suspension, and Spray Drug Products – Chemistry, Manufacturing, and Controls Documentation
	ChP	-
	JP	-

APSD of Nasal Powders Test System Set-Up

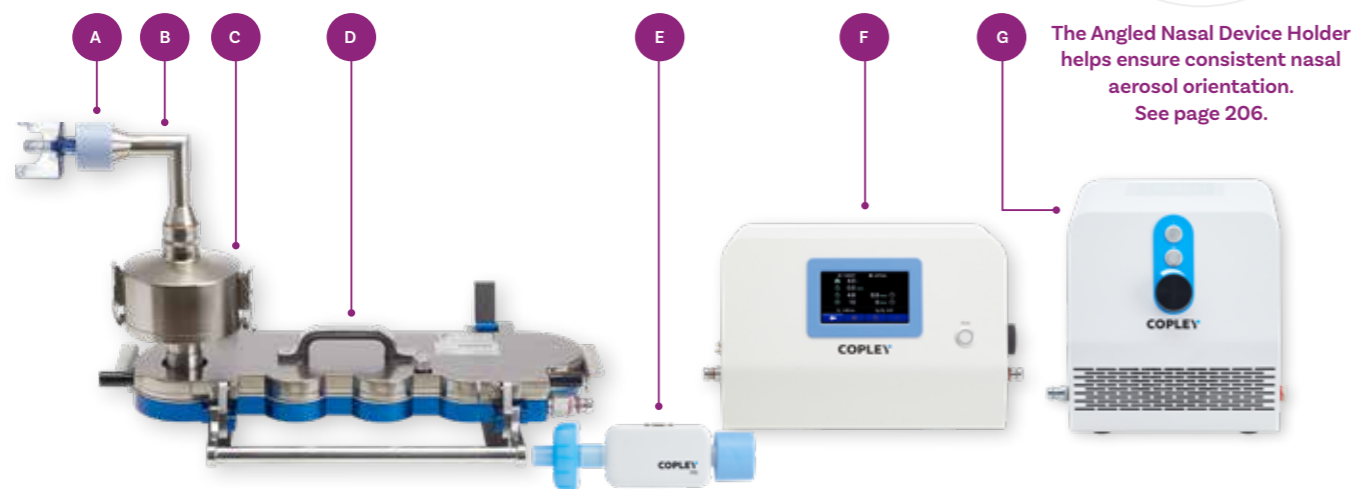

- A** Nosepiece Adapter
- B** Induction Port
- C** Preseparator
- D** Next Generation Impactor NGI
- E** Flow Rate Sensor FRS
- F** Critical Flow Controller TPK
- G** Vacuum Pump

Alternative Impactors/Impingers



Considering the effects of environmental variability?

Our environmental control solutions are designed to help improve the accuracy, sensitivity and reproducibility of test data.

Learn more on page 196.



Related Accessories



Temperature and Relative Humidity Sensor

Ideal for measuring environmental test conditions. See page 183.



Footswitch

Connecting directly to the Critical Flow Controller TPK 100i, the Footswitch enables the precise synchronisation of nasal powder device actuation with the onset of flow. See page 183.



Kiel Nasal Inlet KNI

APSD of Nasal Powders: Test System Component Parts

Next Generation Impactor NGI

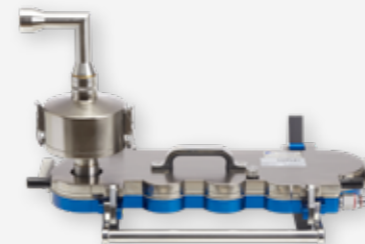

The test set-up is shown with an NGI but an ACI is equally suitable for the assessment of nasal powders. The Fast Screening Andersen (FSA) impactor is a reduced stack plus filter version of the ACI. As little deposition is expected in the lower stages, the FSA may be used to assess the APSD characteristics of nasal powders.

A Preseparator may be required for the collection of large mass, non-inhalable powder boluses that may be emitted, prior to entry into the impactor. Different preseparators are available for the NGI, ACI (and FSA).

See page 267 for further information about the FSA.



In addition to the above, the following is needed to complete a fully-operational test set-up for the APSD measurement of nasal powders:

Vacuum Pump

Ideal for the higher, sonic flow rate testing requirements of nasal powders, the High Capacity Pump HCP7 and Super Capacity Pump SCP7 represent the latest in high performance, low maintenance, vacuum pump technology. Our Vacuum Pump range is specifically designed for use in the testing of OINDPs in accordance with pharmacopoeial requirements.

See page 188 for further information about our Vacuum Pump range.



Required for:

Critical Flow Controller TPK



Simplify nasal powder test system set-up in accordance with pharmacopoeial recommendations with the Critical Flow Controller series. Positioned between the impactor and vacuum pump, the Critical Flow Controller TPK 100i ensures critical (sonic) flow conditions during testing. It measures and records all parameters required for testing and for controlling flow conditions.

See page 172 for further information about our Flow Controller range.

Required for:

Flow Rate Sensor FRS

Used for establishing accurate and consistent inlet flow rate during testing, the Flow Rate Sensor FRS measures flow rates to the accuracy specified by the pharmacopoeias.

See page 184 for further information about flow rate measurement.



Required for:

Inhaler Testing Workstation™ ITW

Designed to keep the apparatus organised during testing and improve workflow efficiency, the Inhaler Testing Workstation ITW keeps the cascade impactor and flow meter in position throughout the testing process.

See page 204 for further information.

Recommended for: 



Nosepiece Adapter

Special Nosepiece Adapters are available to accommodate the nasal powder device and interface it with the test set-up.

See page 214 for further information.

Required for: 

Qualification

GMP regulations require that

- The test methods used to monitor pharmaceuticals must meet proper standards of accuracy and reliability
- Companies should establish procedures to ensure the fitness for use of instruments that generate data supporting product testing



Copley provides a range of qualification documentation, services and tools to meet these requirements.

See page 324 for further information.

Connected Data Management



Data generated using these equipment configurations may be processed and reported through Inhalytix^{®+}, Copley's validated data management platform.

By structuring test methods, automating metric calculation and linking results to user attribution and equipment metadata, Inhalytix+ reduces manual data handling and strengthens data integrity. Where compatible ancillary or automation tools are connected, selected operational parameters can be captured automatically alongside analytical results, supporting traceability and regulatory-aligned reporting.

See page 218 to learn how Inhalytix+ can improve workflow efficiency and strengthen data integrity for APSD measurement workflows.

Automation Tools

-  Improve efficiency
-  Reduce variability
-  Eliminate handling errors
-  Increase testing capacity



Impactor Coater™ IC 200i

Standardises impaction surface coating for both NGI Collection Cups and ACI Collection Plates. See page 308.

Recommended for: 



Gentle Rocker™ GR 200i

Promotes easy and fully repeatable dissolution of active drug present on NGI Collection Cup and ACI Collection Plate surfaces prior to analysis. See page 310.

Recommended for: 



Impactor Genie™ IG 200i

An innovative 2-in-1 solution combining the coating capabilities of the Impactor Coater IC 200i with the drug recovery features of the Gentle Rocker GR 200i. See page 312.

Recommended for: 



Sample Recovery System SRS 100i

Provides controlled recovery from impactor stages, preseparators and induction ports to support consistent sample preparation prior to analysis. See page 302.

Recommended for: 



Sample Preparation Unit SPU 200i

Simplifies and standardises drug recovery from the Induction Ports and Preseparators. See page 314.

Recommended for: 



Impactor Cleaning System

Standardises cleaning and drying procedures to help ensure the NGI and ACI remain in optimum condition throughout their life. See page 320.

Recommended for: 

Related Applications

We also offer a range of equipment for additional nasal powder testing application support:



For better *in vitro-in vivo* correlation (IVIVC) testing

See page 226

Training, Servicing & Support

We offer a comprehensive range of services from bespoke product design to installation, expert training and technical support, optimising all aspects of pharmaceutical testing from start to finish.



Training

See page 335



Servicing

See page 330

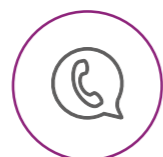

Support

See page 334



Design

See page 335



Ancillaries

This chapter describes the ancillaries required in addition to the Dosage Unit Sampling Apparatus (DUSA) and cascade impactor to make up a fully-operational test set-up for determining the Delivered Dose Uniformity (DDU) and Aerodynamic Particle Size Distribution (APSD) of orally inhaled and nasal drug products (OINDPs).

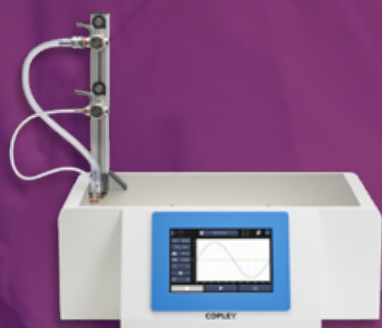

Breathing Simulators

Used to apply a more clinically representative breathing profile (relative to a constant flow rate) during testing, our range of Breathing Simulators cover the variety of breathing patterns found in neonatal, infant, child and adult physiologies.

See page 156.

Flow Controllers

Our range of flow controllers enable precise control of airflow rate and volume for inhaler and nasal drug product testing. Supporting defined, repeatable test conditions required by pharmacopoeial methods, they are suitable for both active and passive devices and help streamline routine testing workflows.

See page 172.



Flow Rate Measurement

Flow rate is a critical parameter in the *in vitro* testing of OINDPs. We offer two devices for measuring flow rate with the required range and accuracy to ensure accurate and consistent inlet flow rate during testing. Both units will give similar readings provided they are calibrated and operated correctly.

See page 184.



Vacuum Pumps

Driving most inhaler testing systems is the vacuum pump. We offer a choice of three Vacuum Pumps dependent on the system set-up and the capacity required.

See page 188.



Environmental Control

Our range of environmental control tools are designed to help mitigate the impact of localised environmental conditions on OINDP test data integrity.

See page 194.

NGI Cooler™

Designed to maintain the integrity of the APSD data of aerolised droplets by eliminating evaporation induced by the thermal mass of the impactor, the NGI Cooler provides a temperature-controlled environment for testing.

See page 204.



Inhaler Testing Workstation™ ITW

Providing an 'extra pair of hands', the ITW holds key test equipment in place during testing. Available with attachments to support both DDU and APSD testing, the versatile ITW is the ideal benchtop companion for busy analysts.

See page 196.

Glass Expansion Chambers

Ideal for maximising the aerolisation of nasal drug products in the assessment of fine particles by cascade impaction, Glass Expansion Chambers are available for a wide range of nasal drug product applications.

See page 208.



Kiel Nasal Inlet KNI

Provides a controlled interface for consistent nasal dose collection, supporting representative testing of nasal drug products for both DDU testing and APSD measurement.

See page 212.

Mouthpiece & Nosepiece Adapters

Our high quality silicone Mouthpiece and Nosepiece adapters are available for the most common devices on the market. A custom design service is also available for other devices.

See page 214.





Ancillaries

Breathing Simulators

Our range of Breathing Simulators are designed to generate an inhalation and/or exhalation profile that mimics that of a human subject for more clinically representative testing.

Replacing the fixed flow rate normally used for regulatory testing with a breathing profile has become routine in orally inhaled product (OIP) assessment, with more and more laboratories turning to the use of

breathing simulators to measure the effects of different breathing profiles, flow rates and breathing techniques during product development.

Their use has two major applications:



Pharmacopoeial

To assess the DDU of:

1. Nebulisers as per Ph. Eur. 2.9.44 and USP chapter <1601>.
2. MDIs when used together with spacers and valved holding chambers, as per USP <1602>.



Improving *in vitro-in vivo* correlations (IVIVCs)

To apply more clinically representative conditions during *in vitro* testing so as to generate data that are more relevant to *in vivo* behaviour.

TOP TIP

The use of breathing simulators is supported by the **Quality by Design (QbD)** strategy outlined in ICH Q8, which relies on scoping the potential impact of any variability that may arise from, for example, difference in patient physiology or technique.

Choose your Breathing Simulator

From the generation of simple sinusoidal patterns stated in USP and Ph.Eur. for testing of nebulisers and MDIs with a spacer/VHC to complex user-generated profiles for improving *in-vitro in-vivo* correlations (IVIVCs), our range of versatile Breathing Simulators can be used for a variety of testing applications.

BRS 100i	BRS 200i	BRS 300i
<p>Relevant Applications</p> <ul style="list-style-type: none"> Testing nebulisers Testing MDIs with a spacer/VHC 	<p>Relevant Applications</p> <ul style="list-style-type: none"> Testing nebulisers Testing MDIs with a spacer/VHC Improving IVIVCs for MDIs with a spacer/VHC and nebulisers: <ul style="list-style-type: none"> With Filter Holder and Adapter (DDU) With Impactor and Mixing Inlet (APSD) Improving IVIVCs for nasal products 	<p>Relevant Applications</p> <ul style="list-style-type: none"> Limited testing of nebulisers Testing MDIs with a spacer/VHC Improving IVIVCs for MDIs and DPIs: <ul style="list-style-type: none"> With DUSA for MDI/DPI (DDU) With Impactor and Mixing Inlet (APSD) Improving IVIVCs for nasal products
<p>Volume</p> <p>0 to 800 mL</p>	<p>Volume</p> <p>0 - 155 mL 0 - 900 mL</p>	<p>Volume</p> <p>0 to 5000 mL</p>
<p>Patient Profile Suitability</p> <ul style="list-style-type: none"> Neonate/Infant ✓ Child ✓ Adult ✓ 	<p>Patient Profile Suitability</p> <ul style="list-style-type: none"> Neonate/Infant ✓ Child ✓ Adult ✓ 	<p>Patient Profile Suitability</p> <ul style="list-style-type: none"> Neonate/Infant ✗ Child ✗ Adult ✓
<p>21 CFR Part 11 Compliant</p> <p>N/A</p>	<p>21 CFR Part 11 Compliant</p> <p>✓</p>	<p>21 CFR Part 11 Compliant</p> <p>✓</p>
<p>Frequency</p> <p>12 - 40 bpm</p>	<p>Frequency</p> <p>6 - 60 bpm</p>	<p>Frequency</p> <p>6 - 60 bpm</p>
<p>I:E Ratio</p> <p>1:1, 1:2 or 1:3</p>	<p>I:E Ratio</p> <p>Variable</p>	<p>I:E Ratio</p> <p>Variable</p>
<p>Waveforms</p> <ul style="list-style-type: none"> Sinusoidal ✓ Square ✗ Triangular ✗ User-defined ✗ 	<p>Waveforms</p> <ul style="list-style-type: none"> Sinusoidal ✓ Square ✓ Triangular ✓ User-defined ✓ (flow vs time) 	<p>Waveforms</p> <ul style="list-style-type: none"> Sinusoidal ✓ Square ✓ Triangular ✓ User-defined ✓ (flow vs time)
<p>Profiles</p> <ul style="list-style-type: none"> Inhalation ✓ Exhalation ✓ 	<p>Profiles</p> <ul style="list-style-type: none"> Inhalation ✓ Exhalation ✓ 	<p>Profiles</p> <ul style="list-style-type: none"> Inhalation ✓ Exhalation ✓
<p>Control: Start</p> <ul style="list-style-type: none"> On inhalation ✓ On exhalation ✓ User-defined ✗ 	<p>Control: Start</p> <ul style="list-style-type: none"> On inhalation ✓ On exhalation ✓ User-defined ✓ 	<p>Control: Start</p> <ul style="list-style-type: none"> On inhalation ✓ On exhalation ✓ User-defined ✓



Breathing Simulator BRS 100i



Ph. Eur. 2.9.44 compliant



USP <1601> and <1602> compliant



ISO 27427:2013 compliant



Touchscreen user interface



MDI Actuation Sensor/ Footswitch remote start capability



Selectable start position (inhalation or exhalation) for spacers/VHCs



Extensive data output options

Key Features:



Piston/cylinder arrangement driven by motor with accurate speed and position control



Compatible with MDI Actuation Sensor and Footswitch for coordinated testing



In-line arrangement for convenient test set-up



Intuitive touchscreen control with icon-based menu structure simplifies operation and clearly displays test parameters throughout run



Inlet/outlet port for direct connection to the dose filter holder and nebuliser, spacer or VHC



BRS 100i: User Interface



Setting a test parameter

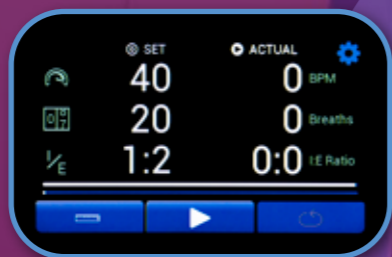

Set v Actual test parameters (before test run)



Set v Actual test parameters (during test run, with test progress bar and enhanced visualisation of breath status)

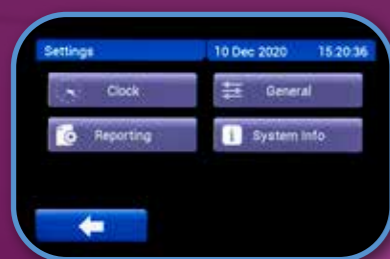

Settings menu

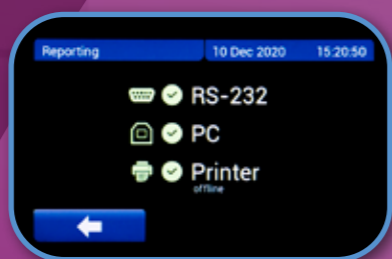

BRS 100i connectivity options

COPLEY

BRS 100i: Technical Specifications

Volume	0 to 800 mL (manually adjust)
Frequency	12 - 40 bpm
I:E Ratio	1:1, 1:2 or 1:3
Cycle Number	1 - 9,999 breaths
Waveforms	Sinusoidal
Start	Select start on inhalation or exhalation stroke
User Interface	5 inch, resistive colour touchscreen
Dimensions (w x d x h)	460 x 385 x 290 mm
Connectivity	RS-232 RUN - IN - for MDI Actuation Sensor or Footswitch USB A (for connection with a USB printer) USB B (for connection with a PC)



The BRS 100i is compatible with Inhalytix+, enabling instrument metadata and operational parameters to be linked directly to APSD measurement records for improved traceability. See page 218 for more information.

BRS 100i Accessories



Angle Adapter

Used to angle the device to a position representative of *in vivo* usage.



Label Printer

The Label Printer offers space-efficient printing for laboratories, with easy setup, intuitive operation, and high-quality report output. Integrating seamlessly with compatible Copley products, the Label Printer prints critical test parameters on to adhesive labels; ideal for affixing directly into laboratory notebooks.

Reporting

Extensive data output options are available as standard, including direct reporting to a printer or PC.

Reported parameters

- Start with: Inhalation/Exhalation
- I:E Ratio
- Breath frequency (bpm)
- Number of breaths
 - Set
 - Actual



BRS Qualification Kit

Qualification & Maintenance

- Calibration certificate of compliance to Ph. Eur./USP provided as standard
- Comprehensive IQ/OQ documentation packages and toolkits available
- Qualification Kit available
- Extended Warranty available

Breathing Simulator BRS 100i

Cat. No.	Description
9231	Breathing Simulator Model BRS 100i
1014	BRS 100i Extended Warranty - 1 year
1015	BRS 100i Extended Warranty - 2 years

Accessories

8797	MDI Actuation Sensor
8791	Footswitch
9765	Label Printer
9719	Thermal Ink Transfer Labels
9725	Ribbon for Thermal Ink Transfer
9117	IQ/OQ Documentation for BRS 100i/200i/300i
9115	Qualification Kit for BRSi Series
9118	Re-calibration of Qualification Kit for BRSi Series
9108	BRS 100i Re-calibration Certificate
9104	Angle Adapter for Breath Simulator BRS 100i

Breathing Simulator BRS 200i



Ph. Eur. 2.9.44 compliant



USP <1601> and <1602> compliant



ISO 27427:2013 compliant



21 CFR Part 11 compliant



Stores and recalls methods



Touchscreen user interface



Extensive data output options



Improved accuracy for infant and neonate profile volume requirements

Key Features:

Compatible with Temperature and Relative Humidity Sensor for measurement of environmental test conditions

2 x piston/cylinder arrangement driven by motor with accurate speed and position control

Compatible with MDI Actuation Sensor and Footswitch for coordinated testing

Quick-Release Connectors included as standard

For inhalation-only profiles, the exhaust port diverts air directly out of the exhaust, instead of back through the device

Inlet/outlet port for connection to the DUSA, Filter Holder and Mixing Inlet

Intuitive 10.1 inch touchscreen control with icon-based menu structure simplifies operation and clearly displays test parameters throughout run

Easily import/export methods and reports



For VHCs, simulate uncoordinated product use by starting the breathing profile on the exhalation portion of the profile.

BRS 200i: User Management

The user management feature of the BRS 200i helps ensure data remains compliant with 21 CFR Part 11. Take control of your data and grant appropriate levels of access to users:

Access Level	Permissions
1	Run approved methods
2	Run methods pending approval, and approved methods
3	Configure methods, run approved and pending methods
4	Approve methods
5	Assign user roles, modify system administration settings
6	Unrestricted access to all functions



User login screen



Assigning user access level

With password-protected user logins, each test run is date and time stamped and attributable to that user, providing a clear audit trail.

BRS 200i: Method Management

The BRS 200i offers users a number of different ways to define their chosen breathing patterns:

Choose from one of the pre-set methods

Configure their own

Import a defined breath pattern from an external source

BRS 200i: User Interface

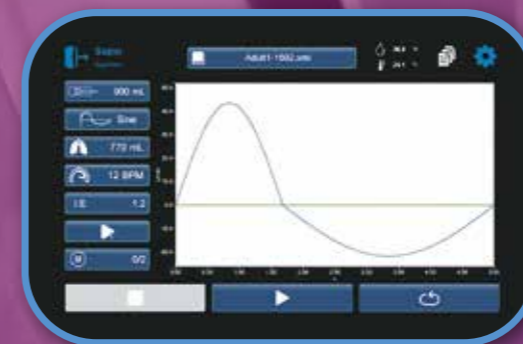

Main run test screen (ready to test)

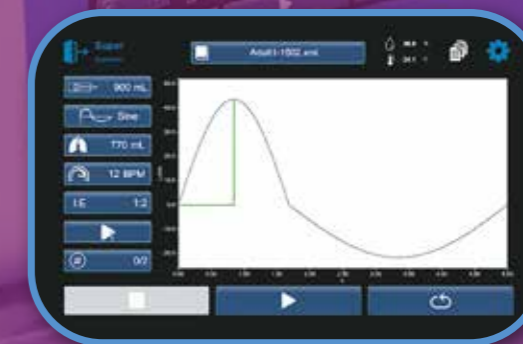

Main run test screen (test in progress)



Volume/piston selection



Settings menu

BRS 200i: Technical Specifications

Volume	2 cylinders, 2 volumes: 0 - 155 mL, 0 - 900 mL
Frequency	6 - 60 bpm
I:E Ratio	Variable
Waveforms	Sinusoidal, square, triangular, user-defined (flow vs time)
Profiles	Inhalation and/or exhalation
Start	Start on inhalation or exhalation stroke
User Interface	10.1 inch, capacitive colour touchscreen
Connectivity	RS-232 3 x USB A (for import/export of methods and connection with a USB keyboard or mouse) Ethernet - for computer networking Temperature/Humidity Sensor port RUN IN - for MDI Actuation Sensor or Footswitch RUN OUT - to trigger activation of other connected electronic devices



The BRS 200i is compatible with Inhalytix+, enabling instrument metadata and operational parameters to be linked directly to APSD measurement records for improved traceability. See page 218 for more information.

BRS 200i Accessories



EnviroMate™ Environmental Control Chamber

Changes in ambient temperature and/or relative humidity have been identified as variables that could impact nebuliser performance. The BRS 200i easily interfaces with EnviroMate for comprehensive environmental condition control.

See page 196 for further information.

NGI Cooler™ Stand for BRS 200i

Supports interfacing of the NGI Cooler with the BRS 200i, whilst saving precious benchtop space.

See page 202 for further information.

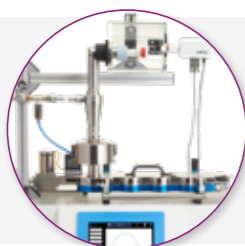

Real-Time Breath Verification Chamber BVC

Enables measurement and recording of the breathing profile generated during the test with the inhaler in place, using the Breath Profile Analyser BPA available in the Qualification Kit for BRSi Series (Cat. No. 9115). For use with the USP Induction Port only.

Reporting

Extensive data output options are available as standard, including direct reporting to a PC and export to a USB memory stick.

3 standard reports are available; Method Report, Run Report and Audit Report.

1) Method Report and 2) Run Report both report the following parameters:

- Waveform
- Volume (mL)
- Frequency (bpm)
- I:E Ratio
- Start Delay (s)
- Inhalation Duration (s)
- Inhalation Delay (s)
- Exhalation Duration (s)
- Exhalation Delay (s)
- Start with: Inhalation/Exhalation
- Cycles
- Cycle Duration (s)
- Test Duration (s)
- Max. Flow (L/Min)
- Max. Acceleration (L/Min/Min)
- Cylinder Size (mL)
- Method creation information (e.g. Status, Last Modified By) - Method Report only
- Last Run by (e.g. User, Last Run Date) - Run Report only

3) Audit report

All data changes reported with a date and time stamp attributable per user.

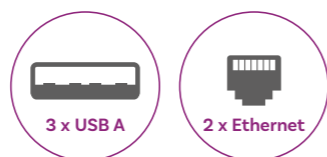

Qualification & Maintenance

- Calibration certificate of compliance to Ph. Eur./USP provided as standard
- Comprehensive IQ/OQ documentation packages and toolkits available
- Qualification Kit available
- Extended Warranty available

Breathing Simulator: BRS 200i

Cat. No.	Description
9176	Breathing Simulator Model BRS 200i
1016	BRS 200i/300i Extended Warranty - 1 year
1017	BRS 200i/300i Extended Warranty - 2 years

Accessories

8976	Temperature and Relative Humidity Sensor
8797	MDI Actuation Sensor
8791	Footswitch
9117	IQ/OQ Documentation for BRS 100i/200i/300i
9115	Qualification Kit for BRS 100i/200i/300i
9118	Re-calibration of Qualification Kit for BRSi Series
9119	BVC - Real-Time Breath Profile Verification Chamber

Breathing Simulator BRS 300i



Ph. Eur. 2.9.44 compliant



USP <1601> and <1602> compliant



ISO 27427:2013 compliant



21 CFR Part 11 compliant



Extensive data output options



Touchscreen user interface



Stores and recalls methods



Powerful drive system for generating challenging profiles

Key Features:

Compatible with Temperature and Relative Humidity Sensor for measurement of environmental test conditions

Piston/cylinder arrangement driven by motor with accurate speed and position control

Compatible with MDI Actuation Sensor and Footswitch for coordinated testing control

Quick-Release Connectors included as standard

For inhalation-only profiles, the exhaust port diverts air directly out of the exhaust, instead of back through the device

Inlet/outlet port for connection to the DUSA or Mixing Inlet

Intuitive 10.1 inch touchscreen control with icon-based menu structure simplifies operation and clearly displays test parameters throughout run

Easily import/export methods and reports



For VHCs, simulate uncoordinated product use by starting the breathing profile on the exhalation portion of the profile.

BRS 300i: User Management

The user management feature of the BRS 300i helps ensure data remains compliant with 21 CFR Part 11. Take control of your data and grant appropriate levels of access to users:

Access Level	Permissions
1	Run approved methods
2	Run methods pending approval, and approved methods
3	Configure methods, run approved and pending methods
4	Approve methods
5	Assign user roles, modify system administration settings
6	Unrestricted access to all functions



User login screen



Assigning user access level

With password-protected user logins, each test run is date and time stamped and attributable to that user, providing a clear audit trail.

BRS 300i: Method Management

The BRS 300i offers users a number of different ways to define their chosen breathing patterns:

Choose from one of the pre-set methods

Configure their own

Import a defined breath pattern from an external source

BRS 300i: User Interface



Main run test screen (ready to test)



Main run test screen (test in progress)



Settings menu

BRS 300i: Technical Specifications

Volume	0 - 5000 mL (500 - 5000 mL certified)
Frequency	6 - 60 bpm
I:E Ratio	Variable
Waveforms	Sinusoidal, square, triangular, user-defined (flow vs time)
Profiles	Inhalation and/or exhalation
Start	Start on inhalation or exhalation stroke
User Interface	10.1 inch, capacitive colour touchscreen
Connectivity	RS-232 3 x USB A (for import/export of methods and connection with a USB keyboard or mouse) Ethernet - for computer networking Temperature/Humidity Sensor port RUN IN - for MDI Actuation Sensor or Footswitch RUN OUT - to trigger activation of other connected electronic devices



The BRS 300i is compatible with Inhalytix+, enabling instrument metadata and operational parameters to be linked directly to APSD measurement records for improved traceability. See page 218 for more information.

BRS 300i Accessories

Real-Time Breath Verification Chamber BVC

Enables measurement and recording of the breathing profile generated during the test with the inhaler in place, using the Breath Profile Analyser BPA available in the Qualification Kit for BRSi Series (Cat. No. 9115). For use with the USP Induction Port only.

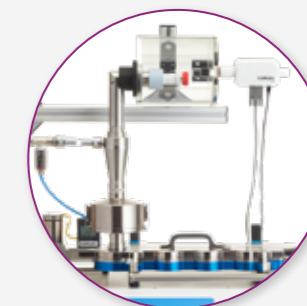

Reporting

Extensive data output options are available as standard, including direct reporting to a PC and export to a USB memory stick.

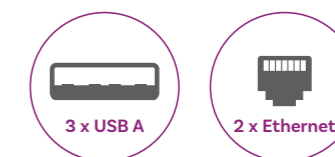

3 standard reports are available; Method Report, Run Report and Audit Report.

1) Method Report and 2) Run Report both report the following parameters:

- Waveform
- Volume (mL)
- Frequency (bpm)
- I:E Ratio
- Start Delay (s)
- Inhalation Duration (s)
- Inhalation Delay (s)
- Exhalation Duration (s)
- Exhalation Delay (s)
- Start with: Inhalation/Exhalation
- Cycles
- Cycle Duration (s)
- Test Duration (s)
- Max. Flow (L/Min)
- Max. Acceleration (L/Min/Min)
- Cylinder Size (mL)
- Method creation information (e.g. Status, Last Modified By) - Method Report only
- Last Run by (e.g. User, Last Run Date) - Run Report only

3) Audit report

All data changes reported with a date and time stamp attributable per user.

Qualification & Maintenance

- Calibration certificate provided as standard
- Comprehensive IQ/OQ documentation packages and toolkits available
- Qualification Kit available
- Extended Warranty available

Breathing Simulator BRS 300i

Cat. No.	Description
9186	Breathing Simulator Model BRS 300i
1016	BRS 200i/300i Extended Warranty - 1 year
1017	BRS 200i/300i Extended Warranty - 2 years

Accessories

8976	Temperature and Relative Humidity Sensor
8797	MDI Actuation Sensor
8791	Footswitch
9117	IQ/OQ Documentation for BRS 100i/200i/300i
9115	Qualification Kit for BRSi Series
9118	Re-calibration of Qualification Kit for BRSi Series
9119	BVC - Real-Time Breath Profile Verification Chamber

Ancillaries

Flow Controllers

Flow rate and volume of air control are crucial when it comes to the DDU testing and APSD measurement of OINDPs. The use of an appropriate flow controller is vital to comply with the regulatory requirements and streamline the testing, and when creating specific methods which are easy to follow and transfer as required.

The Ph. Eur. and USP require that test flow rate is controlled to within +/-5% of the specified value. This requirement can be met by selecting an appropriate flow control ancillary.

MDIs, MDIs with a Spacer/VHC, BAIs, Nebulisers, SMIs, Nasal Sprays & Nasal Aerosols

Regulatory requirements for these OINDPs call for the control of:

- Air flow rate - to a defined constant flow rate or to apply defined breathing profiles. See page 156.
- Total air volume.
- Delay/synchronisation to begin sampling at a defined time.

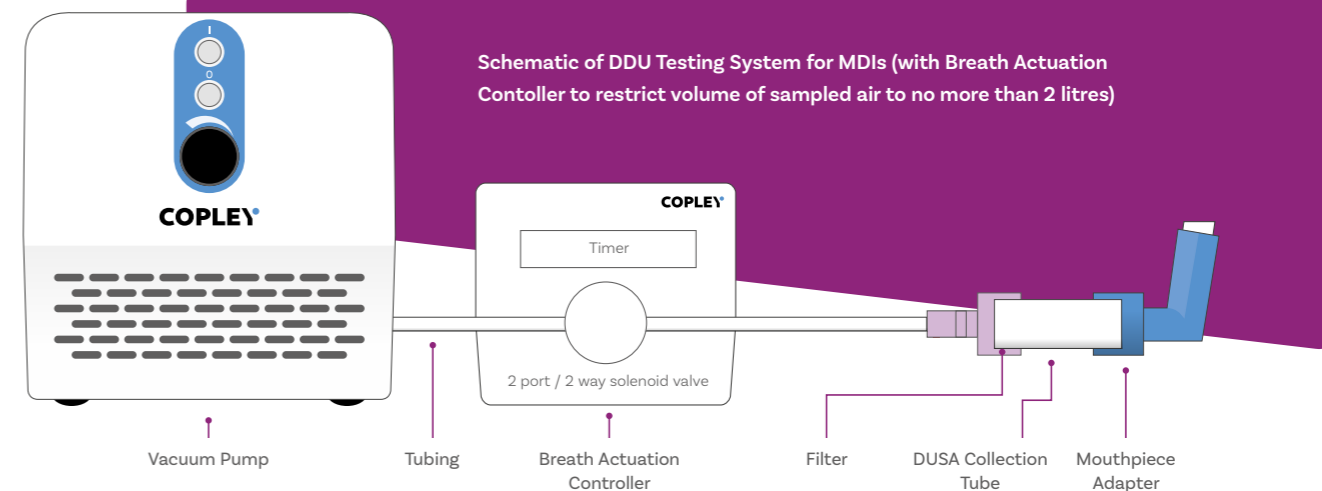

DPIs

In the case of DPIs, flow control is particularly important. Since most DPIs are classified as “passive” devices (i.e. they rely solely on the patient’s inspiration to operate), variations in flow rate can significantly affect device performance. It is therefore a regulatory requirement that critical flow conditions are applied during testing.

The testing of DPIs is further complicated by the fact that devices vary in terms of their resistance to flow i.e. some require more effort to inhale through than others.

Setting the flow rate for the testing of DPIs is more complex than for other types of OINDP. There are three variables which need to be established to determine the breath profile for DPI testing:

Flow Rate (Q)

Inspiration Volume

Critical Flow Control

1. Flow Rate (Q)

The *in vivo* strength and duration of the user’s inspiration is broadly replicated by the flow rate used and the duration of testing.

To establish the correct flow rate, the flow must first be adjusted to produce a pressure drop comparable with that found at the mouth of the user *in vivo* when using the particular inhaler being studied.

Both the Ph.Eur. and USP suggest a pressure drop over the inhaler of 4 kPa as broadly representative of the pressure drop generated during inhalation by patients using DPIs.

The pressure drop created by drawing air through an inhaler can be determined by measuring the absolute pressure downstream of the inhaler mouthpiece and comparing this directly with atmospheric pressure.

Using a flow control valve, it is then a simple matter to adjust the flow rate from the vacuum pump to produce the required pressure drop of 4 kPa and then, by replacing the inhaler with a suitable flow meter, to measure the flow rate, Q, required to produce this pressure drop.

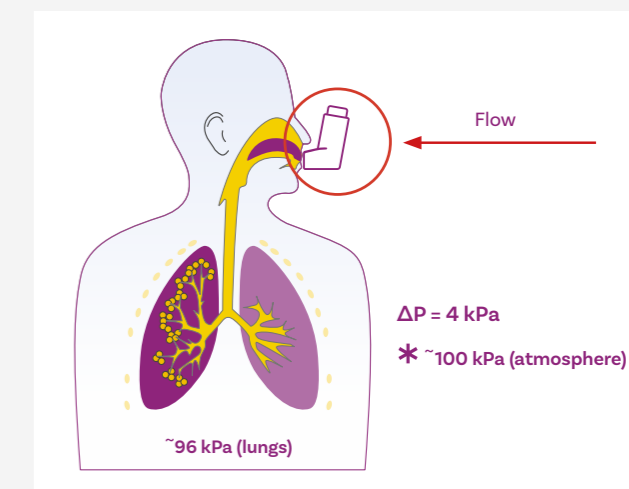

It is this Flow Rate Q, that the pharmacopoeias state should be used for DDU testing and APSD measurement.

The only exception to this criterion is that if the flow required to produce a 4 kPa pressure drop is >100 L/min, as for example in the case of particularly low resistance inhalers, then 100 L/min should be used.

2. Inspiration Volume

Once the flow rate (Q) has been established, it is now necessary to control the volume of air drawn through the inhaler during testing to the 2 or 4 litres per simulated inhalation required by the pharmacopoeias/regulators.

This is to simulate the *in vivo* inspiration volume of the patient and is achieved by introducing a timer-controlled, fast-acting solenoid valve between the test device and the vacuum pump.

TOP TIP

By using a timer to control the time that the solenoid valve is open, it is possible to control the volume of air drawn through the inhaler to achieve the volume specified.

TOP TIP

4 litres is considered to be the normal forced inhalation capacity of an average sized male weighing approx. 70 kg. In practice, it is not uncommon to widen the scope of the test parameters to cover a broader target patient population, such as geriatrics and paediatrics, as well as those already suffering from pulmonary problems, including typical use and unintentional misuse conditions.

Example Calculation

Volume: 4 litres (Ph. Eur)
 Flow Rate (Q): 100 L/min
Time = Volume * 60/Flow rate
 = 2.4 seconds

Volume: 4 litres (Ph. Eur)
 Flow Rate (Q): 60 L/min
Time = Volume * 60/Flow rate
 = 4 seconds

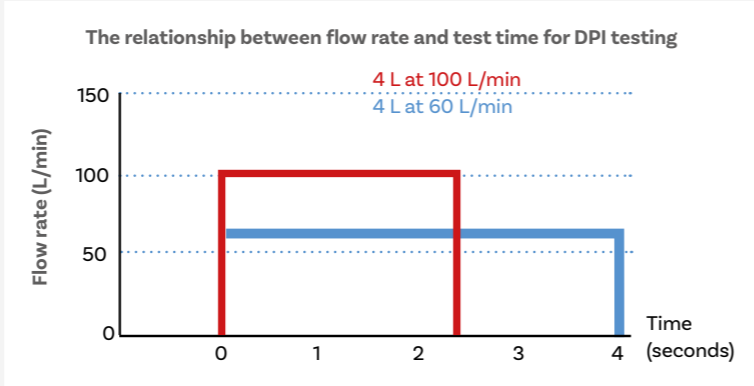

3. Critical Flow Control

Once the parameters to control the strength and duration of the simulated breathing cycle have been established, there is one final issue to be considered - flow rate stability.

Ensuring stable flow throughout the test is critical to the testing of DPIs, since, as passive devices, they can be sensitive to small changes in flow rate.

An easy way to validate flow rate stability is to ensure that critical (sonic) flow occurs in the flow control valve. This can be confirmed by simply measuring the absolute pressure at a point on either side of the valve.

Providing that the pressure downstream of the valve is less than half of the upstream pressure i.e. that the ratio $P3/P2 \leq 0.5$ then critical (sonic) flow is assured and the flow rate can be assumed to be stable.

Schematic of APSD Measurement System for DPIs

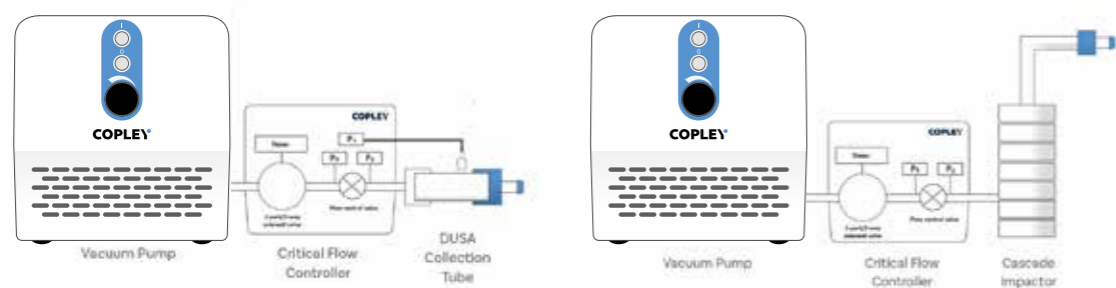

Conforming to the Ph. Eur. and USP specifications for a system that controls the key variables impacting the test conditions for DPIs (as described in the previous

section), our Flow Controllers have become the industry-standard for both DDU and APSD applications.

Choose your Flow Controller



Device Type	BAC 100i-R	TPK 100i-R
MDI	Y	Y
MDI with Spacer/VHC	Y	Y
Breath-Actuated MDI	Y	Y
DPI	N	Y
Nebuliser	Y	Y
SMI	Y	Y
Nasal Spray	Y	Y
Nasal Aerosol	Y	Y
Nasal Powder	N	Y



Breath Actuation Controller BAC 100i



Ph. Eur. and USP compliant



Simplified workflow with user-guided test set-up



Integrated timer for control of solenoid valve

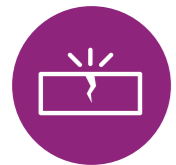

Fully automated *In situ* impactor leak testing



Extensive data output options



Intuitive touchscreen control



Spacer/VHC testing delay function

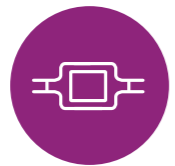

Inlet/In-line flow meter modes



Atmospheric pressure measurement

Key Features:



Quick-Release Connectors included as standard



Automatic calculation of test duration from volume and flow rate

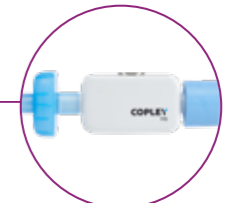

Interfaces with the Flow Rate Sensor FRS and DFM 2000 for flow rate measurement. See page 184



USB printer port interface for report output



Intuitive touchscreen user interface



Compact unit footprint



Hot-pluggable



BAC 100i-R and BAC 100i



TOP TIP

BAC 100i v BAC 100i-R

Two versions of the unit are available. The BAC 100i-R (Reversed) is functionally identical to the BAC 100i but the position of the pneumatic connections are reversed to improve connectivity with other inhaler testing equipment.

BAC 100i: User Interface



Guided test set up process

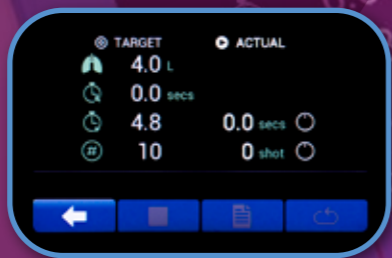

Target v Actual test parameters (before test run)

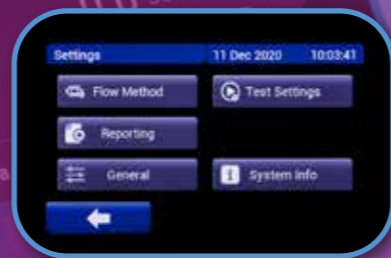

Settings menu



Leak test screen



Flow method screen



Easy setting of delay time

BAC 100i: Technical Specifications

User Interface	Resistive touchscreen
Flow Setting	Manual
Temperature/Relative Humidity Measurement Capabilities	Yes (see page 179)
Auto-Trigger	MDI Actuation Sensor Footswitch
Critical Flow Control	No
Solenoid Valve Opening/Closing Time	25/25 ms
Timer Range	0-600.0s resolution 0.1s
Dimensions (w x d x h)	415 x 315 x 250 mm

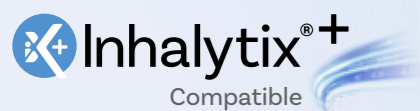

The BAC 100i series is compatible with Inhaler+, enabling instrument metadata and operational parameters to be linked directly to APSD measurement records for improved traceability. See page 218 for more information.

BAC 100i: Accessories

MDI Actuation Sensor

Enabling precise synchronisation of the MDI actuation with the onset of flow, the MDI Actuation Sensor simply clips on to most commercially available MDI canisters and connects directly to the BAC 100i.

Alternatively, a Footswitch can be used to synchronise the actuation of MDIs, nebulisers, SMIs and nasal aerosols with the onset of flow.

The MDI Actuation Sensor can also be used for the testing of MDIs with a spacer/ VHC in accordance with the specifications laid down in USP Chapter <1602>.



Temperature and Relative Humidity Sensor

The Temperature and Relative Humidity Sensor is designed to provide analysts with accurate data about environmental conditions.

Label Printer

The Label Printer offers space-efficient printing for laboratories, with easy setup, intuitive operation, and high-quality report output. Integrating seamlessly with compatible Copley products, the Label Printer prints critical test parameters on to adhesive labels; ideal for affixing directly into laboratory notebooks.



Reporting

Extensive data output options are available as standard, including direct reporting to a printer or PC.

Available reports:

- Run test
- Test setup
- Leak test
- Calibration



Breath Actuation Controller BAC 100i

Cat. No.	Description
8975	Breath Actuation Controller Model BAC 100i
8975-R	Breath Actuation Controller Model BAC 100i-R (Inlet Outlet Reversed)
1020	BAC 100i/R Extended Warranty - 1 year
1021	BAC 100i/R Extended Warranty - 2 years

Accessories

8976	Temperature and Relative Humidity Sensor
8797	MDI Actuation Sensor
8791	Footswitch
9765	Label Printer
9719	Thermal Ink Transfer Labels
9725	Ribbon for Thermal Ink Transfer
8983	BAC 100i Re-calibration Certificate
8752	Flow Time Verification Kit
8753	Re-calibration of Flow Time Verification Kit

Qualification & Maintenance

- Certificate of compliance to Ph. Eur./USP provided as standard.
- Comprehensive IQ/OQ documentation packages and toolkits available.
- Extended warranty available



Critical Flow Controller TPK 100i



Ph. Eur. and USP compliant



Simplified workflow with user-guided test set-up



User warned if sonic flow conditions are not met

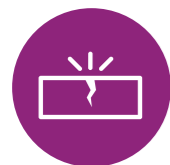

Fully automated *In situ* impactor leak testing



Extensive data output options



'Fly-by-wire' flow control valve - operation can be automated for more efficient and reproducible data

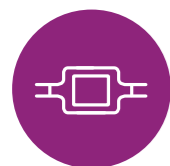

In-line flow measurement accommodated



Intuitive touchscreen control

Key Features:



The TPK can also be used as a Breath Actuation Controller (BAC) for testing MDIs with a spacer/VHC and BAI in accordance with Ph.Eur. 0671 and USP Chapter <1602>.



Quick-Release Connectors included as standard



Automatic calculation of test duration from volume and flow rate



USB printer port interface for report output



Intuitive touchscreen user interface



Compact unit footprint



Hot-pluggable

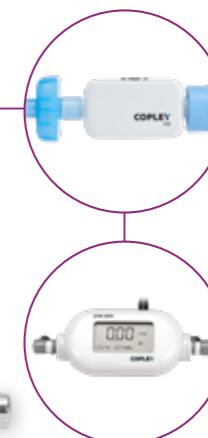

Interfaces with the Flow Rate Sensor FRS and DFM 2000 for flow rate measurement. See page 184



TPK 100i v TPK 100i-R

Two versions of the unit are available. The TPK 100i-R (Reversed) is functionally identical to the TPK 100i but the position of the pneumatic connections are reversed to improve connectivity between the TPK and other inhaler testing equipment.



TPK 100i-R and TPK 100i

TPK 100i: User Interface



Guided test set up process



Test set-up report



Target v Actual test parameters (before test run)



Leak test screen



Device resistance measurement

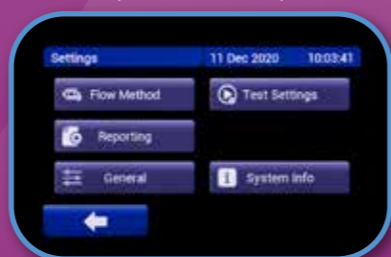

Settings menu



Guided calibration process



Flow method screen

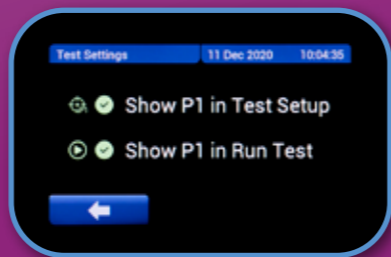

Test settings

TPK 100i: Technical Specifications

User Interface	Resistive touchscreen
Flow Setting	Manual and Automated
Temperature/Relative Humidity Measurement Capabilities	Yes (see page 183)
Auto-Trigger	Footswitch MDI Actuation Sensor
Critical Flow Control	Yes
Solenoid Valve Opening/Closing Time	25 ms / 25 ms
Timer Range	0-600.0s resolution 0.1s
Dimensions (w x d x h)	415 x 315 x 250 mm



The TPK 100i series is compatible with Inhalytix+, enabling instrument metadata and operational parameters to be linked directly to APSD measurement records for improved traceability. See page 218 for more information.

TPK 100i: Accessories

Temperature and Relative Humidity Sensor

The Temperature and Relative Humidity Sensor is designed to provide analysts with accurate data about environmental conditions.

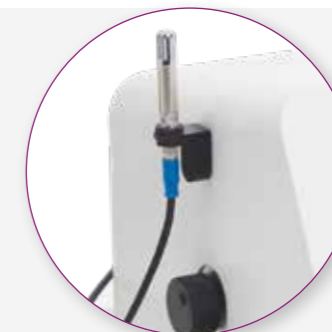

Footswitch

Enabling precise synchronisation of device actuation with the onset of flow, the Footswitch connects directly to the TPK 100i.

Alternatively, an MDI Actuation Sensor can be used for synchronisation of MDI actuation and the onset of flow.

Label Printer

The Label Printer offers space-efficient printing for laboratories, with easy setup, intuitive operation, and high-quality report output. Integrating seamlessly with compatible Copley products, the Label Printer prints critical test parameters on to adhesive labels; ideal for affixing directly into laboratory notebooks.



Reporting

Extensive data output options are available as standard, including direct reporting to a printer or PC.

Available reports:

- Run test
- Test setup
- Leak test
- Flow resistance
- Calibration



Critical Flow Controller TPK 100i

Cat. No.	Description
8970	Critical Flow Controller Model TPK 100i
8970-R	Critical Flow Controller Model TPK 100i-R (Inlet/Outlet Reversed)
1018	TPK 100i/R Extended Warranty - 1 year
1019	TPK 100i/R Extended Warranty - 2 years

Accessories

8976	Temperature and Relative Humidity Sensor
8791	Footswitch
8797	MDI Actuation Sensor
9765	Label Printer
9719	Thermal Ink Transfer Labels
9725	Ribbon for Thermal Ink Transfer
8973	TPK 100i Re-calibration Certificate
8752	Flow Time Verification Kit
8753	Re-calibration of Flow Time Verification Kit

Qualification & Maintenance

- Certificate of compliance to Ph. Eur./USP provided as standard.
- Comprehensive IQ/OQ documentation packages and toolkits available.
- Extended warranty available

Ancillaries

Flow Rate Measurement

Air flow control is critical in the DDU and APSD testing of OINDPs. For many inhaled products, air flow triggers or drives aerosolisation of the formulation and it can therefore have a significant effect on both delivered dose and APSD. Equally importantly, air flow impacts the performance of the test apparatus, notably cascade impactors which are designed to function at a constant air flow rate.

In addition, for some devices, especially DPIs, the air flow through the device provides the motive force for dose delivery; indeed, some breath-actuated/operated devices trigger only when the flow rate through them exceeds a certain value.

DDU Testing

A constant, repeatable flow rate is required throughout testing to ensure conformance with the regulatory requirements and pharmacopoeial specifications.

APSD Measurement

Air flow rate has a direct influence on the aerodynamic performance of cascade impactors. The jet-to-plate distances on most commonly used impactors are fixed. Therefore, as long as the nozzle diameters remain within defined tolerances and there are no leaks in the system, the cutoff diameter of any given stage is directly related to the volumetric flow rate of air passing through it. A change in flow rate results in a change in the aerodynamic particle size characteristics of the stage or stages concerned altering the measured APSD.

Determining Test Flow Rate

Although patient inspiration subjects inhalers to varying flow rates, DDU testing and APSD measurement require a constant volumetric air flow. Within this constraint, flow rates are specified, as far as possible, to reflect the conditions of use. Because of the link between air flow rate and cascade impactor performance, flow meters for OINDP testing must:

1. Be capable of measuring volumetric flow (L/min)
2. Be calibrated for exit flow as opposed to inlet flow



The pharmacopoeias specify that test flow rate should lie within +/-5% of the specified value.

We offer two flow meters that meet these criteria.

Choose your Flow Rate Measurement Device



Application	Flow Rate Sensor FRS	Flow Meter DFM 2000
Pharmacopoeial	Y	Y
IVVC	Y	Y
Inlet Flow	Y	Y
In-line Flow	Y	Y
Bi-directional Flow	Y	N

Flow Rate Sensor FRS

Key Features:



FRS in Holder of Inhaler Testing Workstation™ ITW



- Volumetric Mode:** Calculation of flow rate based on live temperature/pressure conditions
- Standard Mode:** Calculation of flow rate based on pre-set temperature/pressure conditions
- Fast data output, ideal for understanding changes in flow rate, such as rise-times
- Low flow resistance

Technical Specifications

Operation principle	Thermal (MEMS)
Flow Rate Range	- 200 to + 200 Std L/min
Resolution	0.1 StdL/min
Accuracy	Typically +/-1.75% of reading Maximum +/-2.5% of reading or ± 0.2 Std L/min, whichever is greater
Flow Resistance	< 4 kPa at 200 Std L/min
Volumetric Flow Calculation	Accurate calculation from in-built temperature and pressure sensors
Inlet Filter	Required (one supplied, replacements available)
Connectivity	Interface to external devices, such as: - Breath Actuation Controller BAC 100i/-R - Critical Flow Controller TPK 100i/-R - PC
Response Time	1 ms
Reporting	Flow rate and calibration data via RS-232 and USB
Calibration	Factory calibrations only
Power	5V DC, mains power supply provided with the FRS

The FRS is compatible with the following versions of Breath Actuation Controller and Critical Flow Controller: BAC 100i/BAC 100i-R, firmware v1.2.0 and above. TPK 100i/TPK 100i-R, firmware v1.2.0 and above.

The FRS connects directly to a Flow Controller via an RS-232 connection. The inlet flow rate is displayed clearly on the flow controller screen.



Qualification & Maintenance

- Calibration certificate of compliance to Ph. Eur./USP provided as standard

Flow Rate Sensor FRS

Cat. No.	Description
8100	Flow Rate Sensor Model FRS
8105	Inline Adapter Kit for FRS
8139	ITW Holder for FRS
8106	Pack of 12 Inlet Filters for FRS
8110	Re-calibration Certificate for FRS
5239	FRS Flow Meter Adapter for Induction Port, DUSA, WSC2, Filter Holder and Child Alberta Idealised Throat
8517	FRS Flow Meter Adapter for Adult Alberta Idealised Throat
8547	FRS to Alberta Idealised Nasal Inlet
8920	FRS Flow Meter Adapter for Glass Twin Impinger and FP Induction Port

Flow Meter DFM 2000

Key Features:

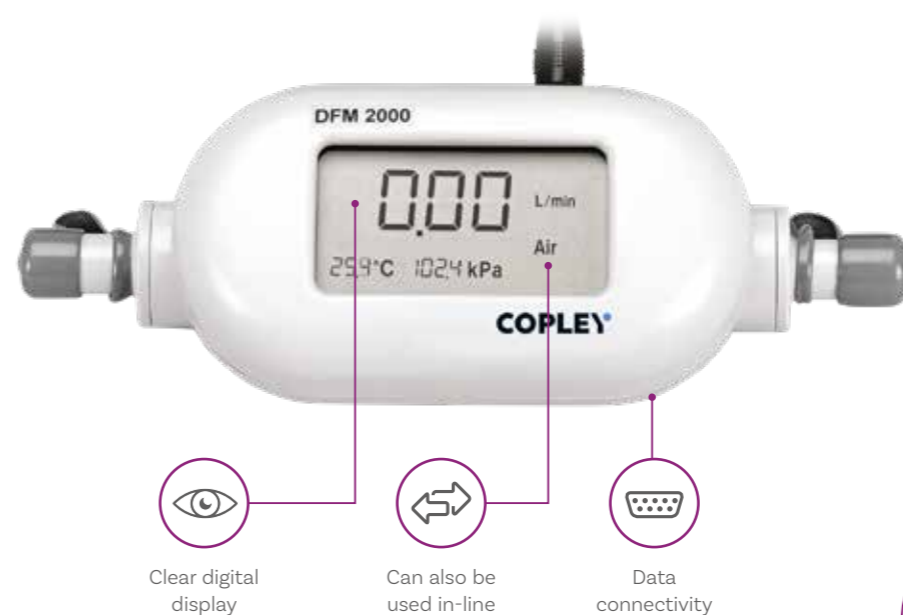

- Volumetric Mode:** Calculation of flow rate based on live temperature/pressure conditions
- Portable, hand-held device
- Standard Mode:** Calculation of flow rate based on preset temperature/pressure conditions



DFM 2000 in Holder of Inhaler Testing Workstation™ ITW

Technical Specifications

Operation Principle	Hot Wire Mass Flow
Flow Rate Range	0 - 200 Std L/min
Resolution	0.1 L/min between 90 and 200 L/min
Accuracy	+/-2% of reading
Flow Resistance	~ 8 kPa at 200 Std L/min
Volumetric Flow Calculation	Accurate calculation from in-built temperature and pressure sensors
Inlet Filter	Inlet filter required
Connectivity	Interface to external devices, such as - Breath Actuation Controller BAC 100i/-R - Critical Flow Controller TPK 100i/-R
Response Time	< 4ms. 63% of final value at full scale flow
Reporting	Flow rate & calibrate date via RS-232
Calibration	Factory calibrations only

Qualification & Maintenance

- Calibration certificate of compliance to Ph. Eur./USP provided as standard

Flow Meter DFM 2000

Cat. No.	Description
8764	Flow Meter Model DFM 2000

Accessories

5238	DFM Flow Meter Adapter
8765	Re-calibration Certificate for DFM 2000

COPLEY





Ancillaries

Vacuum Pumps

We offer vacuum pumps specifically designed for use in the testing of MDIs, DPIs, nebulisers and nasal products in accordance with the specifications laid down in the Ph. Eur. and USP.



Choose your Vacuum Pump

					
	Application	Low Capacity Pump LCP7	High Capacity Pump HCP7	2 x HCP7	Super Capacity Pump SCP7
	MDI	Y	Y	Y	Y
	MDI with Spacer/VHC	Y	Y	Y	Y
	DPI sonic flow with NGI @ > 80 L/Min	N	N	Y	Y
	DPI sonic flow with NGI @ < 80 L/Min	N	Y	Y	Y
	Nebuliser	Y	Y	Y	Y
	SMI	Y	Y	Y	Y
	Nasal Spray	Y	Y	Y	Y
	Nasal Aerosol	Y	Y	Y	Y
	Nasal Powder	N	Y	Y	Y

Low Capacity Pump LCP7

Key Features:

- Advanced cooling
- Quick-Release Connector included as standard
- Low maintenance
- Advanced sound insulation
- Oil-free
- Self-sealing compound carbon vanes continually adjust so that the pump effectively performs with "as new" efficiency throughout its service life.
- Left and right vacuum inlets - choose where to place pump in system
- Flow rate easily adjusted with dial
- Anti-vibration feet
- Small benchtop footprint

Technical Specifications

Type	Rotary Vane
Lubrication Type	Dry
Max. Flow (unrestricted)	133 L/min
Max. Sonic Flow through NGI	N/A
Max. Vacuum Level	<15 kPa
Applications: Nasal	Yes
Nebulisers	Yes
MDIs	Yes
DPIs	No
Dimensions (w x d x h)	300 x 360 x 300 mm
Weight	20kg

Qualification & Maintenance

- Included in IQ/OQ Documentation for Inhaler Testing Systems - see page 331
- Extended Warranty available

Low Capacity Pump LCP7

Cat. No.	Description
7933	Low Capacity Pump Model LCP7
1022	LCP7 Pump Extended Warranty - 1 year
1023	LCP7 Pump Extended Warranty - 2 years

Accessories

7904	Overhaul Kit for LCP7
------	-----------------------

High Capacity Pump HCP7

Key Features:

- Advanced cooling
- Quick-Release Connector included as standard
- Low maintenance
- Advanced sound insulation
- Oil-free
- Self-sealing compound carbon vanes continually adjust so that the pump effectively performs with "as new" efficiency throughout its service life.
- Left and right vacuum inlets - choose where to place pump in system
- Flow rate easily adjusted with dial
- Small benchtop footprint
- Left and right regulated and unregulated inlets

TOP TIP

Boost performance

Where the flow rate produced by the HCP7 is still not adequate, it is possible to connect a second HCP7 to the primary pump to give a maximum unregulated flow rate of up to 833 L/min, for example when testing DPIs under sonic flow conditions with the NGI, at high flow rates. Appropriate hose fittings are supplied with all HCP7 units to allow them to be operated in this way.

Technical Specifications

	1 x HCP7	2 x HCP7
Type	Rotary Vane	Rotary Vane
Lubrication Type	Dry	Dry
Max. Flow (unrestricted)	416 L/min	833 L/min
Max. Sonic Flow through NGI	80 L/min	100 L/min
Max. Vacuum Level	<15 kPa	<15 kPa
Applications: Nasal	Yes	Yes
Nebulisers	Yes	No
MDIs	Yes	No
DPIs	Yes	Yes
Dimensions (w x d x h)	300 x 580 x 400 mm	750 x 580 x 390 mm
Weight	45 kg	90 kg

Qualification & Maintenance

- Included in IQ/OQ Documentation for Inhaler Testing Systems - see page 331
- Extended Warranty available

High Capacity Pump HCP7

Cat. No.	Description
7931	High Capacity Pump Model HCP7
1024	HCP7 Pump Extended Warranty - 1 year
1025	HCP7 Pump Extended Warranty - 2 years

Accessories

7905	Overhaul Kit for HCP7
------	-----------------------

Super Capacity Pump SCP7

Key Features:

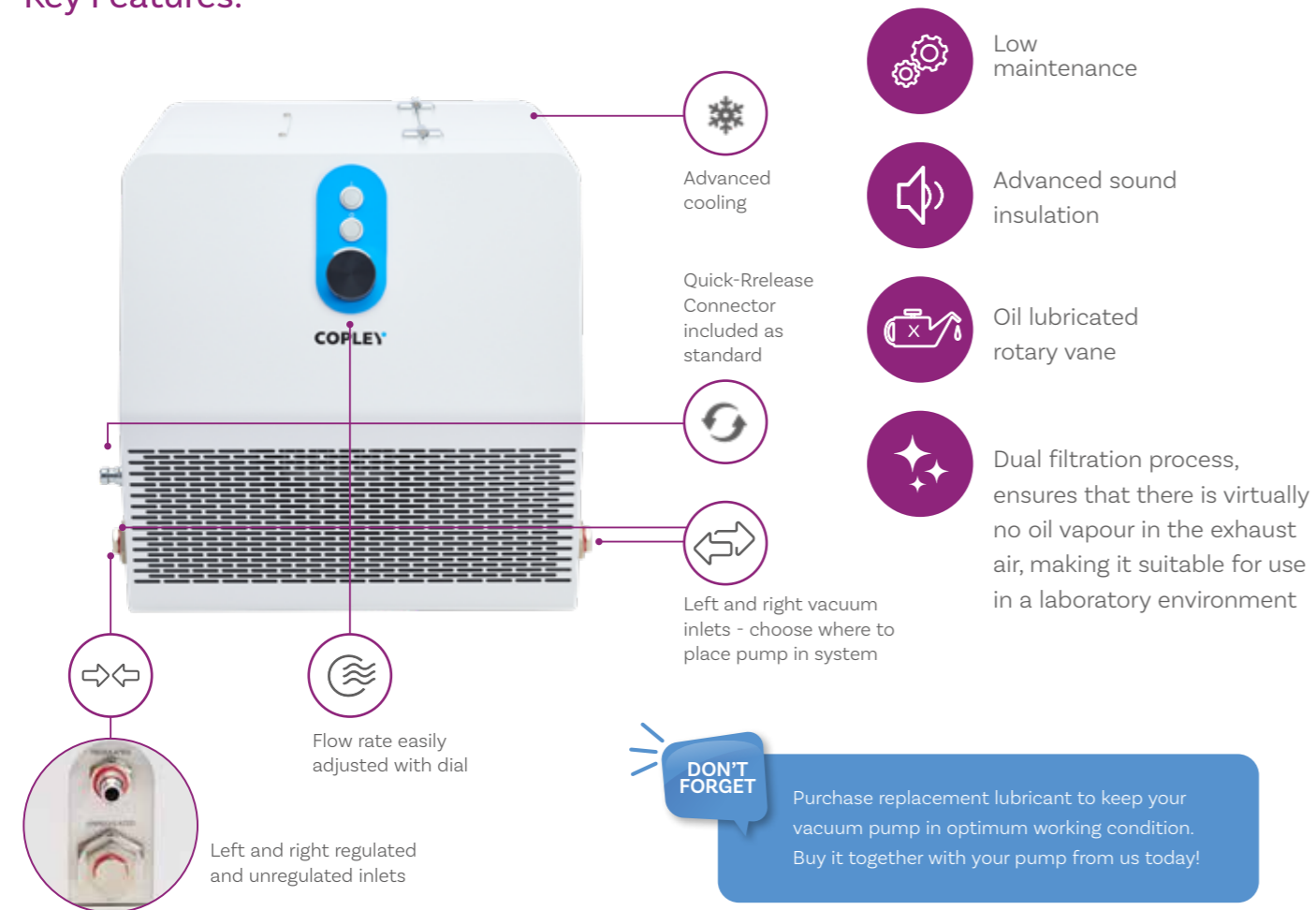

Advanced cooling

Quick-Release Connector included as standard

Low maintenance

Advanced sound insulation

Oil lubricated rotary vane

Dual filtration process, ensures that there is virtually no oil vapour in the exhaust air, making it suitable for use in a laboratory environment

Left and right vacuum inlets - choose where to place pump in system

Flow rate easily adjusted with dial

Left and right regulated and unregulated inlets

DON'T FORGET Purchase replacement lubricant to keep your vacuum pump in optimum working condition. Buy it together with your pump from us today!

Technical Specifications

Type	Rotary Vane
Lubrication Type	Oil
Max. Flow (unrestricted)	683 L/min
Max. Sonic Flow through NGI	100
Max. Vacuum Level	<0.1 kPa
Applications: Nasal	Yes
Nebulisers	Yes
MDIs	Yes
DPIs	Yes
Dimensions (w x d x h)	480 x 690 x 460 mm
Weight	65 kg

Qualification & Maintenance

- Included in IQ/OQ Documentation for Inhaler Testing Systems - see page 331
- Extended Warranty available

Super Capacity Pump SCP7

Cat. No.	Description
7938	Super Capacity Pump Model SCP7
1026	SCP7 Pump Extended Warranty - 1 year
1027	SCP7 Pump Extended Warranty - 2 years

Accessories

7909	Maintenance Kit for SCP7
7913	Replacement Lubricant (5 litres) and Funnel for SCP





Ancillaries

Environmental Control

Many factors have been identified that could give rise to variability in the testing of orally inhaled and nasal drug products (OINDPs). Each of these factors reduces the discriminatory power of tests to accurately determine product variability. Effective strategies to mitigate sources of variability in delivered dose uniformity (DDU) testing and aerodynamic particle size distribution (APSD) measurement have been the focus of rigorous investigation for many years. Environmental conditions is one key area.

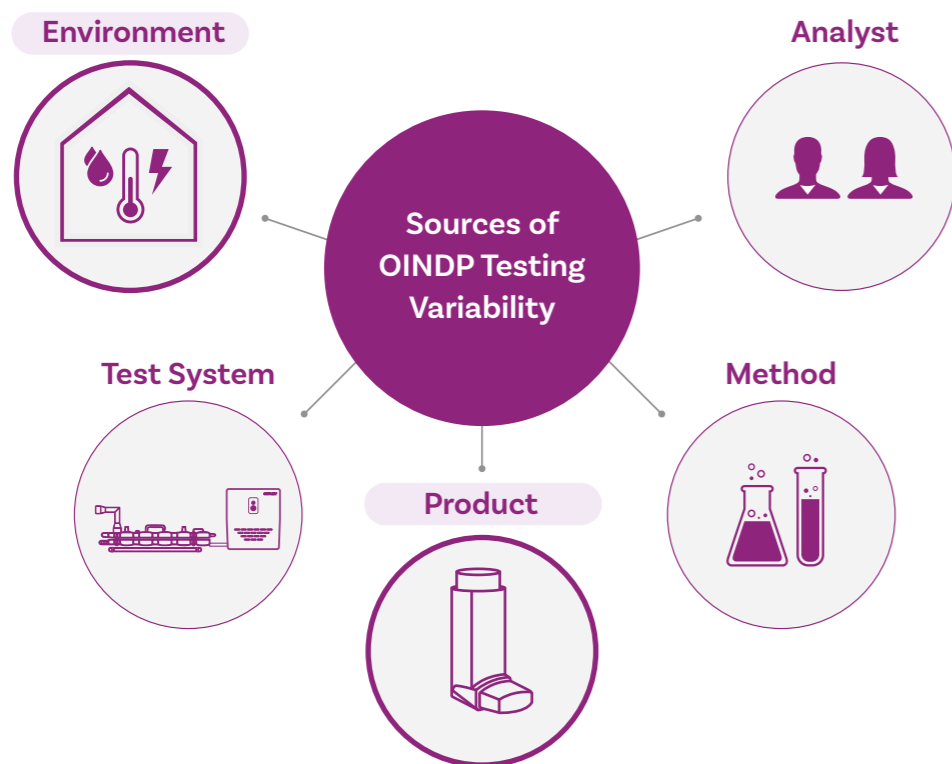

Localised changes in laboratory temperature and humidity, and also the presence of electrostatic charge, are known to have a direct influence on the dose emission and aerosol generation performance of OINDPs, thereby compromising DDU and APSD test data integrity.



TEMPERATURE

- Particle/droplet evaporation effects for MDIs, nebulisers, ADIs, nasal sprays and aerosols
- Accuracy of volumetric air flow rate measurements during testing



HUMIDITY

- Particle/droplet evaporation effects for MDIs, nebulisers, ADIs, nasal sprays and aerosols
- Water absorption effects for hygroscopic powder-based DPI formulations
- Electrostatic charge-related issues exacerbated by low humidity



ELECTROSTATIC CHARGE

- Device generated triboelectrification of particles (via drug, propellant, metering valve system, inhaler materials, packaging etc.)
- Analyst-induced electrostatic effects (via clothing, handling)

Use of proper control mechanisms

Ph. Eur. and USP specifically reference the control of environmental conditions in cases where temperature and/or humidity limits are stated on the product label and/or it is specified in the relevant monograph.

However, it is also good practice to implement environmental controls across all DDU and APSD testing applications to reduce variability and improve the accuracy, sensitivity and reproducibility of data.



EnviroMate

EnviroMate™

Inadequate control of environmental conditions can affect the dose emission and aerosol generation performance of OINDPs, leading to erroneous data and costly testing delays. EnviroMate is a cost-effective, compact, benchtop solution that addresses these issues with considerable value for scientists faced with:

- Variable laboratory conditions or inadequate climate control
- OINDPs with high sensitivity to temperature, humidity and/or electrostatic charge
- Poor reproducibility and unexplained out-of-specification (OOS) results
- Achieving better environmental control, in a cost-effective manner, without investing in a dedicated climatically-controlled laboratory for testing

Accommodating all types of dose uniformity sampling apparatus and cascade impactor, EnviroMate establishes and maintains uniform temperature and humidity throughout the chamber, whilst the built-in anti-static system helps minimise the unwanted effects of electrostatic charge.

Ideal for those struggling to achieve stable conditions for delivered dose uniformity (DDU) and aerodynamic particle size distribution (APSD) testing, EnviroMate provides users with consistent environmental control, in the immediate test area, enhancing data accuracy and repeatability.



Designed specifically for OINDP testing

Maintains uniform temperature and humidity throughout

Minimises electrostatic charge

As recommended in Ph. Eur. and USP

Compact, benchtop solution

No routine maintenance required

Energy efficient solution compared to dedicated environmental control rooms

Key Features:

- Sensitive temperature and relative humidity sensor ensures accurate performance
Adjacent holder for BAC 100i/TPK 100i Temperature and Relative Humidity Sensor included
- Anti-static system minimises electrostatic-induced variability
- Internal light maximises visibility
- Easy-to-remove water supply/waste reservoirs
- Temperature and relative humidity parameters are easily set and clearly visible to users
- Large, slot-sealed entry ports enable easy handling of test equipment
- A large, hinged door provides easy access
- Access ports and built-in quick-release connectors accommodate a wide range of ancillaries, such as flow controllers and vacuum pumps

EnviroMate™ Performance Data

EnviroMate has been specifically designed to accommodate a wide range of inhaler testing apparatus, including:

- Next Generation Impactor (NGI), Anderson Cascade Impactor (ACI), Multi-Stage Liquid Impinger (MSLI), Glass Twin Impinger (GTI)
- Inhaler Testing Workstation™ ITW with DUSA for MDIs and DPIs, SMIs and Nasal, Waste Shot Collector WSC2, Andersen Cascade Impactor (ACI) and Multi-Stage Liquid Impinger (MSLI)

EnviroMate can also interface with the BRS 200i and NGI Cooler™ for nebuliser testing, and flow controllers and vacuum pumps for testing of other OINDPs.

The graph opposite shows the performance envelope of the EnviroMate, with the shaded area defining the optimal performance range.

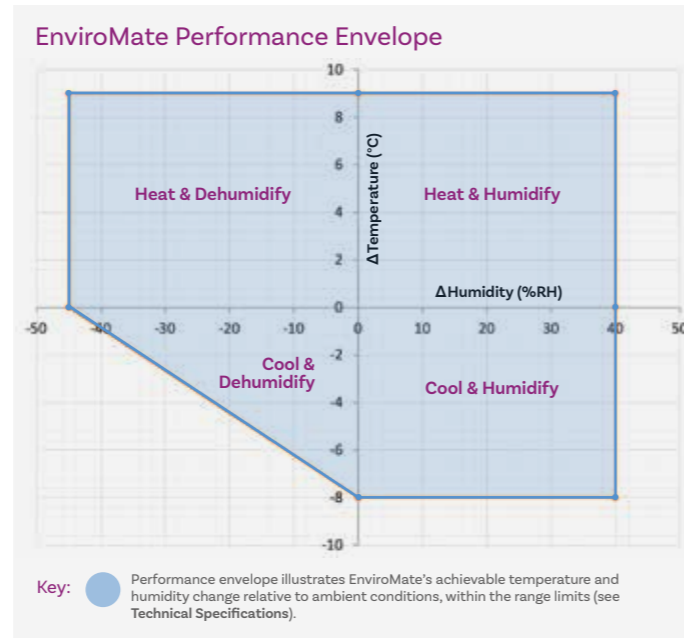

EnviroMate™ Technical Specifications

User Interface	Digital display with set-point control buttons
Ambient Temperature	16 - 28°C
Temperature Control Range	17 - 35°C
Temperature Control Accuracy	Typically ±2°C
Ambient Humidity	35 - 85% RH
Humidity Control Range	15 - 85% RH
Humidity Control Accuracy	Typically ±5% RH
Electrostatic Minimisation System	Included as standard
Ancillary Connector Ports	2 x ports for quick-release connectors (left and right) 2 x ports for cables (left and right) 2 x ports for interface with BRS 200i and NGI Cooler™ (right)
Sound Level	63 dBA at 1m
Power Supply	Mains supply: 230V, 50Hz or 115V, 60Hz
Compressed Air Supply Connector	SMC Series KQ2 6 mm O.D. One-touch Fitting
Compressed Air Supply Pressure	5 to 8 bar (G)
Capacity	280 litres
Unit Dimensions (w x d x h)	1258 x 761 x 890 mm



EnviroMate™

Cat. No.	Description
5040	EnviroMate Environmental Chamber
5042	IQ/OQ Documentation for EnviroMate
5043	Qualification Tools for EnviroMate
5044	Recalibration of EnviroMate Qualification Tools

We also offer additional tools to help mitigate the impact of localised environmental conditions on OINDP test data integrity:



Anti-Static Grounding Kit

Dissipating electrostatic charge build-up introduced during handling of the test apparatus, inhaler and other non-conductive items coming into contact with the laboratory bench during test preparation, the Anti-Static Grounding Kit safely grounds the analyst for effective static elimination. The Anti-Static Grounding

Kit contains:

- A comfortable and adjustable user wristband
- 1 x bench mat
- 1 x earth plug for grounding (UK, EU and US versions available)

Cat. No.	Description
9300	Antistatic Grounding Kit

Electrostatic Eliminator

Designed to effectively eliminate electrostatic charge over the lab bench area, the Electrostatic Eliminator is an efficient ioniser that is capable of neutralising static across a broad area, while still providing a comfortable working environment for analysts.

- Excellent coverage over a wide area (2 m x 0.6 m)
- Rapid electrostatic discharge
- Compact, benchtop unit



Cat. No.	Description
9301	Electrostatic Eliminator

Digital Static Meter

Ideal for measuring the intensity and polarity of electrostatic charge in the test area, the Digital Static Meter is an easy-to-use, handheld device ideal for quick checks of the electrostatic charge level around the equipment prior to testing, to facilitate optimal control.

- Compact and lightweight unit
- Measures electrostatic charge in the range 0 to ± 20 kV



Cat. No.	Description
9302	Digital Static Meter





Ancillaries

NGI Cooler™

Exacerbated evaporation caused by the thermal mass of the NGI may be an issue for devices such as nebulisers that deliver the drug as an aerosolised solution. Loss of solvent reduces droplet size, producing artificially low particle size measurements and compromises the integrity of APSD data.

The NGI Cooler is designed to support testing in a temperature-controlled environment, cooling the impactor to 5°C to overcome the issue of droplet size change due to evaporation.



Ph. Eur. and USP compliant



Quiet operation



Precise temperature control

Key Features:

- Built-in light for high visibility** (Eye icon)
- Easy access via large front and rear doors** (Checkmark icon)
- Double-glazed panels ensure high energy efficiency** (Thermometer icon)
- Additional space for cooling of other components, such as collection cups meaning multiple test can occur in quick succession** (Cup icon)
- Comfortably accommodates NGI in open or closed position** (Nebuliser icon)
- Twin side access ports for the nebuliser (and mixing inlet if used)** (Nebuliser icon)
- Benchtop unit** (Cuboid icon)

DON'T FORGET The NGI Cooler is also suitable for cooling the Andersen Cascade Impactor ACI too.

NGI Cooler Accessories

NGI Cooler Stand for BRS 200i

Supports interfacing of the NGI Cooler with the BRS 200i, whilst saving precious benchtop space.



NGI Cooler Shelf

Maintains an NGI at 5 °C during APSD measurement while simultaneously preparing a second cup tray, accessories or NGI for subsequent use.



Qualification & Maintenance

- Comprehensive IQ/OQ documentation packages and toolkits available
- Extended Warranty available

NGI Cooler™

Cat. No.	Description
5009	NGI Cooler
1046	NGI Cooler Extended Warranty - 1 year
1047	NGI Cooler Extended Warranty - 2 years

Accessories

9114	NGI Cooler Stand for BRS 200i
5024	NGI Cooler Shelf
5011	NGI Cooler Qualification Documentation
5012	NGI Cooler Qualification Tools
5013	Re-calibration of NGI Cooler Qualification Tools

NGI Cooler: Technical Specifications

Pharmacopoeial Compliance	Ph. Eur. 2.9.44 USP <1601> EPAG recommended
Temperature Range	0°C and ambient (typically 5°C to 10°C)
Temperature Accuracy	± 1.5°C
Dimensions (w x d x h)	1000 x 500 x 575 mm

Ancillaries

Inhaler Testing Workstation™ ITW

The hub of an inhaler testing system, the ITW is a modular workstation designed to aid handling and manipulation of the various pieces of test apparatus and accessories, improving workflow.

The ITW offers analysts the flexibility to pick and choose the attachments necessary for their test set-up needs. Simply connect the required attachments and start testing with greater ease.



Suitable for DDU testing and APSD measurement applications



Quick-slide attachments for rapid method change



Suitable for both right- and left-handed configurations



Flexible configurations to suit different testing requirements



Stable and secure platform for test components



Supplied with quick-release connectors for easy interfacing

ITW: DDU Testing

The ITW keeps the DUSA collection tube, vacuum connection, flow rate sensor and waste shot collector (WSC2) in place during the testing process.



Rotatable DUSA holder enables easy manipulation of the sampling apparatus



Quick-release connectors

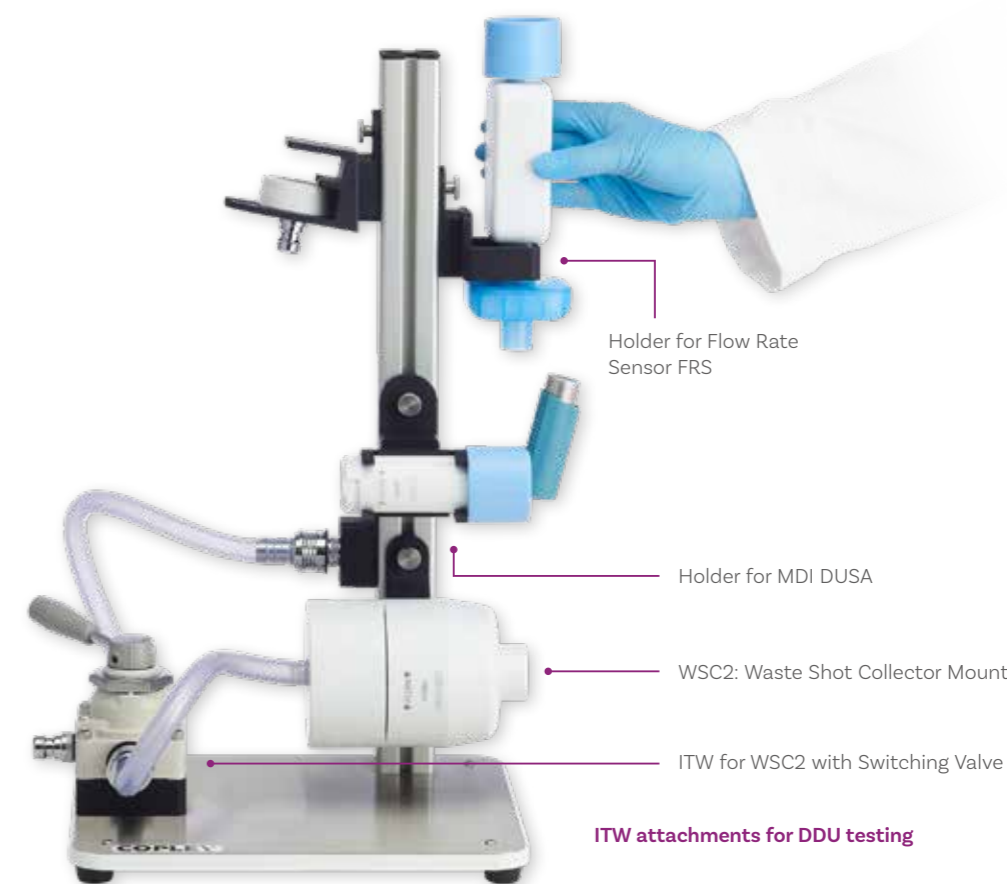

Holder for DUSA Filter Holder



Tubing attachments ensure the workstation remains organised



Dose sampling and waste collection for nasal drug products

ITW: APSD Measurement

The ITW provides a stable support for the impactor during testing, together with the flow rate measurement device.

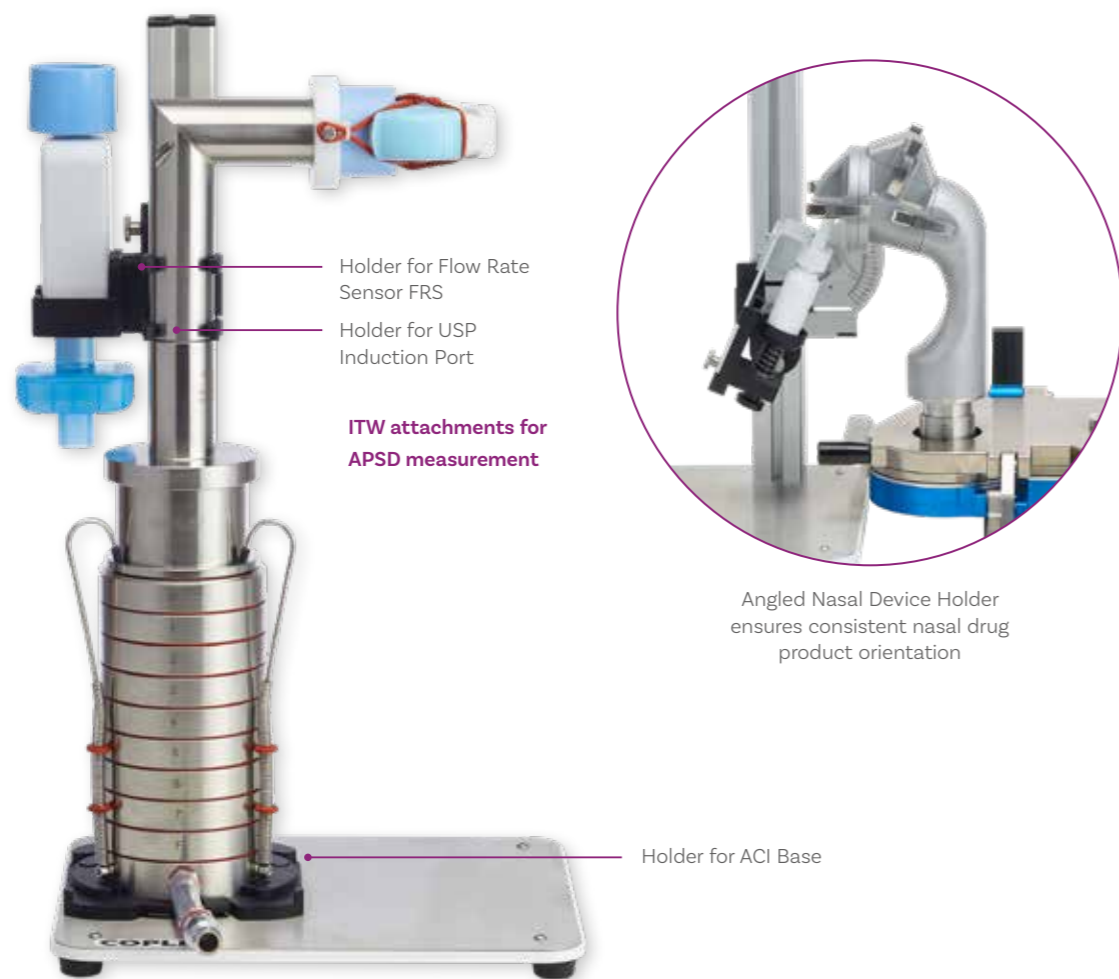

Spare/Additional Tubing



A variety of tubing is available to provide connections between the various components making up the inhaler testing system. The 3 mm tubing is designed to provide the connection between the DUSA for DPIs and Critical Flow Controller TPK.

Tubing

Cat. No.	Description
5015	10 mm i.d. PVC Tubing (per metre)
5016	16 mm i.d. Wire Reinforced PVC Tubing (per metre)
5017	3 mm i.d. PVC Tubing (per metre)

Quick-Release Connectors



Quick-Release Connectors are provided as standard with various pieces of equipment. Additional connectors can be purchased if required in two sizes, 13 mm and 16 mm designed for use with 10 mm i.d. and 16 mm i.d. tubing respectively.

Quick-Release Connectors

Cat. No.	Description
5026	13mm Quick-Release Connector - 3/8" threaded QR Male
5027	13mm Quick-Release Connector - 1/2" threaded QR Male
5028	16mm Quick-Release Connector - 3/8" threaded QR Male
5029	16mm Quick-Release Connector - 1/2" threaded QR Male

Also compatible with:



Multi-Stage Liquid Impinger (MSLI)



Fast Screening Andersen (FSA)

Inhaler Testing Workstation™ ITW

Cat. No.	Description
8120	Inhaler Testing Workstation - Baseplate and Upright
8125	Inhaler Testing Workstation for WSC2 with Switching Valve
8136	ITW Holder for ACI Base
8139	ITW Holder for FRS
8132	ITW Holder for DPI DUSA
8131	ITW Holder for MDI DUSA
8133	ITW Holder for MDI/DPI Filter Support Cap
8137	ITW Holder for USP Induction Port
8130	ITW QR Tube Holder
8143	ITW Nasal Device Holder

Ancillaries

Glass Expansion Chambers

The majority of nasal products are designed to generate droplets/particles with a mass median aerodynamic diameter (MMAD) of greater than 10 to 20 microns. This is to increase nasal deposition and minimise deposition in the lungs.

However, most sprays deliver a proportion (typically <5%) of fine droplets in the <10 micron range. It is important to quantify this dose since it can penetrate beyond the nasal tract and into the lower respiratory tract or lungs, which may be undesirable.

Cascade impactors are designed to capture particles in the range 0 to 10 microns and are widely used for this application.

Broad Characterisation of Nasal Drug Particle Deposition Within Respiratory System

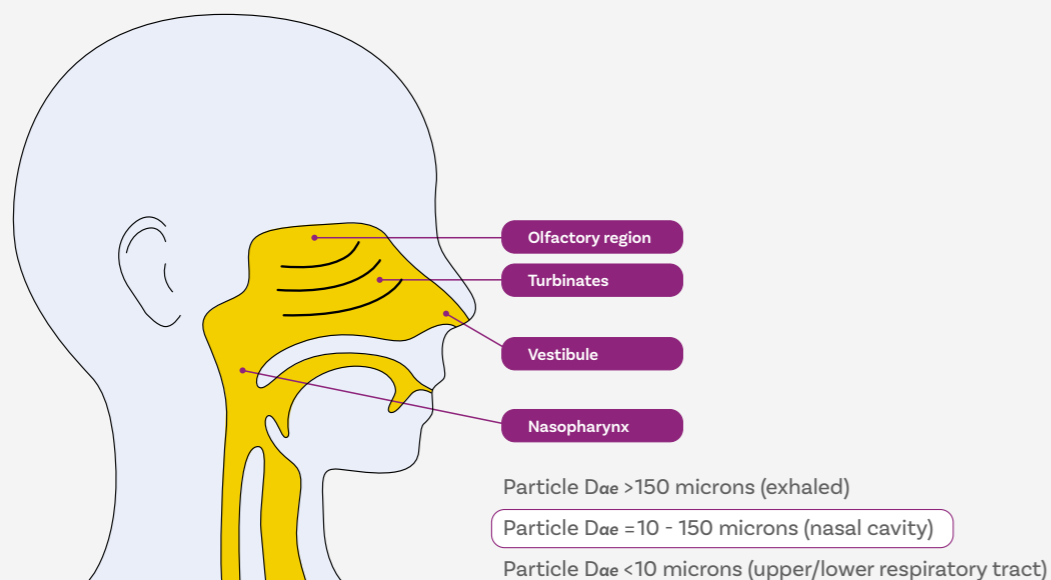

The use of a cascade impactor in conjunction with a high volume expansion chamber is used to measure the amount of drug in small particles or droplets in respect of nasal sprays and aerosols.

In accordance with the draft guidance, we offer a range of glass expansion chambers to meet these requirements.



FDA compliant



3 chamber sizes available



Certified volume



Special nosepiece adapters are available for the entry port to accommodate the different types of nasal devices

Key Features:



ACI and NGI adapters available for airtight connection between outlet port of expansion chamber and impactor

Representative testing: entry port at 30° to outlet port for insertion of nasal device

TOP TIP
After validation, it may be appropriate to use a reduced impactor stack (e.g. Stage 0 = >9 microns, Stage 2 = 4.7 to 9 microns, Stage F = 0.0 - 4.7 microns of an ACI at 28.3 L/min).

ACI with Glass Expansion Chamber

We offers three sizes:

1 L chamber: to maximise drug deposition below the top stage of the impactor (i.e. for nasal aerosols)

2 L chamber: to maximise aerosolisation and impactor deposition (i.e. for nasal sprays)

5 L chamber: for powerful nasal sprays where increased space is required to generate full plume

Glass Expansion Chamber Accessories

Benchtop Holder for Glass Expansion Chamber

For keeping benchtops tidy and glass expansion chambers safe.



Expansion Chamber to Flow Meter Adapter

For ensuring a proper interface between the Glass Expansion Chamber and flow meter when setting flow rate.

Glass Expansion Chambers

Cat. No.	Description
8950	1000 mL Glass Expansion Chamber
8951	2000 mL Glass Expansion Chamber
8952	5000 mL Glass Expansion Chamber
8953	Volume Verification Certificate for Expansion Chamber
8954	Adapter & Clamp for ACI/FSA*
5217	Adapter & Clamp for NGI/FSI*
8961	Set of 10 O-Rings for Expansion Chamber Adapter
5212	'Quick Clamp' for ACI
8955	Benchtop Holder for Glass Expansion Chamber

* Please specify Aluminium (A), 316 Stainless Steel (S) or Titanium (T) when placing your order.



Ancillaries

Kiel Nasal Inlet KNI

Developed in collaboration with Kiel University, the Kiel Nasal Inlet (KNI) is a purpose-designed sampling inlet and collection device for the *in vitro* assessment of nasal sprays, nasal aerosols and nasal powders.

The KNI enables vertical and near-vertical product actuation, while minimising splashback, drips and leakage. Its inlet design forms a secure seal with the device under test, while allowing airflow to pass through the emitted plume toward either a downstream collection filter or an impactor, enabling complete dose capture and accurate, reproducible testing of nasal drug products.

Delivered Dose Uniformity Testing

For delivered dose assessment, the KNI provides a secure interface with the nasal device under test, helping reduce the leakage and dripping commonly associated with vertical nasal actuation. Its vented design maintains a defined airflow through the emitted plume, supporting representative transfer of the dose to a downstream collection filter.

The KNI can be used with or without applied airflow, enabling laboratories to perform straightforward dose consistency testing or introduce controlled airflow conditions where required.



KNI with nasal spray



KNI for DDU dose collection

APSD Measurement

The KNI can be used as an inlet to impactor systems for the aerodynamic particle size assessment of nasal drug products.

Use of a standard induction port alone typically requires an airtight seal via an adapter and enforces a horizontal orientation, which does not reflect typical nasal product use. The KNI enables vertical actuation and provides a sealed interface with the device, to prevent leakage, while its vented design allows airflow to pass through the emitted plume as it enters the impactor.

When used with impactors such as the Fast Screening Andersen (FSA) or Fast Screening Impactor (FSI), the KNI delivers the emitted plume directly into the size fractionation stages without additional aerosol expansion, minimising losses and supporting optimal plume transfer into the impactor.



KNI with Fast Screening Impactor (FSI) for the assessment of drug in small particles



Supports EMA/FDA drug in small particles assessment



Compatible with Copley DUSA Tube Shaker DTS 100i



Solvent-resistant materials for reliable recovery



Precision-engineered and serialised for traceability



Flexible inlet for multiple device types

Further Reading

To learn more about the development and application of the KNI, read the paper authored by the team at Kiel University:

Advancing nasal formulation characterization: Considerations toward a robust and precise method to determine the mass fraction below 10 µm in nasal products. Aerosol Science and Technology, 58(11), 1305-1317.

Kiel Nasal Inlet KNI

Cat. No.	Description
8555	Kiel Nasal Inlet
8144	Kiel Nasal Inlet Holder for ITW



Ancillaries

Mouthpiece & Nosepiece Adapters

Ensure a proper seal is maintained between the device under test and the sampling apparatus with our range of Mouthpiece and Nosepiece Adapters.

Specially moulded from high quality silicone rubber to ensure superior performance, adapters are available for the more common devices on the market, or can be custom-made for your specific device type.

The adapters are generally transferable between different product test systems, however, there are cases where the inlet diameters may differ between apparatus. Please specify the intended testing system when ordering to ensure the correct size adapter is supplied.

Mouthpiece Adapters

Suffix the letter below to the Cat. No. for listed Mouthpiece Adapters, e.g. 5003C							
C	Easyhaler®	D	Cyclohaler®	E	Handihaler®	F	Diskus®
G	Novolizer®	H	Rotahaler®	I	Turbuhaler®	J	Diskhaler®
K	Respimat®	L	Evohaler®	M	Pari LC Plus®	N	Trudell AeroChamber®
O	Tobi Podhaler®	P	Ellipta®	Q	Rapihaler®	R	Nexthaler®
S	Qvar® Autohaler®	T	K-haler®	U	Airomir® Inhaler	V	PowdAir Plus®

Bespoke Design Available

For any device types not listed above, we offer a custom mouthpiece adapter design service. Simply supply a sample of the inhaler to be tested so that a 'cast' can be taken. This is used to create a moulding tool, which is used to make the mouthpiece adapter.

The tool is then supplied along with the mouthpiece adapter(s) to the user so that it can be reused should any additional mouthpiece adapters be required of that design, in the future.

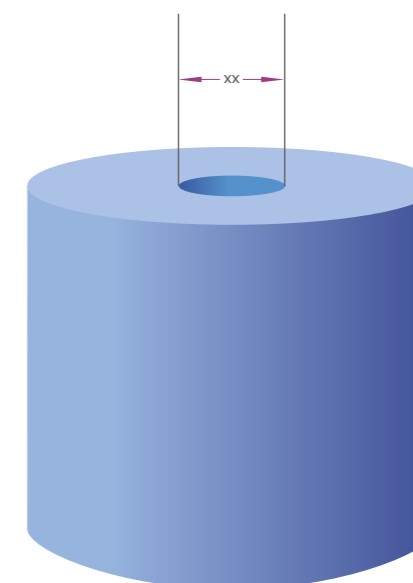

TOP TIP Standard adapter colour is light blue, but other colours are available on request.

Mouthpiece Adapter Accessories

Inhaler Support Accessory

For devices that require extra support, the Inhaler Support Accessory holds the device under test in the correct position throughout testing.



Mouthpiece Adapter Rack

To keep benchtops tidy and mouthpiece adapters organised.

Mouthpiece Adapters

Cat. No.	Description
5003	Custom Mouthpiece Adapter for Induction Port, DUSA, WSC2, Filter Holder and Child Alberta Idealised Throat
5004	Tooling Charge for Custom Mouthpiece Adapter
5237	Custom Mouthpiece Adapter for Glass Twin Impinger and FP Induction Port
8515	Custom Mouthpiece Adapter for Adult Alberta Idealised Throat and Albuterol SCA
9013	Custom Mouthpiece Adapter for PTT 1000

Accessories

Cat. No.	Description
8132	Inhaler Support Accessory
5003Y	Mouthpiece Adapter Engraving (per Mouthpiece Adapter)
5004	Tooling Charge for Custom Mouthpiece Adapter
5005	Mouthpiece Adapter Storage Rack
5022	Certificate of Conformance for Mouthpiece Adapter Material



AINI nosepiece adapter

Nosepiece Adapters

We offer nosepiece adapters that create a perfect fit between a nasal device and a DUSA, an induction port, and Glass Expansion Chambers.

A nosepiece adapter for the Alberta Idealised Nasal Inlet (AINI) is also available. Custom-built, the adapter creates an airtight seal between the AINI and test device enabling passive nasal devices to be used under air flow rate (predominantly single dose nasal powders).



Nasal Adapters

Cat. No.	Description
5006	Custom Nosepiece Adapter (for Ind Port and/or DUSA)
8544	Nasal Device Nosepiece Adapter for AINI
8957	Nasal Aerosol Nosepiece Adapter for Expansion Chamber Inlet
8958	Tooling Charge (per nasal aerosol device)
8959	Nasal Spray Nosepiece Adapter for Expansion Chamber Inlet
8960	Tooling Charge (per nasal spray device)
8956	Expansion Chamber to Flow Meter Adapter
5022	Certificate of Conformance for Nosepiece Adapter Material



Inhalytix®+

Connected Data Management

Generating accurate data is a critical requirement in OINDP testing. However, this process is frequently challenged by fragmented workflows and manual data handling. Analysts often need to enter data across multiple systems, validate spreadsheets, and track down essential test parameters and metadata. These factors contribute to inefficiencies, compliance risks, and increased potential for errors.

Inhalytix®+ addresses these challenges by providing a unified platform for the management and analysis of APSD data generated for all types of OINDPs. Test method parameters, equipment configurations and analytical results are managed within a single system, while integrated user management and audit trails support traceable data handling and clear attribution of analytical activities.

The platform supports both research and quality control environments, providing a central platform for data management, linking equipment configuration, analytical data and reporting within a single structured environment.

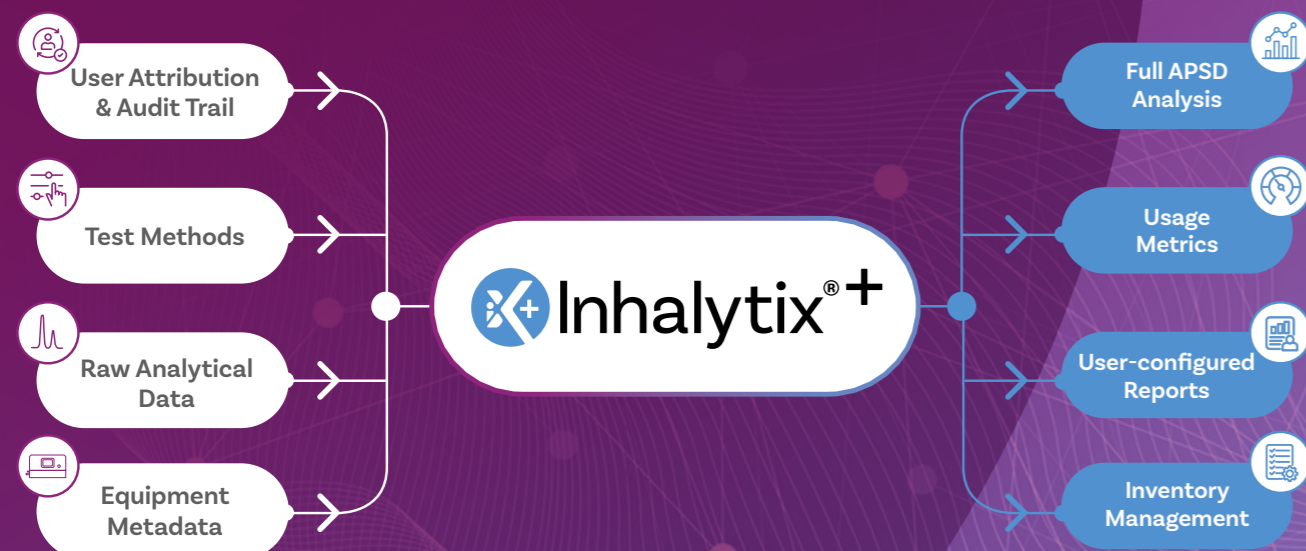

Traceable Data Management

Inhalytix®+ integrates data analysis with test method configuration, equipment management and reporting within a single platform. Method parameters, equipment configurations and associated metadata are stored within the system ensuring that the analytical conditions under which data are generated remain fully traceable throughout the workflow.

User access is managed through a role-based permission structure that allows administrators to define responsibilities and control access to software functions. All user actions are recorded within

comprehensive audit trails, providing clear attribution for data entry, modifications and approvals and ensuring that datasets remain fully traceable throughout the testing workflow.

The software automatically calculates commonly used performance metrics, including Fine Particle Dose (FPD), Fine Particle Fraction (FPF), Mass Median Aerodynamic Diameter (MMAD) and Geometric Standard Deviation (GSD). Results can be reviewed in tabulated formats, graphical outputs or configurable reports.

Compliance and Data Integrity

Inhalytix®+ is designed to support the data management requirements of regulated pharmaceutical laboratories, aligning with Good Manufacturing Practice (GMP) principles and electronic record requirements in accordance with 21 CFR Part 11.

Key features supporting compliance and traceability include:

- **Role-based user management:** secure, permission-based user management with defined roles, strong password policies and accountability tracking
- **One-click auto validation:** system-wide validation verifies that all calculation algorithms work correctly, ensuring data reliability and regulatory compliance.
- **Comprehensive audit trails:** all user actions are recorded, providing clear attribution for data entry, modifications and approvals to provide complete traceability.
- **Electronic data records:** all results are securely stored with linked metadata, method details and equipment information to maintain full data integrity.
- **Structured report sign-off:** enforces formal review and approval workflows in line with electronic record-keeping standards.

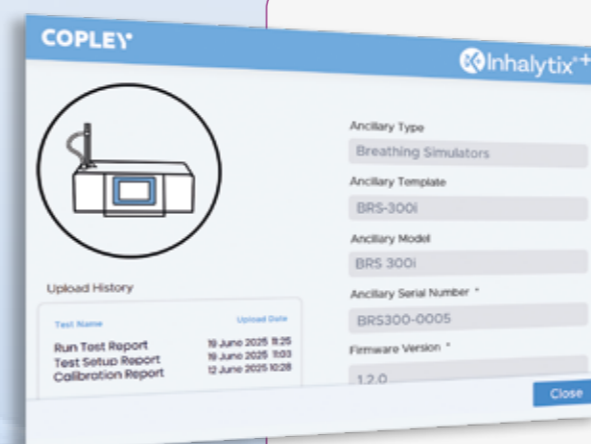

Aligned with Global Pharmaceutical Regulatory Standards

Inhalytix®+ supports compliance with major international pharmacopoeias and regulatory authorities including Ph. Eur., EMA, USP, FDA, JP, CFDA and ChP. This ensures data meet the global regulatory standards from the outset.

Inhalytix+ enables laboratories to maintain efficient digital workflows while adhering fully to current regulatory requirements.



Integrated Equipment Management

Inhalytix®+ supports the integration of laboratory equipment used in inhaler testing, allowing instrument information and operational parameters to be linked directly to APSD measurement data. This enables laboratories to maintain a digital record of the equipment used during testing and ensures that relevant metadata remains associated with each dataset.

Centralised Equipment Inventory

The platform creates a digital inventory that consolidates all equipment records in one place. Each item can be linked to key details such as:

- **Model and serial number**
- **Firmware version**
- **Calibration and maintenance history**
- **Usage and operational data**

This metadata can be linked directly to test methods and analytical results, supporting traceability and improving the visibility of equipment usage across the laboratory.



Connected and Non-Connected Equipment

Inhalytix®+ supports two flexible ways to integrate equipment data, allowing laboratories to maintain consistent records regardless of connectivity.

- **Connected equipment:** Compatible Copley ancillary and automation tools can connect directly to Inhalytix®, enabling operational parameters such as flow rate, test duration and cycle counts to be imported during test execution.
- **Non-connected equipment:** For equipment without direct connectivity, users can manually record the instruments used during testing, ensuring that equipment information remains associated with the corresponding analytical data.



Future Integration

Compatibility with connected laboratory equipment is a core design principle of Inhalytix®+. The platform supports evolving connected inhaler testing systems, allowing laboratories to adopt new capabilities without changes to their core data management platform.

This enables laboratories implementing Inhalytix®+ today to respond to evolving testing technologies.

A Fully Connected APSD Workflow

APSD measurement involves multiple inter-dependent stages, from equipment configuration through to data analysis and reporting. Inhalytix®+ structures these processes within a defined three-step workflow that standardises data capture and reinforces traceability at every stage of analysis



1. Prepare

Define Method, Equipment, and Reports

• Method Configuration

Each test method is tailored to the specific product and its analytical requirements. Users can define APIs, stage groupings, Fine Particle Dose (FPD) thresholds, and reporting settings. Depending on the product type, either delivered dose or drug substance delivery rate can be selected. Inhalytix®+ supports up to six APIs per method, making it suitable for combination products and complex formulations.

• Equipment Setup

Using a visual drag-and-drop interface, users can build product-specific equipment setups from a built-in library that includes impactors, impingers, flow controllers, breathing simulators, and other ancillaries. The system guides users to select only valid equipment combinations. Inhalytix®+ also connects with automation tools such as Vertus® III/+ shake & fire systems, and the Impactor Genie™ IG 200i for automated drug recovery. These integrations capture key parameters directly, minimising manual data entry and ensuring consistency across tests.

Equipment Bench

The Equipment Bench lets users create and save their own custom equipment setups, reflecting the specific configurations used in different labs or test environments. Multiple benches can be created and recalled instantly, allowing teams to select the appropriate setup based on where a test is being run. This eliminates repetitive data entry, saves time, and ensures consistency across methods, teams, and sites.



• Report Customisation

Report templates are fully customisable and can be saved for reuse across different methods. Users can select between detailed or summary formats and can control which metrics are included. Company branding can be added to the report header, making the reports suitable for both internal reviews and external submission.



2. Execute

Enter or Import Data

Once the method, equipment and reporting setup are defined, users can begin testing by entering the number of doses actuated and recording drug deposition values for each stage of the impactor. This includes any additional components configured in the test setup, such as induction ports or preseparators. This process is repeated for each run in the series.

Data can be imported from CSV or XLSX files or entered manually. All entries are displayed in a clear, scrollable table, allowing users to review and edit values before proceeding with analysis.



3. Analyse

Calculate and Review Result

Inhalytix®+ calculates metrics using validated algorithms, ensuring consistent, reliable outputs. Each result is fully traceable, linked to the specific method, equipment configuration and metadata used in the test.



Results are available in multiple formats to support different review and reporting needs:

- ✓ Scrollable summary tables
- ✓ Standard or fully customised reports
- ✓ Graphs including log-probit plots and deposition profiles
- ✓ Grouped results by stage or component
- ✓ Side-by-side comparisons of up to three tests

Calculated Metrics

To support in-depth product evaluation, Inhalytix®+ generates a comprehensive set of standard performance metrics, including:

- Total Dose per Shot
- Delivered Dose
- Fine Particle Dose (FPD)
- Fine Particle Fraction (FPF)
- Mass Median Aerodynamic Diameter (MMAD)
- Geometric Standard Deviation (GSD)
- Regression Coefficient (R²)
- Large Particle Mass (LPM)
- Small Particle Mass (SPM)
- Impactor-Sized Mass (ISM)
- LPM/SPM Ratio
- Fine Particle Mass (FPM)
- Extra-Fine Particle Mass (EPM)
- Coarse Particle Mass (CPM)

Summary of Key Features

- Integrated platform for data entry, analysis and reporting
- Structured workflow for method configuration, execution and analysis
- Automated calculation of key APSD performance metrics
- Role-based user management with comprehensive audit trails
- Test method parameters and equipment metadata linked to each test run
- Centralised equipment inventory and traceability
- Supports connected and non-connected laboratory equipment
- Customisable report templates and graphical data outputs
- Designed to support electronic records in regulated laboratory environments

Technical Specifications

Installation options are available to support different laboratory IT environments:



Standalone installation:

Ideal for single users or smaller teams, the software is installed directly on a PC, with all data stored locally on that machine.



Network installation:

Suitable for larger teams, the software can be deployed on a central server within your local network. This setup allows authorised users to access Inhalytix®+ from connected workstations, enabling centralised data storage, simplified backups, and access to the same validated software version.

Both installation options support compliance with data integrity standards and can be validated according to GMP or 21 CFR Part 11 requirements.

Minimum System Requirements



Operating System:
Windows 10 or Windows 11,
Windows Server 2016, 2019,
2022 and 2025



Processor:
Dual Core CPU



Memory:
Minimum 8 GB RAM



Storage:
500 MB of available disk
space required for install



Display:
1280 x 768 (suggested
minimum), 1920 x 1080
(recommended)



Connectivity:
Ethernet required for
communication between
Inhalytix+ and connected
equipment

Subscription & Support

Inhalytix®+ is provided as a subscription that includes:

- ✓ Unlimited test run analyses
- ✓ Continuous compliance and feature updates
- ✓ Built-in audit trails
- ✓ Customisable methods and reporting
- ✓ Full technical support
- ✓ Optional user training packages

Licensing

- ✓ Three-year subscription
- ✓ Licences available for teams of three users or more

Inhalytix®+

Cat. No.	Description
8265P	Inhalytix+ Software Licence (3 users, valid for 3yrs) - PC
8265S	Inhalytix+ Software Licence (3 users, valid for 3yrs) - Server
8266	Additional User Licence for Inhalytix+ (valid for 3 yrs) (each)
8021	1 Port RS-232 to Ethernet Adapter for Inhalytix+
8022	2 Port RS-232 to Ethernet Adapter for Inhalytix+
8024	4 Port RS-232 to Ethernet Adapter for Inhalytix+



Ethernet Adapter for Inhalytix+

Ancillary and automation equipment can be connected to Inhalytix®+ either via ethernet adapter (Cat. Nos. **8021**, **8022** or **8024**) or, where supported, through direct connection using compatible firmware. To confirm compatibility with existing equipment, please contact sales@copleyscientific.co.uk

See Inhalytix®+ in Action

Inhalytix®+ delivers clarity, consistency, and confidence at every stage of APSD measurement. From data capture to regulatory-ready reporting, it unifies processes and supports efficient, decision-focused workflows.

If you would like to see how Inhalytix+ could work for you, we recommend booking a personalised demo with one of our Application Specialists. This is the most effective way to explore the platform's features, understand integration options, and discuss your specific requirements.

To arrange a demo or discuss your needs in more detail, please contact us:

✉ sales@copleyscientific.co.uk
 ☎ +44 (0)115 961 6229

Improving IVIVCs

Predicting the pharmacokinetic and pharmacodynamic (PK/PD) properties of orally inhaled and nasal drug products (OINDPs) using methods such as *in vitro* lung deposition modelling and *in silico* PK modelling can be problematic, given the dynamic nature and complex geometry of the lungs, not to mention the need to consider different lung deposition mechanisms (diffusion, sedimentation, impaction etc.) and patient-to-patient variability.

Making a relatively small investment in systems that enhance the clinical realism of standard pharmacopoeial *in-vitro* test set-ups for the delivered dose uniformity (DDU) testing and aerodynamic particle size distribution (APSD) measurement may help bridge the gap between data collected during quality control (QC) testing and *in vivo* performance helping to accelerate and improve research and development (R&D).

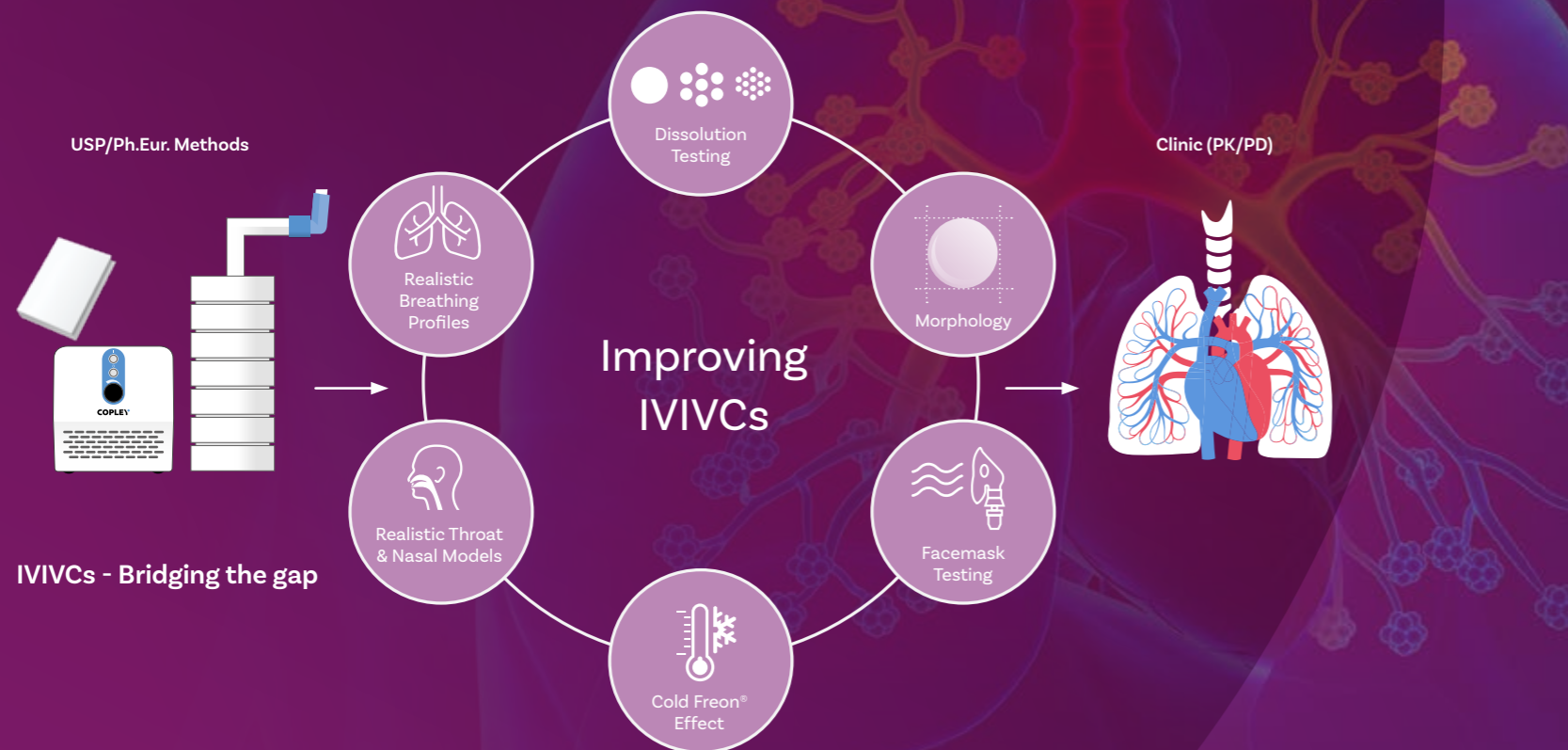

Assessing Drug Efficacy

The core *in vitro* tests for OINDPs, for DDU testing and APSD measurement are highly repeatable and validated methods relied upon for product QC. However, in R&D, the requirement is to understand product behaviour better and optimise performance to deliver targeted *in vivo* drug deposition.

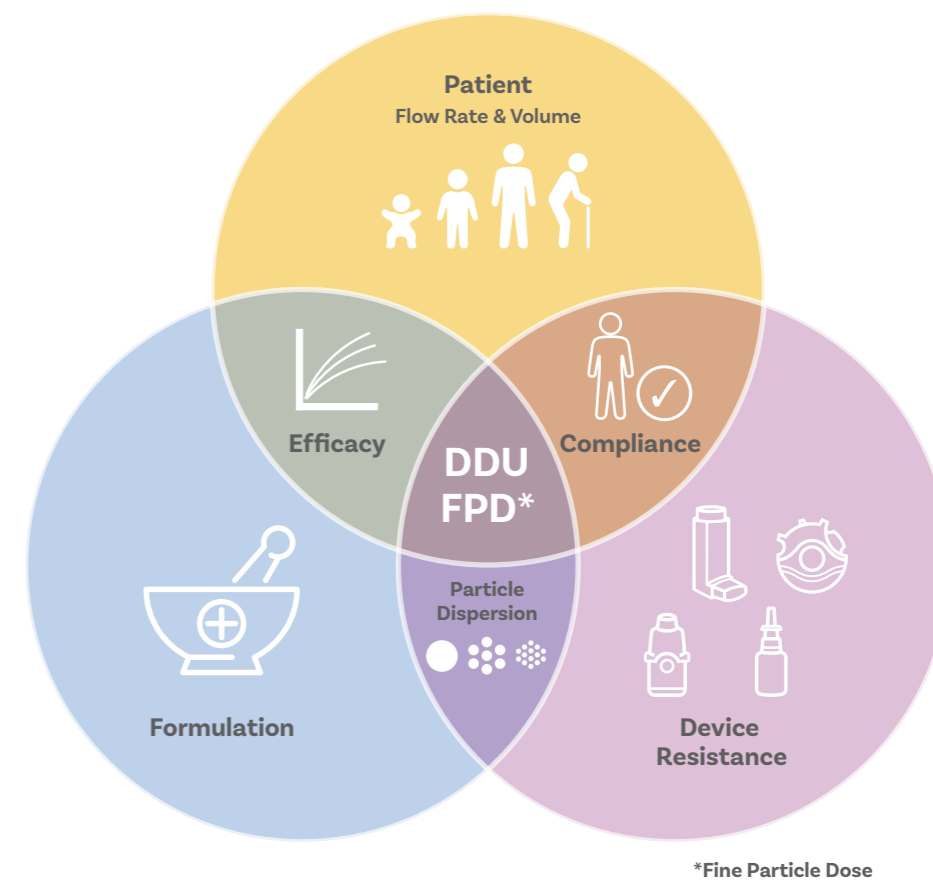

In this environment, accuracy and sensitivity alone do not maximise the utility of *in vitro* testing. Due to the complex interactions between formulation and device and the impact of patient-to-patient variability, identifying robust relationships between product characteristics and clinical efficacy can be challenging - very few good IVIVCs exist for OINDPs.

Demonstrating Bioequivalence (BE)

One way to assess *in vivo* performance is to compare the characteristics of a test (T) OINDP, typically a generic, relative to those of a reference (R) product. Demonstrating bioequivalence between T and R reduces the need for clinical testing providing the *in vitro* tests capture variability in *in vivo* behaviour. Better IVIVCs are therefore important for the robust demonstration of BE, a prerequisite for regulatory submissions for generics.

In a similar way better IVIVCs also support Quality by Design (QbD) which calls for the systemic identification and control of all parameters that have an impact on the clinical efficacy of a drug product. *In vitro* methods are therefore far more useful in QbD studies if they accurately reflect *in vivo* behaviour.

For OINDPs it is possible to identify Critical Quality Attributes (CQAs) relating to the Patient, Device and Formulation. The impact of variability in all of these parameters is necessarily a focus in product development and more easily studied if the clinical realism of *in vitro* test methods is improved.

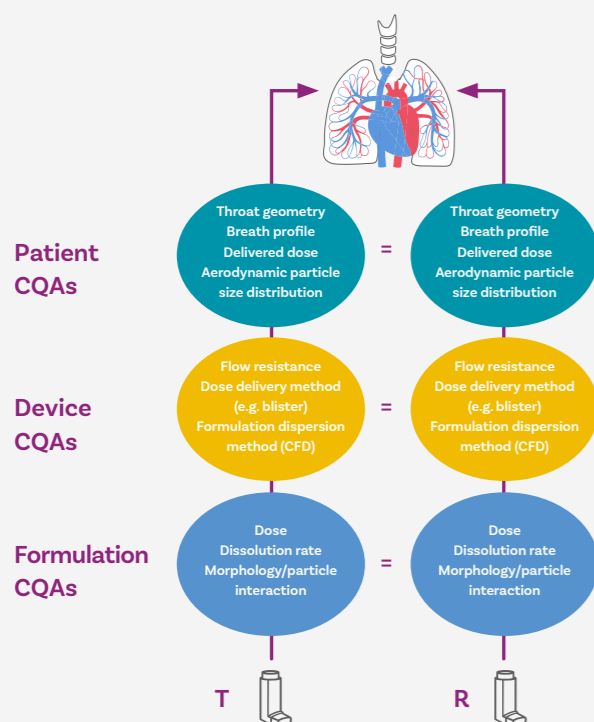

By Grouping the Critical Quality Attributes (CQAs) based on 'Patient', 'Device' and 'Formulation', a greater understanding of the relative difference between the Test (T) and Reference (R) formulations can be ascertained, accelerating the commercialisation of efficacious products and in the case of generics, a more reliable demonstration of bioequivalence.

Not only this, but this 'sameness' method provides a deeper understanding of the performance between different formulations under test. With this additional data, the most promising candidates can be put forward for clinical trials, potentially reducing the risk of clinical trial failure.

Regulatory Guidance

Enhancing the clinical relevance requirements of *in vitro* testing safeguards data quality, patient safety and clinical efficacy.

Despite the slow uptake of a QbD approach to OINDP development, regulators are now beginning to take a more defined position regarding its implementation.

Improving the clinical relevance of *in vitro* tests and *in silico* models is an important area of focus for both the industry and for regulators, largely because of demand for generic OINDPs. This is reflected in the recent investments made by the FDA for the identification, development and validation of clinically relevant *in vitro* testing methods.

Beclomethasone Dipropionate Inhalation Aerosol Draft Guidance (2019)

The FDA has released product specific draft guidance highlighting the use of novel *in vitro* testing approaches for the assessment of Beclomethasone Dipropionate aerosol as an alternate to a comparative clinical endpoint BE study.

The guidance lists additional supportive *in vitro* studies that can be conducted to support and enhance clinical realism and improve IVIVCs. These studies include the use of representative mouth-throat models and breathing profiles; the characterisation of aerosol velocity profiles and evaporation rate; drug dissolution testing; and a full assessment of particle morphology.

Designed to bridge the knowledge gap between *in vitro* and *in vivo* OINDP performance, our range of IVIVC test equipment provides analysts with the tools required to assess test products under conditions that more closely replicate *in vivo* performance for the most representative testing. There are a number of ways to adapt the existing regulatory standard systems to improve clinical realism for all inhaled drug types, as shown opposite.

Methods for Improving IVIVCs

DDU and APSD Testing

Realistic Breathing Profiles

Most OINDPs are routinely assessed using constant air flow rate conditions, which are not representative of the inhalation/exhalation profiles of human subjects. Different patients exhibit different breathing profiles, which may affect the efficiency of drug delivery especially for passive devices such as dry powder inhalers (DPIs).



See page 230.

Realistic Throat and Nasal Models

The standard Ph.Eur./USP Induction Port is known to poorly represent aerosol transport through the upper respiratory tract. Using more realistic throat and nasal models enables a more representative assessment of drug delivery to the target site.



See page 232.

Dissolution Testing

In vitro dissolution testing is becoming more widely used for optimising efficacy during drug development, ensuring batch-to-batch consistency and in some cases to predict bioavailability *in vivo* and help demonstrate BE.



See page 242.

Facemask Testing

In situations where the user lacks the capability of using a mouthpiece (e.g. small children, the elderly), it is commonplace to use a facemask for inhaled drug delivery. The amount of inhaled drug available to the patient is dependent upon the interface between the facemask and the patient and must be rigorously quantified under representative conditions.



See page 250.

Morphology

Profiling the morphological properties e.g. particle size and shape of an inhaled drug formulation may be useful for comparative assessment against a reference drug product notably to assess aerosolisation performance and the extent of deagglomeration.

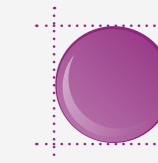

See page 260.

Cold Freon® Effect

Users of MDIs and nasal sprays may well be familiar with the "cold Freon®" effect - the inadvertent reaction, such as a cough, to the chilling sensation at the back of the throat following actuation of the device. Caused by impaction of the delivered dose and the rapid evaporation of any remaining propellant, the cold Freon® effect strongly influences the efficiency of drug delivery.

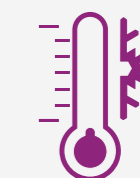

See page 261.

Improving IVIVCs

DDU and APSD Testing

Two factors that have been identified as being critical to improving the clinical relevance of DDU testing and APSD measurement are:

Realistic Breathing Profiles



Replacing the existing constant air flow rate conditions used in testing with breathing profiles more representative of the conditions applied by specific patient populations.

Realistic Throat and Nasal Models



In the case of APSD measurement, replacing the existing Ph.Eur./USP Induction Port with an age-appropriate mouth/throat or nasal model with a more realistic human-like geometry.

Realistic Breathing Profiles

Human beings do not breathe at a constant flow rate. Rather the breathing cycles generated by patients produce a continually varying flow rate - very different to the fixed, steady-state flow rates used during *in vitro* testing. Applying more representative breathing profiles can therefore help to achieve better IVIVCs.

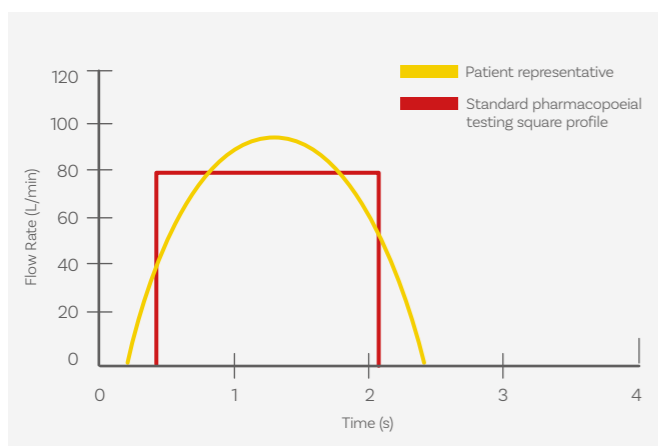

Whilst the use of breathing simulators is currently only specified by regulators for the dose uniformity assessment of MDIs with spacers/VHCs and also for nebulisers, they can be applied to the assessment of other OINDPs in order to improve clinical realism of the impactor-sized mass obtained during APSD measurement.

Furthermore, the dose delivery and aerosol generation/dispersion characteristics of many inhaled products (especially passive devices) are known to be sensitive to flow rate properties, such as acceleration, peak flow and inhaled volume creating an additional incentive for use.



Using data acquired from the clinical use of spirometers, breathing simulators are used to generate representative breathing profiles, offering the chance to more closely assess how factors such as the strength of inhalation and lung capacity can affect the performance for passive devices such as DPIs.

See page 156 for more information about our range of Breathing Simulators.

Mixing Inlet

Applying more representative breathing profiles using a breathing simulator during APSD measurement is complicated by two key issues:

- 1 The impactors used to measure APSD must operate at a constant flow rate.
- 2 The test flow rate applied to the inhaler may need to be lower than the minimum calibrated flow rate of the impactor. For example in paediatric studies a representative flow rate may be 10 L/min but the impactor may have a minimum calibrated operating flow rate of 28.3 L/min.



Mixing Inlet (NGI), Mixing Inlet (ACI)

Our Mixing Inlets are designed to allow the cascade impactor to operate at a constant flow rate, whilst permitting a lower fixed or variable rate to pass through the inhaler. Positioned between the induction port/throat/nasal inlet and cascade impactor, Mixing Inlets decouple the flow rate through the device from the air flow drawn through the impactor, enabling more representative testing.

Mixing Inlet

Cat. No.	Description
8328A	Mixing Inlet for ACI, FSA and MSLI (316 Stainless Steel)
8326	ACI to NGI Outlet Adapter
8327	NGI to ACI Outlet Adapter
8329A	Mixing Inlet for NGI and FSI (316 Stainless Steel)
8324	Set of 2 O-Rings for ACI Mixing Inlet
9160	Compressed Air Flow Controller for Mixing Inlet
9164	Air Compressor for Mixing Inlet
9165	Compressed Air Flow Controller Re-Calibration Certificate
9166	Maintenance Kit for Air Compressor

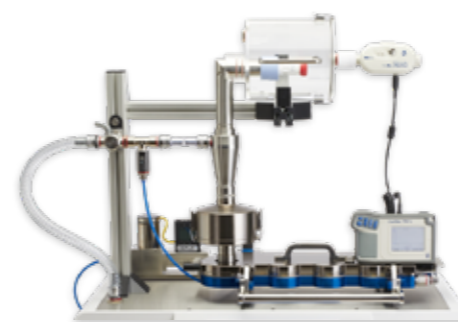

Real-Time Breath Verification Profile Chamber (BVC)

Breathing Simulator Qualification Tools

We offer an extensive range of qualification tools for our range of Breathing Simulators, including a Real-Time Breath Profile Verification Chamber (BVC) to measure and record the breathing profile generated. See page 156 further information.

Realistic Throat and Nasal Models

The drug mass sized by the cascade impactor (impactor sized mass) should ideally be representative of the dose that would actually enter the lungs. To achieve this, the induction port or other accessory used to interface the device to the impactor must capture a representative fraction of the dose. Knowledge of the portion of the

dose captured in the throat or nasal airway is essential to understand the dosage delivery characteristics of a given OINDP. In many cases, the portion of the dose collected in the throat or nasal airway represents a significant proportion of the delivered dose.

Unlike standard induction ports, our models are optimised for a diverse range of patient profiles. Validated via extensive research, our throat and nasal models are designed to be representative of typical patient populations. Each were developed using insights from CT and MRI scans, direct observations of living subjects, and data from archival literature, each model has a standardised internal geometry that closely mimics *in vivo* physiology.

For further information, please see the following papers:

Grgić, B et al., 2004. Regional aerosol deposition and flow measurements in an idealized mouth and throat. *Journal of Aerosol Science*. 35; 21-32.

Chen, J et al., 2022. In Vitro Regional Deposition of Nasal Sprays in an Idealized Nasal Inlet: Comparison with In Vivo Gamma Scintigraphy. *Pharmaceutical Research*. 35; 3021-3028.

Or contact us at info@copleyscientific.co.uk

Alberta Idealised Throat AIT

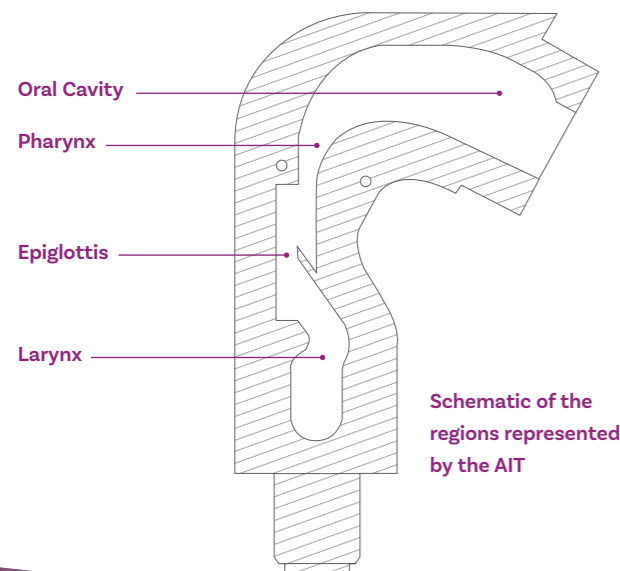

For orally inhaled products (OIPs), the AIT provides analysts with data more representative of measured *in vivo* behaviour, by ensuring that the ISM corresponds with the portion of the aerosol that would likely enter the lungs.

With a standardised, highly reproducible, human-like geometry, the AIT offers robust performance independent of flow rate and is designed to make drug recovery quick and simple.

Two versions of the AIT are available:



Both come complete with mensuration and leak test certificates.

Key Features:

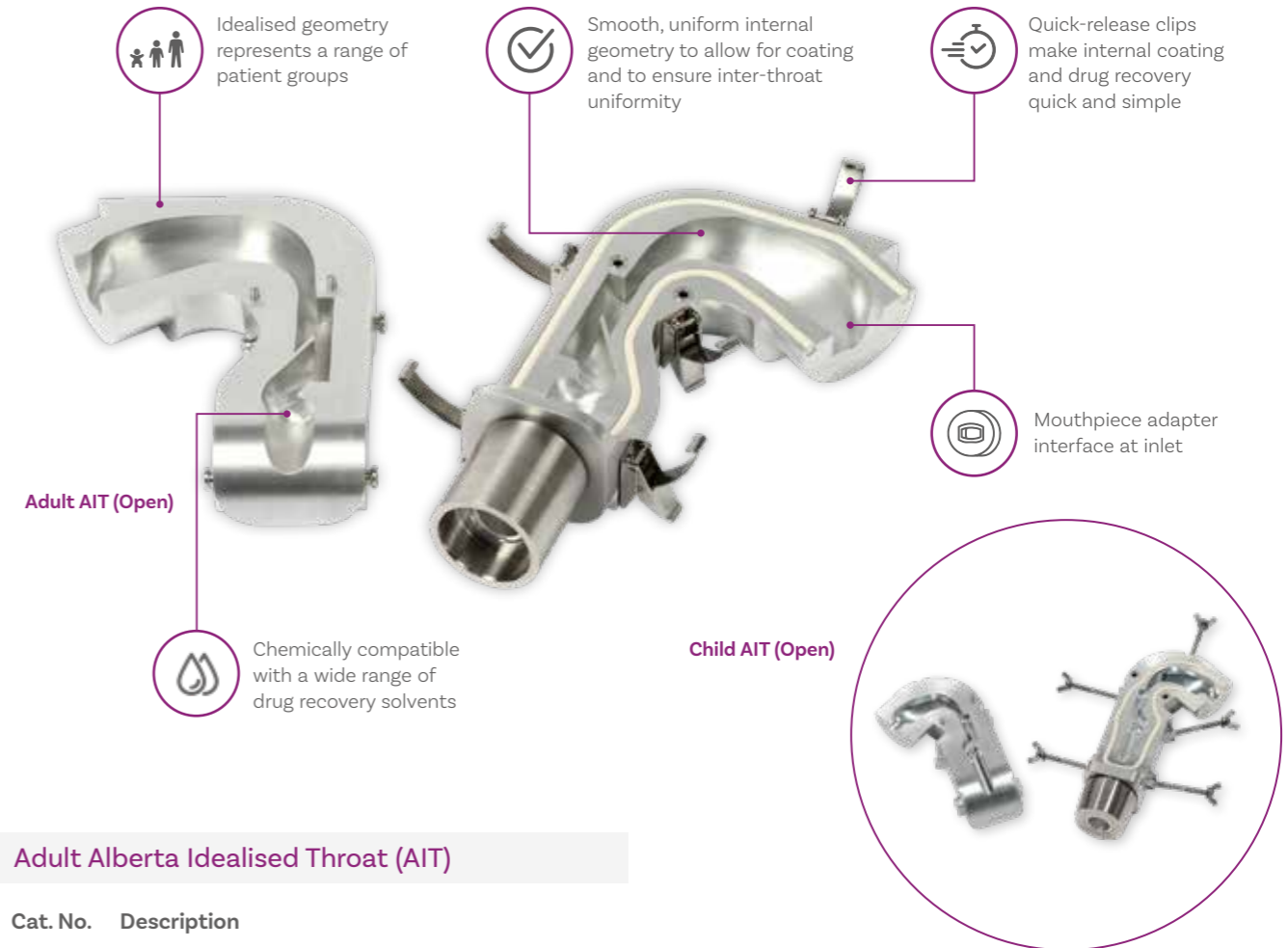

Adult Alberta Idealised Throat (AIT)

Cat. No.	Description
8511	Adult Alberta Idealised Throat (AIT) in Aluminium

Accessories

8512	Alberta Idealised Throat to ACI/FSA Adapter
8517	FRS Flow Meter Adapter for Adult Alberta Throat
8513	Alberta Idealised Throat to NGI/FSI Adapter
8514	DFM to Adult Alberta Idealised Throat Adapter
8516	Spare Silicone Seal for Adult AIT
8518	Leak Test Inlet Cap and Outlet Adapter for Adult AIT

Child Alberta Idealised Throat (AIT)

8530	Child Alberta Idealised Throat (AIT) in Aluminium
------	---------------------------------------------------

Accessories

8512	Alberta Idealised Throat to ACI/FSA Adapter
8513	Alberta Idealised Throat to NGI/FSI Adapter
8531	DFM to Child Alberta Idealised Throat Adapter
5239	FRS Flow Meter Adapter
8532	Spare Silicone Seal for Alberta Idealised Throat (Child)
8533	Leak Test Inlet Cap and Outlet Adapter for Child AIT



Outlet adapters available to connect the AIT to NGI, ACI, FSI and FSA

Alberta Idealised Nasal Inlet AINI

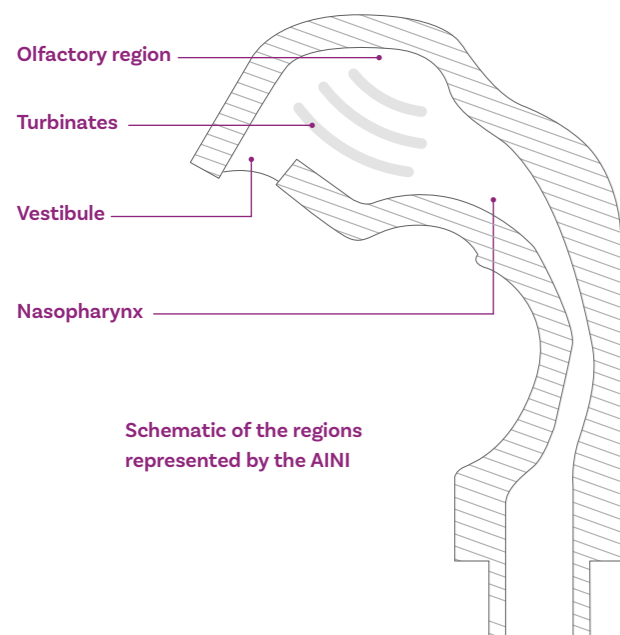

Understanding and optimising regional deposition is essential to maximise the fraction of drug absorbed via the target pathway and to minimise drug transit to the lungs. For nasally inhaled products, the AINI enables representative testing of the deposition of drug within the nasal airways.

Made up of 4 separate parts: vestibule, turbinates, olfactory region and nasopharynx, the AINI enables representative testing of drug deposition within the nasal airways. The AINI accurately mimics deposition behaviour in each region, allowing the collection of drug samples that reflect the corresponding fraction of the dose for analysis.

The AINI is easily separated into its component parts to enable drug recovery and assay for each individual area.

Key Features:

- Quick-release clips make internal coating and drug recovery quick and simple
- Idealised geometry representing a range of patient groups
- Smooth, uniform internal geometry for more representative testing to allow for coating and to ensure inter-nasal passageway uniformity
- Seals ensure leak-free testing
- Chemically compatible with a range of solvents
- Manufactured from aluminium for durability and to ensure dimensional reproducibility

Nosepiece Adapter for AINI
Creating an airtight seal between the AINI and test device, the Nosepiece Adapter for AINI enables passive nasal devices to be used under air flow rate (predominantly single dose nasal powders)

Alberta Idealised Nasal Inlet (AINI)

Cat. No.	Description
8540	Alberta Idealised Nasal Inlet (AINI) for NGI/FSI
8541	Alberta Idealised Nasal Inlet (AINI) for ACI/
8544	Nasal Device Nosepiece Adapter for AINI
8326	ACI to NGI Outlet Adapter
8327	NGI to ACI Outlet Adapter
8543	Alberta Idealised Nasal Inlet Leak Test Cap and Inlet Adapter
8546	DFM 2000 to AINI Adapter
8547	FRS to AINI Adapter

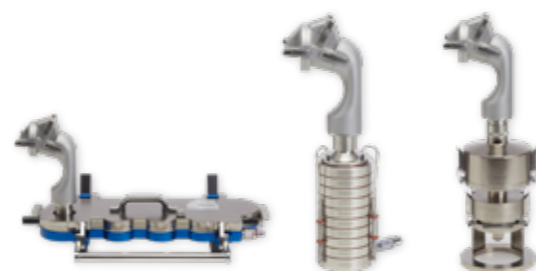

Different outlet adapters are available for a range of applications

Improving IVIVCs: Example Test System for Realistic DDU

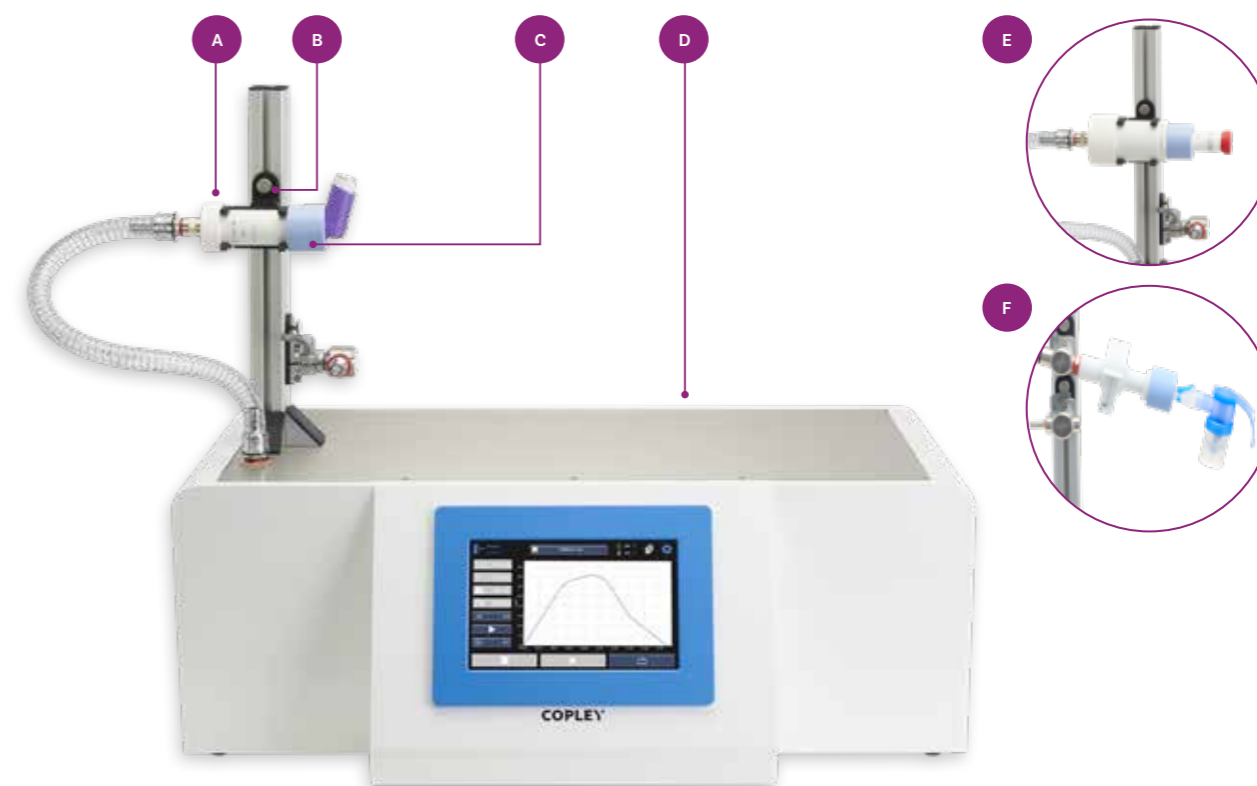

IVIVC System for DDU Testing of MDIs

- A Dose Uniformity Sampling Apparatus (DUSA) for MDIs
- B Inhaler Testing workstation (ITW) DUSA Holder
- C Mouthpiece Adapter
- D Breathing Simulator
- E Alternative dose collection device: DUSA for DPIs
- F Alternative dose collection device: Advanced Filter Holder

Improving IVIVCs - Realistic DDU Testing System Components



Breathing Simulator BRS

With an intuitive touchscreen interface for easy operation, our range of Breathing Simulators are designed to produce breath profiles across a range of ages (paediatric to geriatric) and patient conditions (mild to severe lung impairment).

For further information about the range, see page 156.

Required for:



In addition to the Breathing Simulator, the following is needed to complete a fully-operational IVIVC test system for DDU testing:

Dose Collection Device

DUSA for MDIs, SMIs and Nasal Aerosols. See page 20.

Required for:



DUSA for DPIs and Nasal Powders. See page 22.

Required for:



Advanced Filter Holder for MDIs with Spacers/VHCs and Nebulisers. See page 26.

Required for:



Mouthpiece Adapters

Moulded from high quality silicone rubber, our Mouthpiece Adapters guarantee an airtight seal between the inhaler under test and the test apparatus.

Required for:



Nosepiece Adapters

Our Nosepiece Adapters interface the nasal device with the test system.

Required for:



See page 214 for further information.

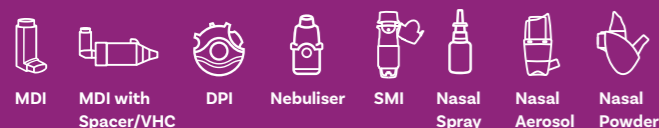

Improving IVIVCs: Example Test System for Realistic APSD



IVIVC System for APSD Measurement of DPIs

- A** Compressed Air Source
- B** Compressed Air Flow Controller
- C** Alberta Idealised Throat
- D** Mouthpiece Adapter
- E** Mixing Inlet
- F** Preseparator
- G** Cascade Impactor
- H** Breathing Simulator
- I** Flow Rate Sensor FRS
- J** Vacuum Pump
- K** Critical Flow Controller TPK

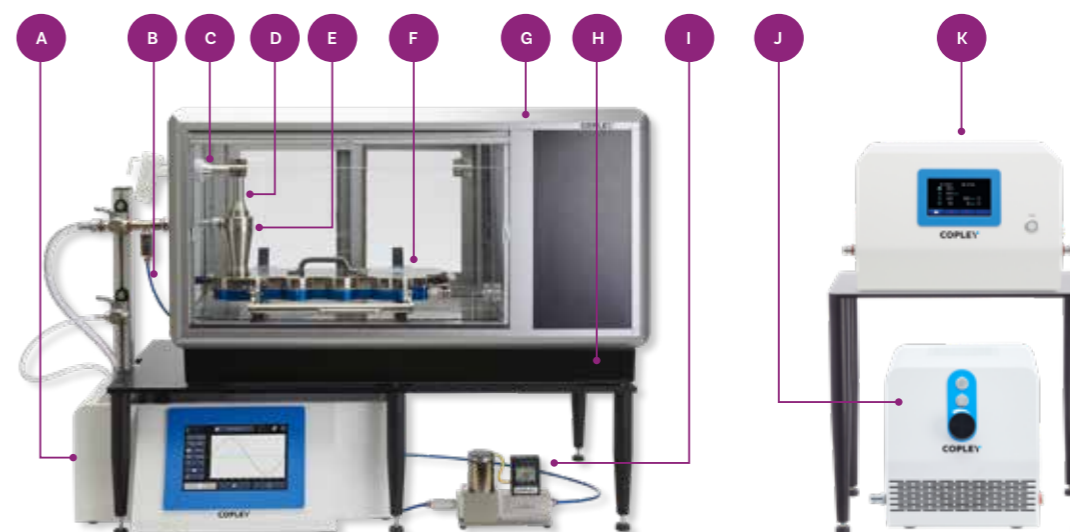

IVIVC System for APSD Measurement of Nebulisers

- A** Breathing Simulator
- B** Compressed Air Source
- C** Mouthpiece Adapter
- D** Induction Port
- E** Mixing Inlet
- F** Cascade Impactor
- G** NGI Cooler™
- H** NGI Cooler Stand for BRS 200i
- I** Compressed Air Flow Controller
- J** Vacuum Pump
- K** Breath Actuation Controller BAC

Improving IVIVCs - Realistic APSD Testing System Components

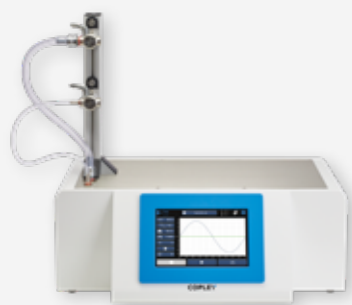

Breathing Simulator BRS

With an intuitive touchscreen interface for easy operation, our range of Breathing Simulators are designed to produce breath profiles across a range of ages (paediatric to geriatric) and patient conditions (mild to severe lung impairment).

For further information about the range, see page 156.



Mixing Inlet

Decoupling the flow rate through the device from the air flow drawn through the impactor, the Mixing Inlets are needed to enable the cascade impactor to continue to operate at a constant flow rate, whilst allowing a lower fixed or variable rate to pass through the inhaler.



Alberta Idealised Throat AIT

With a standardised, highly reproducible, human-like geometry, the AIT offers robust performance independent of flow rate and is designed to make drug recovery quick and simple. Adult and child (6-14 years) versions are available.



Alberta Idealised Nasal Inlet AINI

Mimicking nasal drug deposition behaviour in the vestibule, turbinates, olfactory region and nasopharynx, the AINI helps users to identify the fraction of the drug absorbed via the target pathway and realistically evaluate any unintended drug transit to the lungs.



In addition to the Breathing Simulator, Mixing Inlet and a realistic throat/nasal model, the following is needed to complete a fully-operational IVIVC test system for APSD measurement:



Cascade Impactor

Forming the basis of most systems used to measure APSD, a choice of cascade impactors is available depending on device type and application. See page 84 for further information about our range of Cascade Impactors.



Vacuum Pump

Our Vacuum Pump range represents the latest in high performance, low maintenance, technology and is specifically designed for use in the testing of OINDPs. See page 188 for further information about our Vacuum Pump range.



Critical Flow Controller TPK

Positioned between the cascade impactor and vacuum pump, the Critical Flow Controller TPK 100i ensures critical (sonic) flow conditions during IVIVC testing. This ensures changes to balancing flow from the compressed air supply do not affect the cascade impactor flow rate. See page 172 for further information about our Flow Controller range.



Flow Rate Sensor FRS

Used for establishing accurate and consistent inlet flow rate during testing. See page 184 for further information about flow rate measurement.

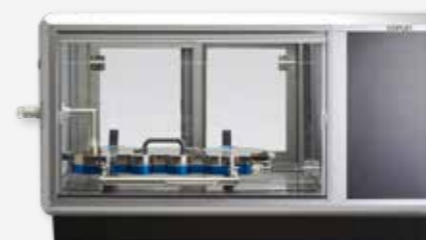

NGI Cooler™

Accommodating the NGI both open and closed, the NGI Cooler maintains a temperature-controlled environment throughout testing. Additional space allows for the cooling of extra sets of collection cups, so that multiple tests can be undertaken in quick succession. The NGI Cooler is also suitable for cooling of the Andersen Cascade Impactor ACI. See page 202 for further information.

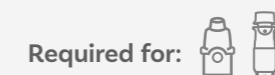



NGI Cooler™ Stand for BRS 200i

Supports interfacing of the NGI Cooler with the BRS 200i, whilst saving precious benchtop space.

See page 202 for further information.

Required for:

Compressed Air Flow Controller

Designed to balance the steady state flow rate entering the impactor, the Compressed Air Flow Controller ensures that the flow rate at the inlet to the induction port is zero prior to starting the test.

Required for:



Air Compressor for Mixing Inlet

To provide supplementary air to the inlet port of the Mixing Inlet via the Compressed Air Controller.

Required for:

Mouthpiece Adapters

Moulded from high quality silicone rubber, our Mouthpiece Adapters guarantee an airtight seal between the inhaler under test and the test apparatus.

Required for:



Nosepiece Adapter for AINI

Creating an airtight seal between the AINI and test device, the Nosepiece Adapter for AINI enables passive nasal devices to be used under air flow rate (predominantly single dose nasal powders).

See page 214 for further information.



Qualification

GMP regulations require that

- The test methods used to monitor pharmaceuticals must meet proper standards of accuracy and reliability
- Companies should establish procedures to ensure the fitness for use of instruments that generate data supporting product testing



Copley provides a range of qualification documentation, services and tools to meet these requirements. See page 324 for further information.

Connected Data Management



Data generated using these equipment configurations may be processed and reported through Inhalytix+, Copley's validated data management platform.

By structuring test methods, automating metric calculation and linking results to user attribution and equipment metadata, Inhalytix+ reduces manual data handling and strengthens data integrity. Where compatible ancillary or automation tools are connected, selected operational parameters can be captured automatically alongside analytical results, supporting traceability and regulatory-aligned reporting.

See page 218 to learn how Inhalytix+ can improve workflow efficiency and strengthen data integrity for APSD measurement workflows.



Vertus® III interface with Breathing Simulator BRS

For the IVIVC testing of MDIs, nasal sprays and nasal aerosols, interfacing the Vertus III/Vertus III+ (see page 292) with the Breathing Simulator Model BRS 300i enables full control of the device actuation parameters (e.g. shaking, actuation force) allowing the fully automated application of patient representative breath profiles. Users can create test methods that fully describe the patient population the product is intended for and thus, create a realistic testing method according to their needs.



For further information about Vertus III, see page 292.

For further information about the BRS 300i, see page 156.

Improving IVIVCs

Cat. No.	Description	Cat. No.	Description
8328A	Mixing Inlet for ACI, FSA and MSLI (316 Stainless Steel)	9161	Compressed Air Inlet Manifold for Mixing Inlet
8326	ACI to NGI Outlet Adapter	9162	Compressed Air Inlet Manifold for Mixing Inlet & BRS 100i
8327	NGI to ACI Inlet Adapter	9163	Compressed Air Inlet Manifold for Mixing Inlet & BRS 200i/300i
8329A	Mixing Inlet for NGI and FSI (316 Stainless Steel)	9164	Air Compressor for Mixing Inlet
8324	Set of 2 O-Rings for ACI Mixing Inlet	9165	Re-calibration of Compressed Air Flow Controller
9160	Compressed Air Flow Controller for Mixing Inlet	9166	Maintenance Kit for Air Compressor

Inhaled Dissolution Apparatus™ IDA

Patent Pending

A purpose-built, integrated system for inhaled dissolution testing

The Inhaled Dissolution Apparatus (IDA) has been developed to support the generation of robust, reproducible inhaled dissolution data suitable for comparative and regulatory use. By integrating controlled particle collection with direct transfer into a dedicated dissolution tester, the IDA minimises manual handling and variability, enabling the generation of discriminatory dissolution profiles to support product optimisation and development decision-making.

Supplied as a complete platform with Copley's DIS 600i-ID or 800i-ID dissolution testers, the IDA provides a harmonised workflow from dose collection through to dissolution analysis. The system accommodates

a wide range of inlets, flow rates and product types, supporting flexible method development across inhaled and nasal drug products.



Improving IVIVCs Dissolution Testing

The dissolution behaviour of orally inhaled products (OIPs) following deposition in the lungs is an important determinant of product performance and comparability. Whether deposited particles dissolve at an appropriate rate to achieve local or systemic effect has direct implications for formulation design, device compatibility and the assessment of bioequivalence.

In response to the cost, variability and timelines associated with clinical endpoint studies, regulators are encouraging the development of more informative *in vitro* strategies for inhaled products. Within this context, inhaled dissolution testing is being considered as a supportive, mechanistic tool that can provide additional discriminatory insight, strengthen weight-of-evidence arguments and help accelerate development by reducing reliance on time-consuming clinical studies.

However, generating meaningful inhaled dissolution data is technically challenging. Low deposited drug mass, small dissolution volumes and uncontrolled sample handling can introduce variability and limit discrimination. Integrated workflows that combine consistent particle collection with direct transfer into dedicated dissolution vessels offer a practical route to improving reproducibility and generating robust, comparative dissolution profiles.

To address these technical and regulatory challenges, Copley has developed the Inhaled Dissolution Apparatus IDA, a purpose-built system designed to deliver integrated, reproducible inhaled dissolution testing.



The small amount of aqueous fluid and surfactant found in the lung make it extremely difficult to mimic inhaled dissolution testing *in vitro*. Marques, Loebenberg and Almukainzi (2011) list five of the most used simulated lung fluids in Table 11 of their article 'Simulated Biological Fluids with Possible Application in Dissolution Testing'.

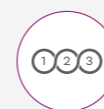

Integrated three-step workflow

Collect, transfer and dissolve inhaled doses within a single, end-to-end system.

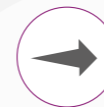

Minimal sample handling

Direct transfer from dose collection to dissolution reduces losses and variability.



Purpose-built for inhaled products

Dedicated paddle and vessel design optimised for low-dose, small-volume inhaled samples.



Reproducible and discriminatory data

Supports generation of repeatable dissolution profiles suitable for comparative assessment.



Supports efficient development

High-quality *in vitro* dissolution data to inform formulation decisions and help streamline development timelines.

Three-Step Workflow for Inhaled Dissolution



1. Collect

Select the inlet appropriate for the method of interest, and capture particles uniformly on the filter. The system enables reproducible deposition across the filter, supporting accurate and representative sampling of the aerosolised dose.



2. Transfer

The filter holder attaches directly to the dissolution paddle, eliminating the need for manual handling of the filter. This streamlined step reduces the risk of sample loss, cross-contamination, or variability - preserving the integrity of the collected dose.



3. Dissolve

Lower the paddle/filter assembly into the flat-bottomed dissolution vessel containing pre-warmed media. The centralised filter holder ensures circulation around the filter, promoting uniform dissolution even with small drug quantities. Built-in alarms and monitoring features help ensure timely sampling and reliable results.



The following is needed to complete a fully-operational test system for inhaled dissolution dose collection:

Compatible Inlet Interfaces

The IDA dose collector interfaces with commonly used inlet configurations to enable collection of the particle size fraction of interest, in line with established OINDP testing methodologies.

Compatible inlets include:

- NGI Induction Port (see page 87)
- NGI Preseparator (see page 87)
- Fast Screening Impactor FSI Housing (see page 270)
- Alberta Throat (adult and child) (see page 232)
- Alberta Idealised Nasal Inlet AINI (see page 233)
- Glass Expansion Chamber - all sizes (see page 208)
- Mixing Inlet for NGI (see page 231)



IDA dose collector with Adult Alberta Throat and FSI Housing



IDA dose collector with NGI Induction Port and FSI Housing



Vacuum Pump

Our Vacuum pump range represents the latest in high performance, low maintenance technology and is, specifically designed for use in the testing of OINDPs.

See page 188 for further information about our Vacuum Pump range.

Flow Controller

Suitable for setting flow rate, measuring key parameters and controlling inhaled volume, our range of Flow Controllers improve testing reproducibility and the ease of method transfer, reducing potential sources of data variability.

See page 172 for further information about our Flow Controller range.



Flow Rate Sensor FRS

Used for establishing accurate and consistent inlet air flow rate during testing.

See page 184 for further information about flow rate measurement.

Inhaled Dissolution Apparatus IDA: System Design and Specifications

Purpose-built paddle and vessel design

The IDA dissolution tester incorporates a paddle and vessel specifically designed for inhaled product testing. The reduced paddle diameter supports dissolution studies using low media volumes while preserving predictable flow behaviour. A flat-bottomed vessel, with a smaller working volume than standard USP vessels, provides stable positioning of the filter holder and promotes uniform circulation around the collected dose, supporting reproducible dissolution conditions at low drug mass.

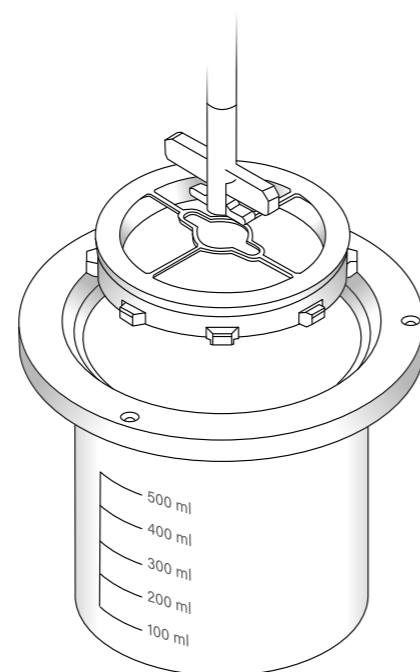

Direct Transfer from Collection to Dissolution

The IDA filter holder attaches directly to the paddle assembly, enabling transfer of the collected dose from particle capture to dissolution without manual handling of the filter. This direct transfer minimises sample loss and disturbance of the deposited particle layer, helping to reduce variability and improve between-test reproducibility.

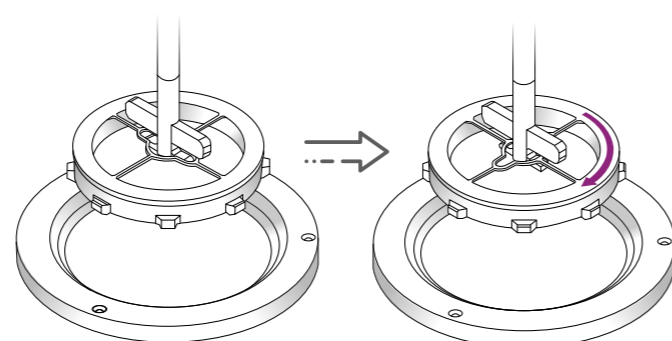

Technical Specifications

Inhaled Dissolution Apparatus - Dose Collector	
Flow Rate Range	5 - 100 L/min
Compatible Inlets	NGI Induction Port NGI Preseparator Fast Screening Impactor Alberta Throat (Child & Adult) Mixing Inlet for NGI & FSI Alberta Idealised Nasal Inlet AINI Glass Expansion Chamber (all sizes)
Filter Type and Size	Glass fibre, 76 mm (diameter)

Inhaled Dissolution Apparatus - Dissolution Tester	
Speed Range	20 - 220 rpm \pm 2%
Number of Testing Stations	6 (DIS 600i-ID) 8 (DIS 800i-ID)
Vessel Volume	200 - 500 mL
Heater	DIS 600i: Low vibration integrated digital heater/circulator DIS 800i: Low vibration independent external digital heater/circulator
Heater Accuracy	\pm 0.1°C
Test Run Time	Up to 100 hours
Data Output	RS 232 USB A (for connection with a USB printer) USB B (for connection with a PC)

Inhaled Dissolution Apparatus™ IDA

Cat No.	Description
1369	Inhaled Dissolution Apparatus - 6 Station System - 230V/50Hz
1369-120/60	Inhaled Dissolution Apparatus - 6 Station System - 120V/60Hz
1389	Inhaled Dissolution Apparatus - 8 Station System
9769	IDA Interface Plate for Vertus III
9765	Label Printer
9719	Thermal Ink Transfer Labels
9725	Ribbon for Thermal Ink Transfer

Sampling/Filters

Cat No.	Description
5240	Box of 100 Glass Fibre Filters
1313	Manual Sampling Cannula Assembly complete (each)
1314	Resident Probe with Luer Fitting (each)

Qualification/Maintenance

Cat No.	Description
8000	IQ/OQ Documentation for Inhaler Testing Systems
5440	Inhaler Testing Qualification Kit Model ITQK2
1309	IQ/OQ Documentation for DIS
1508	DISi - Calibration Tool Kit complete
1372	Julabo Aqua Stabil Water PHMB Free

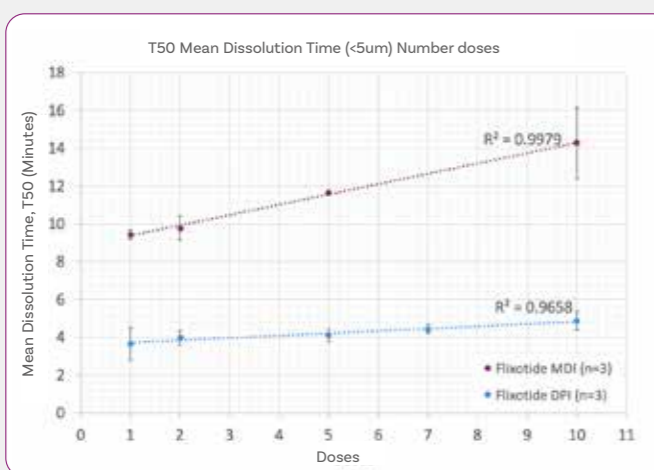

In a comparative study, the dissolution behaviour of fluticasone propionate delivered via MDI (Evohaler, GSK) and DPI (Accuhaler, GSK) was assessed using the IDA.

The dissolution rate, quantified by T50, clearly distinguished the two formulations and demonstrate the IDA's suitability for this purpose:

- The IDA provides repeatable measurements across multiple tests.
- It can clearly differentiate products with distinct dissolution profiles.
- This discriminatory capability is maintained across different dose levels.

Data presented at DDL 2025

USP Dissolution Tester-Based Approaches

Inhaled dissolution testing has traditionally been performed by adapting conventional USP dissolution methodology following particle sizing and dose collection. Prior to the availability of the dedicated, integrated system, several well-established approaches were developed to enable inhaled doses to be transferred into standard USP dissolution testers. These methods continue to be used to support inhaled dissolution assessment in a range of applications.

NGI Dissolution Cups

The NGI Dissolution Cup is a modified NGI collection cup incorporating a removable insert that enables size-fractionated particles to be collected and prepared for dissolution testing. Following particle sizing, the insert is removed, secured with a membrane in a dedicated holder, and placed into a standard USP dissolution tester using a paddle-over-disc style method.

- Enables dissolution testing of size-fractionated aerosol doses
- Established methodology based on NGI particle collection
- Compatible with standard USP dissolution testers



NGI Dissolution Cup and Membrane Holder

NGI Dissolution Cups

Cat. No.	Description
6001	NGI Dissolution Cup and Membrane Holder (each)
6002	55 mm Punch
6004	Pack of 100 Polycarbonate Filters (0.1 micron x 76 mm diameter)
6005	Spare Set of O-Rings

Watchglass / PTFE Assembly

The Watchglass/PTFE Assembly enables particles collected using an Andersen Cascade Impactor (ACI) to be prepared for dissolution testing in a standard USP dissolution tester. Following particle sizing, the membrane on which the particles have been collected is inverted and sandwiched between the glass and mesh surfaces of the assembly, providing a simple and well-established approach for transferring inhaled doses into dissolution testing.

- Established method used with Andersen Cascade Impactors
- Suitable for membrane-based dose collection
- Compatible with standard USP dissolution testers



Watchglass/PTFE Assembly for use with ACI

ACI with Membrane

Cat. No.	Description
6003	Watchglass/PTFE Assembly for use with ACI (each)
6004	Pack of 100 Polycarbonate Filters (0.1 micron x 76 mm diameter)

USP Dissolution Tester

Copley offers a range of USP Method 2 dissolution testers suitable for use with NGI Dissolution Cups and Watchglass / PTFE Assemblies. These testers provide controlled dissolution conditions and are widely used in pharmaceutical laboratories for solid oral dosage forms and adapted inhaled dissolution methodologies.

Further details on Copley's dissolution testers are available in the Expert Solutions for Pharmaceutical Testing brochure.





Improving IVIVCs

Facemask Testing

In many cases, inhaled drug products may be administered using a facemask instead of a mouthpiece. This is often the case for infants and small children and in other situations where the user lacks the capability to use a mouthpiece.

A key factor in determining the amount of inhaled drug available to the patient is the interface between the facemask and the patient. A properly sized mask, firmly placed against the face, for example, will provide the user with far more drug than a poorly fitting equivalent where much of the drug is lost to the environment through leakage.

Due to the important role that a facemask has in transporting the drug aerosol from the device to the patient, further assessment is required in addition to the standard DDU testing and APSD measurement methods routinely applied.

Relevant for two types of devices:



MDIs used with a spacer/VHC and a facemask



Nebulisers used with a facemask

Face Models

A critical component of the test apparatus used for facemask testing is the face model. This should be appropriate to the age group for which the product is intended, e.g. infant, child or adult. Face models should:



Achieve realistic dead space within the mask and at the same time ensure the absence of leaks between the mask and model.



Have physiologically accurate soft facial tissue to simulate *in vivo* conditions.



Provide a means of mounting the spacer/VHC or nebuliser such that the facemask is in correct alignment with the face model as in "real-life" conditions.

We offer a range of facemask testing systems for different devices, which seek to address the above requirements, whilst also providing sufficient flexibility to allow users to utilise their own validated models, if desired. All models are fitted with replaceable face skins.



Filter Holder and Adapter located in a cavity behind the face model's lips

Face Model Products

Cat. No.	Description
9142	FMA/FMS Filter Holder and Adapter for BRS 100i
9143	FMA/FMS Filter Holder and Adapter for BRS 200i/300i
9103	Pack of 100 Filters for Filter Holder
9144	Adult Head and Adapter for FMA/FMS
9145	Child Head and Adapter for FMA/FMS
9146	Infant Head and Adapter for FMA/FMS
9149	Replacement Face Skins for Adult Head (Pack of 6)
9150	Replacement Face Skins for Child Head (Pack of 6)
9151	Replacement Face Skins for Infant Head (Pack of 6)

Test Systems for Assessing Facemask Performance

Two types of apparatus are available, each providing standardised test methods to quantify the effect of using a facemask on drug delivery from the device under test.

1. Facemask Testing Apparatus FMA for MDIs with a Spacer/VHC

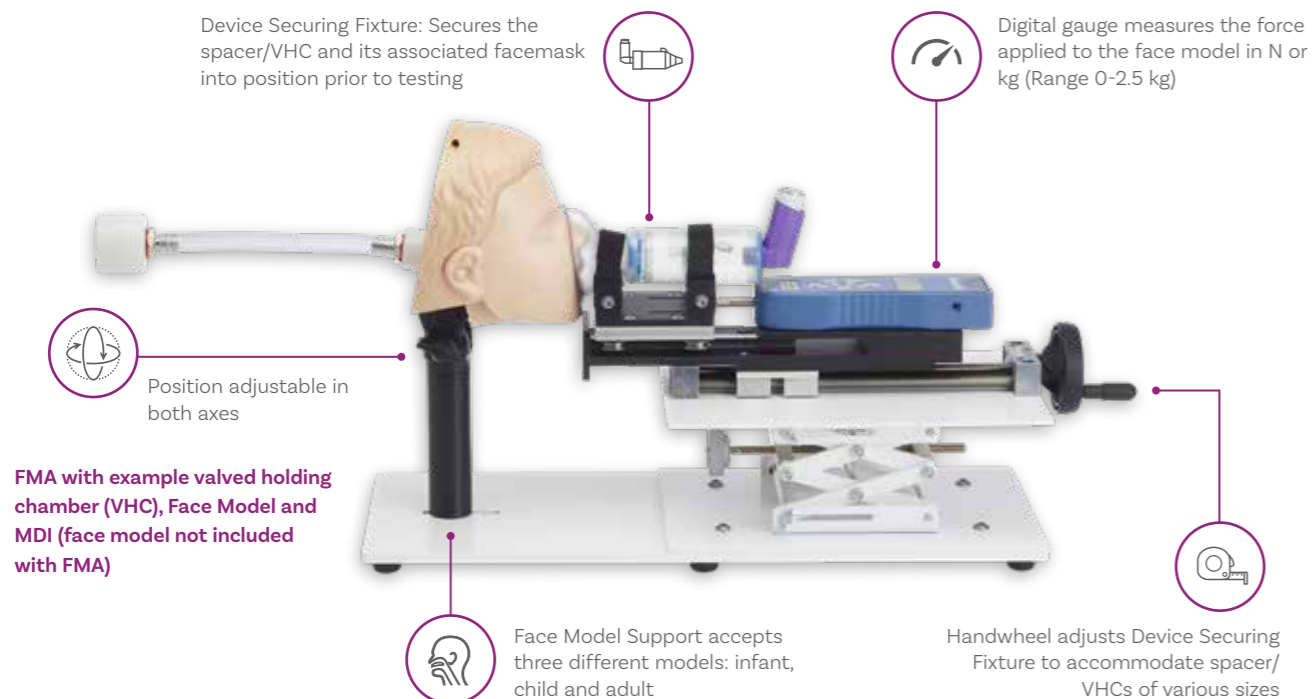

Facemask Testing Apparatus FMA

Cat. No.	Description
9141	Facemask Test Apparatus for Spacers & VHCs Model FMA
9142	FMA/FMS Filter Holder and Adapter for BRS 100i
9143	FMA/FMS Filter Holder and Adapter for BRS 200i/300i

FMA: DDU Testing

- A Breathing Simulator BRS
- B Filter Holder and Adapter
- C Face Model
- D Facemask Apparatus FMA

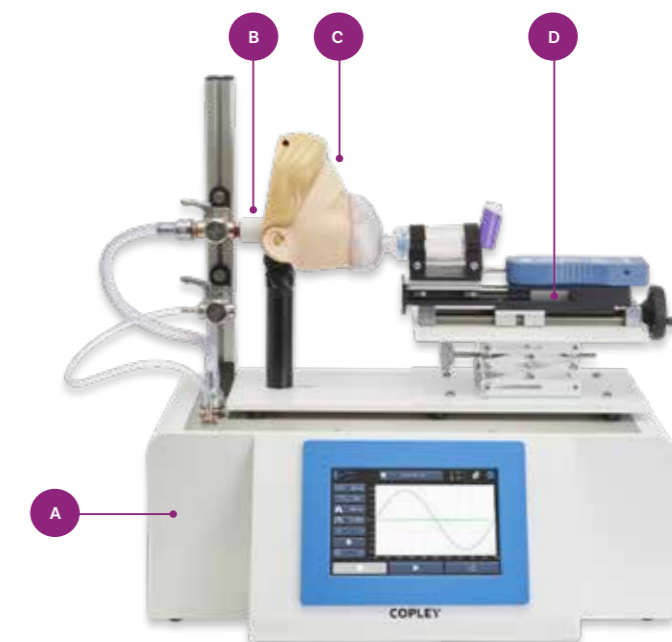

Products Featured in this System



Facemask Testing Apparatus FMA

The FMA is designed to meet all the critical requirements for assessing the impact of facemasks on performance of MDIs with a spacer/VHC.

In addition to the above, the following is needed to complete a fully-operational DDU test system for assessing the impact of facemasks on the performance of MDIs with a Spacer/VHC:

Face Model

Models are available for all age groups - adult, child and infant. All models are fitted with replaceable face skins which provide flexibility and elasticity similar to real life tissue.



Filter Holder & Adapter

Positioned in the cavity behind the lips of the face model, the holder contains a filter to capture the active drug from the device under test. See page 25 for further information.

Breathing Simulator BRS

Providing breathing profiles that are more clinically representative than a constant flow rate, the Breathing Simulator BRS 200i is ideal for assessing the impact of a facemask on the DDU of MDIs with a spacer/VHC. Alternatively, a basic entry-level model, the Breathing Simulator BRS 100i, is also available.

Find out more about our range of Breathing Simulators on page 156.



FMA: APSD Measurement

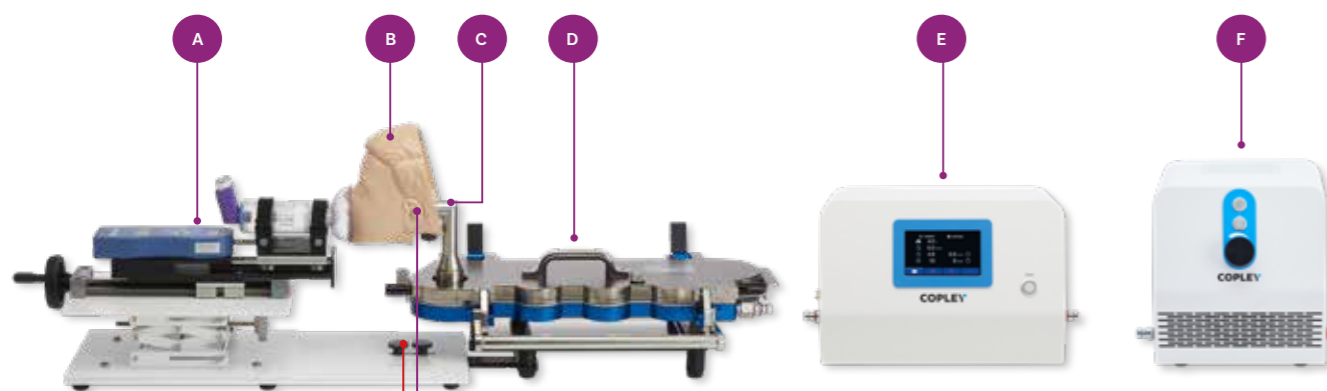

FMA to NGI Interface Accessory

Please note – the FMA to NGI Interface Accessory is a combination of the base attachment (red line) and the white attachment interface shown in the pop-out bubble.



- A Facemask Apparatus FMA
- B Face Model
- C Induction Port
- D Cascade Impactor
- E Flow Controller
- F Vacuum Pump

Facemask Testing Apparatus FMA

Cat. No.	Description
9154	Adult/Child Head to NGI Induction Port Adapter
9155	FMA/FMS to NGI Interface Accessory
9157	Flow Meter Adapter for Adult/Child Head

Products Featured in this System



Facemask Testing Apparatus FMA

The FMA is designed to meet all the critical requirements for assessing the impact of facemasks on the performance MDIs with a spacer/VHC.

In addition to the above, the following is needed to complete a fully-operational APSD measurement set-up for testing the performance of MDIs with a Spacer/VHC when used with a facemask.

Face Model

Models are available for all age groups - adult, child and infant. All models are fitted with replaceable face skins which provide flexibility and elasticity similar to real life tissue.



Filter Holder & Adapter

Positioned in the cavity behind the lips of the face model, the holder contains a filter to capture the active drug from the device under test.

See page 25 for further information.



Next Generation Impactor NGI

The APSD characterisation of facemask performance should be conducted using an NGI.

See page 84 for further information.

FMA to NGI Interface Accessory

Provides a direct connection between the FMA and Face Model which is mounted onto the inlet of the NGI Induction Port.



Flow Controller

Suitable for setting flow rate and sampling time delays, as well as controlling inhaled volume, our range of Flow Controllers improve testing reproducibility and the ease of method transfer, reducing potential sources of data variability.

See page 172 for further information about Flow Controller Range.

Flow Rate Sensor FRS

Used for establishing accurate and consistent inlet flow rate during testing.

See page 184 for further information about flow rate measurement.



Vacuum Pump

Our Vacuum Pump range represents the latest in high performance, low maintenance, technology, and is specifically designed for use in the testing of OINDPs.

See page 188 for further information about our Vacuum Pump range.

Qualification

GMP regulations require that

- The test methods used to monitor pharmaceuticals must meet proper standards of accuracy and reliability
- Companies should establish procedures to ensure the fitness for use of instruments that generate data supporting product testing



Copley provides a range of qualification documentation, services and tools to meet these requirements.

See page 324 for further information.

2. Facemask Testing Stand FMS for Nebulisers

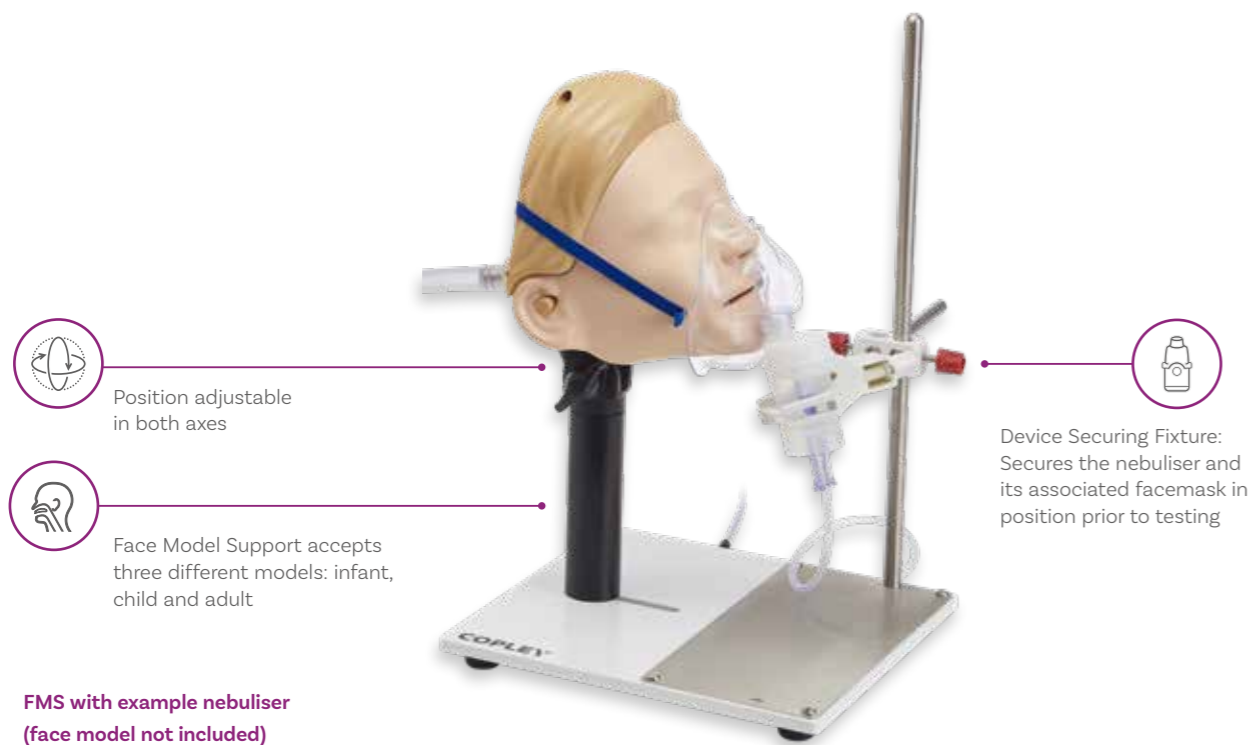

FMS with example nebuliser (face model not included)

Facemask Testing Stand FMS

Cat. No.	Description
9156	Facemask Stand for Nebulisers Model FMS
9142	FMA/FMS Filter Holder and Adapter for BRS 100i
9143	FMA/FMS Filter Holder and Adapter for BRS 200i/300i

FMS: DDU Testing

- A Breathing Simulator
- B Face Model
- C Facemask Stand (FMS)

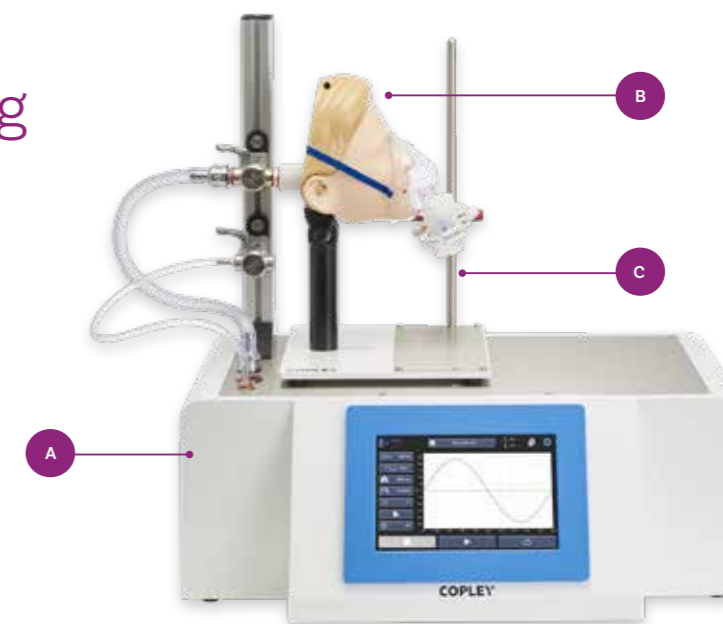

Products Featured in this System



Facemask Stand FMS

The FMS is designed to meet all the critical requirements for assessing the effect of facemasks on the use of nebulisers.

In addition to the above, the following is needed to complete a fully-operational DDU test system for assessing the impact of facemasks on nebuliser performance:

Face Model

Models are available for all age groups - adult, child and infant. All models are fitted with replaceable face skins which provide flexibility and elasticity similar to real life tissue.



Filter Holder & Adapter

Positioned in the cavity behind the lips of the face model, the holder contains a filter to capture the active drug from the device under test. See page 25 for further information.

Breathing Simulator BRS

Providing breathing profiles that are more clinically representative than a constant flow rate, the Breathing Simulator BRS 200i is ideal for assessing the impact of a facemask on the DDU of nebulisers. Alternatively, a basic entry-level model, the Breathing Simulator BRS 100i, is also available.

Find out more about our range of Breathing Simulators on page 156.



FMS: APSD Measurement

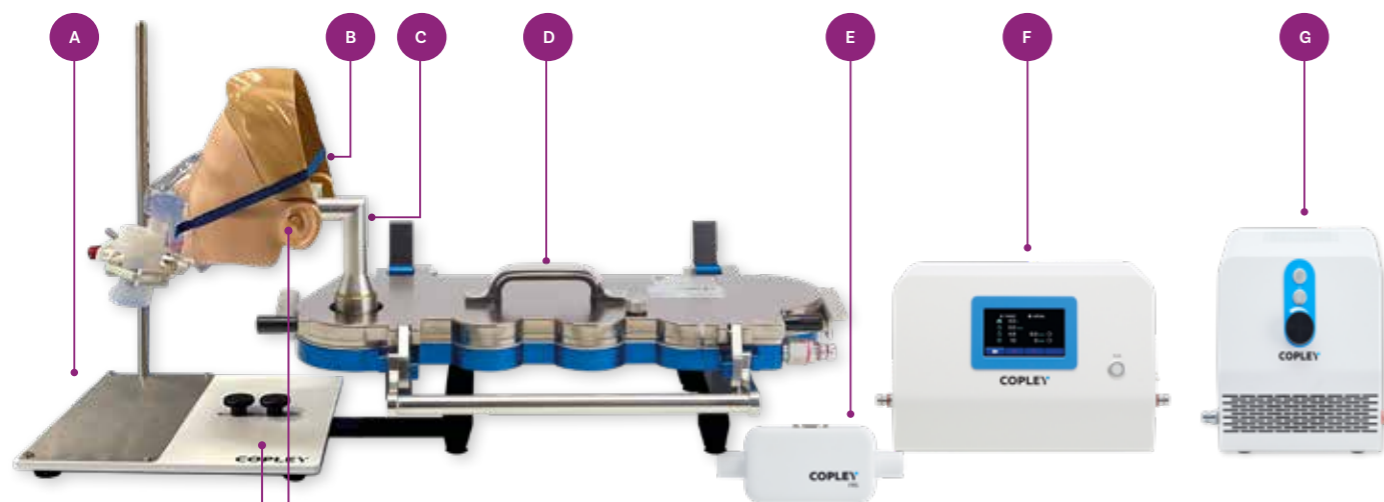

FMA to NGI Interface Accessory

Please note - the FMA to NGI Interface Accessory is a combination of the base attachment (red line) and the white interface attachment shown in the pop-out bubble.

- A Facemask Stand FMS
- B Face Model
- C Inducton Port
- D Cascade Impactor
- E Flow Rate Sensor FRS
- F Flow Controller
- G Vacuum Pump

Products Featured in this System



Facemask Stand FMS

The FMS is designed to meet all the critical requirements for assessing the effect of facemasks on the use of nebulisers.

In addition to the above, the following is needed to complete a fully-operational APSD measurement system for assessing the impact of facemasks on nebuliser performance:

Face Model

Models are available for all age groups - adult, child and infant. All models are fitted with replaceable face skins which provide flexibility and elasticity similar to real life tissue.



Filter Holder & Adapter

Positioned in the cavity behind the lips of the face model, the holder contains a filter to capture the active drug from the device under test.

See page 25 for further information.

Next Generation Impactor NGI

The APSD characterisation of a nebuliser should be conducted using an NGI, because it has calibrated performance at the 15 L/min test rate specified for nebulisers.

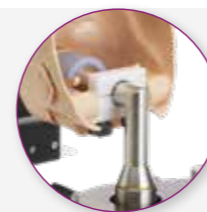

FMS to NGI Interface Accessory

Provides a direct connection between the FMS and Face Model that is mounted onto the inlet of the NGI Induction Port.

Flow Rate Sensor FRS

Used for establishing accurate and consistent inlet flow rate during testing. See page 184 for further information about flow rate measurement.



Flow Controller

Suitable for setting flow rate and sampling time delays, as well as controlling inhaled volume, our range of Flow Controllers improve testing reproducibility and the ease of method transfer, reducing potential sources of data variability. See page 172 for further information about Flow Controller Range.



Vacuum Pump

Our Vacuum Pump range represents the latest in high performance, low maintenance, technology, and is specifically designed for use in the testing of OINDPs.

See page 188 for further information about our Vacuum Pump range.



TOP TIP



The NGI Cooler™ can only be used for nebulisers with mouthpieces. For nebulisers with facemasks the NGI will need to be removed from the NGI Cooler for testing, once the required temperature has been reached.

Qualification

GMP regulations require that

- The test methods used to monitor pharmaceuticals must meet proper standards of accuracy and reliability
- Companies should establish procedures to ensure the fitness for use of instruments that generate data supporting product testing

Copley provides a range of qualification documentation, services and tools to meet these requirements.

See page 324 for further information.



Morphology

Cascade impactors separate the delivered dose from an inhaled product on the basis of particle inertia, producing sized fractions which are then subject to chemical assay to produce an APSD for the active drug.

Whilst this process provides a useful indication of where inhaled drug particles are likely to deposit within the respiratory tract, it does not profile the morphological properties of these particles. Generating component specific particle geometric size and shape data may be helpful in understanding differences between formulations and hence their potential bioavailability,

even when APSDs are equivalent. This can be particularly useful in generic development when trying to replicate the performance of a reference product. The Malvern Glass Disc Cup, allows for collection of particles on a quartz glass disk, which can then be transferred to a Malvern Panalytical Morphologi 4-ID or equivalent system for morphological analysis.



Morphology Sampling Apparatus

Cat. No.	Description
5242A	Malvern Glass Disc Cup, Small (for Morphologi 4-ID system)

Cold Freon® Effect

The cold Freon® effect is the inadvertent reaction to the chilling sensation at the back of the throat following the actuation of MDIs, and it can significantly influence the efficiency of drug delivery. For example, the effect may cause the patient to cough, or abort the inhalation manoeuvre, resulting in inconsistent dose delivery.

Spray pattern and plume geometry are common measurement techniques employed by the pharmaceutical industry to characterise the emitted spray from MDIs and nasal sprays. However, the reaction of the user to the impaction force of the spray on the throat or nasal passageways is also of much concern.

TOP TIP The 'cold Freon®' effect is a function of aerosol spray force and plume temperature.

TOP TIP Cold Freon® effect assessment is important in switching propellants for MDIs. For example, reformulation of CFC to HFA 134a and HFA 152a.

Novel Inhaled Formulations

Assessing the cold Freon® effect of a new MDI or nasal formulation is valuable in evaluating and minimising the potential for any unintended reaction by the patient which may impede drug delivery. Assessing the spray force and plume temperature of a given formulation when actuated as per the manufacturer's instructions can give a good indication of whether either of these parameters may induce an adverse reaction by the patient when used in real life.

Generic Inhaled Formulations

An assessment of the cold Freon® effect of generic formulations can also provide useful supportive evidence for the demonstration of BE. Comparative measures of impaction force and temperature are a good indicator of local delivery equivalence, or otherwise, and help to confirm that in clinical use the generic will be interchangeable with the reference product. Since velocity is directly related to the impaction force and temperature, the latter should be a good indicator of local delivery equivalence for an inhaled drug.

Copley offers two types of test apparatus to assess cold Freon®.



Spray Force Tester



Plume Temperature Tester



Drug A and Drug B demonstrate bioequivalence *in vitro*, however, differences in their cold Freon® characteristics may cause differences in *in vivo* performance



Spray Force Tester SFT 1000

Offering high precision impaction force testing for MDIs and nasal sprays, the Spray Force Tester SFT 1000 provides analysts with a simple and reliable way of assessing the effects of cold Freon® on the throat and nasal cavity over the duration of the spray plume.



High sensitivity digital load cell



Pass/Fail alarms for user-programmable limits (for QC)



Memory capability for up to 100 spray force measurements



Load cell calibration verification easily performed by user

Key Features:

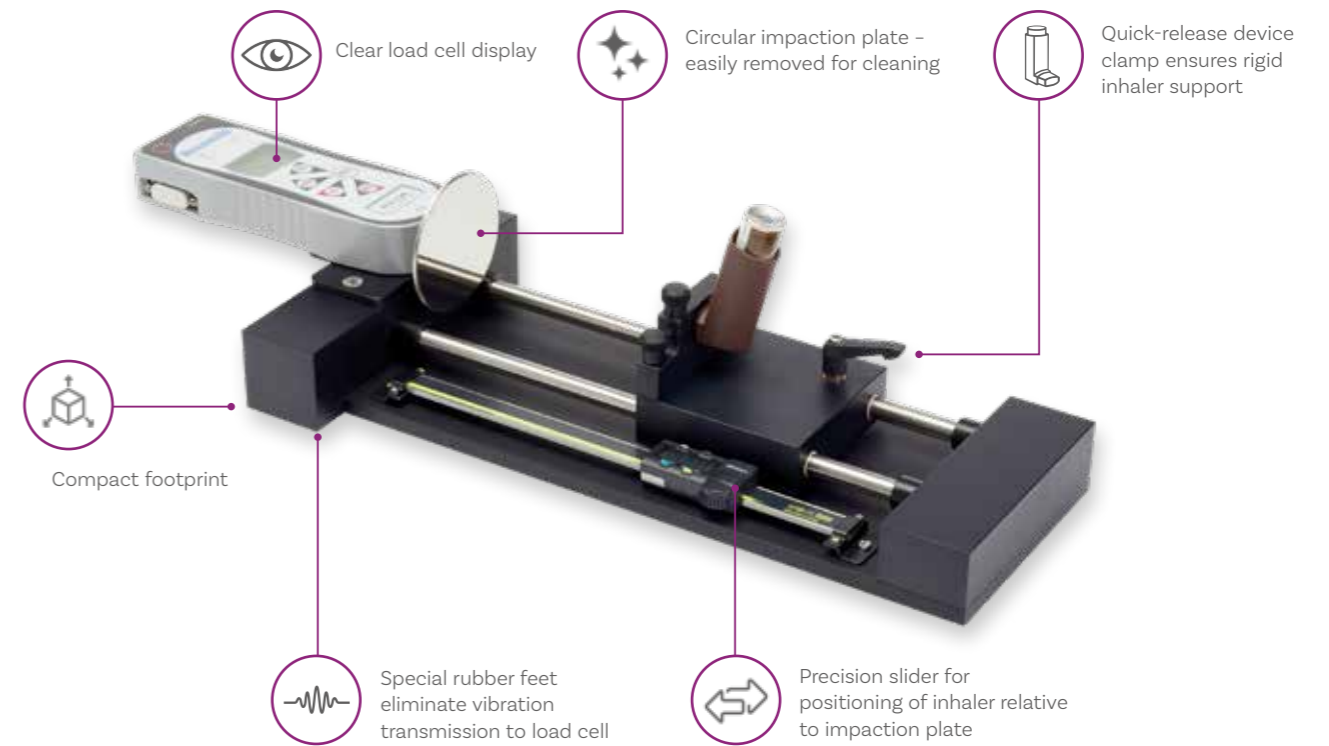

A sample of the inhaler to be tested is required at the time of placing an order so that a customised clamp can be made.

SFT 1000: Technical Specifications

Flow Rate Range	0 to 2500 mN
Accuracy	+/-2.5 mN
Adjustable Distance	The distance of the device relative to the impaction plate can be adjusted between 0 and 200 mm +/-0.03 mm using the precision digital gauge.
Power	Battery or mains powered
Dimensions (l x w x h)	580 x 200 x 80 mm
Reporting	RS-232 output to computer or printer



Supplied complete with calibration certificates for load cell and gauge

Spray Force Tester SFT 1000

Cat. No.	Description	Cat. No.	Description
9000	Spray Force Tester Model SFT 1000	9005	Digital Mini Processor (Statistical Printer)
9001	Additional Device Clamp	9006	IQ/OQ Documentation for SFT 1000
9002	Re-calibration of Spray Force Load Cell	9007	Qualification Tools for SFT 1000
9003	Re-calibration of Digital Gauge	9008	Re-calibration of SFT 1000 Qualification Tools
9004	Spare Impaction Plate		

Special Applications

We offer a range of specialised test equipment for specific applications relating to the performance assessment of orally inhaled and nasal drug products (OINDPs).

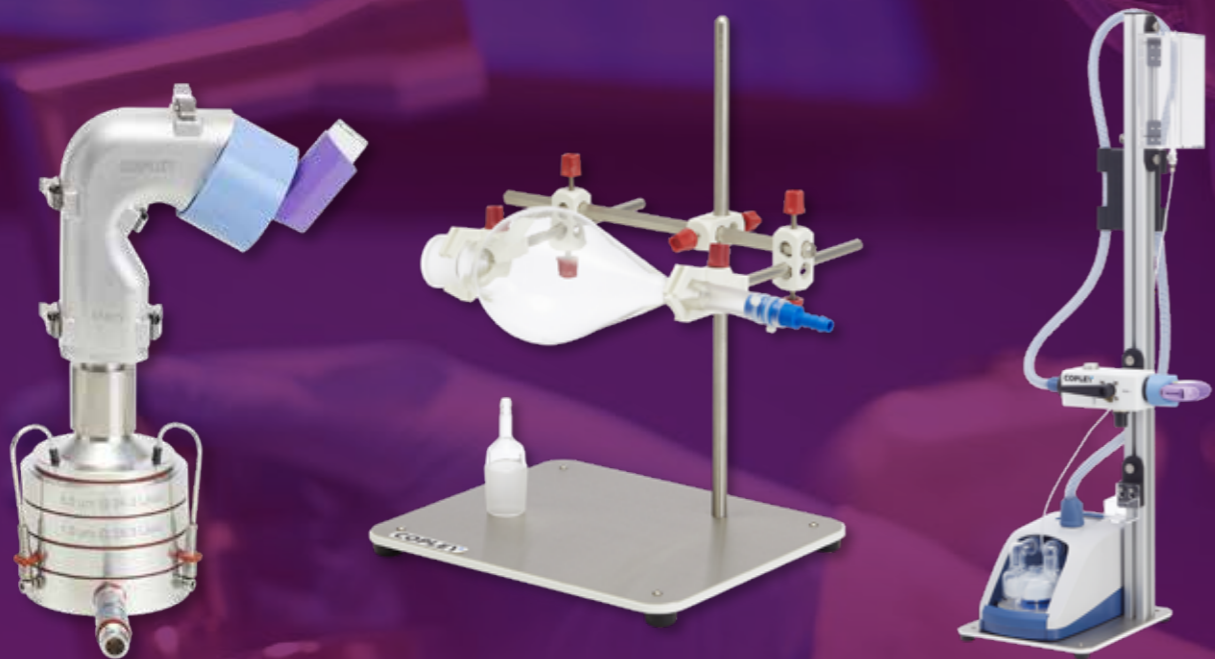

Abbreviated Impactor Measurement AIM

The drive for greater efficiency is stimulating debate as to whether full-resolution, multiple-stage cascade impaction can be supplemented with AIM as part of a Quality by Design (QbD) process.

Once the full APSD profile of a product has been established, AIM may be useful as a rapid screening tool in R&D and, with the use of appropriate metrics, in QC applications also.

We also offer a tool that enables analysts to match the flow resistance and flow rate rise-time profiles between a full resolution impactor and its abbreviated counterpart to ensure comparable conditions for aerosol generation, supporting improved equivalence in aerodynamic particle sizing measurements.

See page 265 for further information.

Generic Drug Development

There is growing interest in the development of generic orally inhaled products (OIPs) as the patents on the original products expire. This has led to the reintroduction into the pharmacopoeias of some of the test methods employed in the development of the original drug products.

See page 274 for further information.

Device Robustness/Inhaler Misuse

Device mishandling and poor technique are widely recognised issues associated with the use of inhalers, resulting in inadequately controlled respiratory disease and an over-reliance on emergency remedies.

We offer solutions to aid those developing inhaled drug devices and products in understanding the impact of poor patient technique on the critical quality attributes (CQAs) of inhalers to help optimise inhaler designs for more robust drug delivery.

See page 280 for more information.

Abbreviated Impactor Method AIM

Background

Due to the unique nature of their part device/part formulation, the practical application of QbD principles to OINDPs is not easy.

The preferred and current instrument of choice for measuring the aerodynamic particle size distribution (APSD) of OIPs for both regulators and pharmacopoeias is the cascade impactor (see page 84). Whilst providing a detailed size classification of the aerosol cloud concerned, recent QbD initiatives have highlighted that full resolution multi-stage cascade impaction

methods may not only be time-consuming but also require a high degree of skill and consistency on the part of the analyst if error is to be avoided.

For these reasons and with the adoption of QbD potentially increasing demands for analytical data, attention has turned to the concept of AIM.

AIM in QC

For OIP product batch release testing and QC applications, it is possible to use simpler but highly sensitive metrics to determine if the product is fit for

purpose once a full APSD profile has been established using a full-resolution cascade impactor. This is known as Efficient Data Analysis (EDA).

Typically, the APSDs of inhaled products exhibit a Normal (or Gaussian) Distribution centred around the Mass Median Aerodynamic Diameter (MMAD). It is therefore possible to determine even subtle changes in the APSD by measuring the following:

- 1. Impactor Sized Mass (ISM):** the sum of the drug mass deposited on the filter and all impactor stages where the upper-bound size of entering particles is known. This metric indicates any shift in the amplitude of the APSD.
- 2. Ratio of Large Particle Mass to Small Particle Mass (LPM/SPM):** determined by splitting the ISM into two fractions on either side of the MMAD: LPM greater than the MMAD and SPM smaller than the MMAD. This ratio indicates any shift in the central tendency of the APSD.

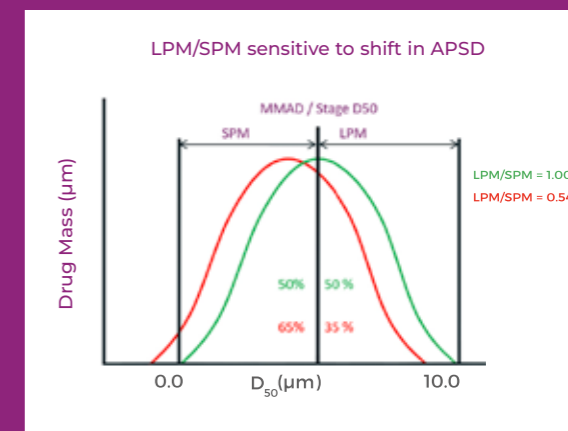

Although EDA can be applied to full-resolution impactor testing, its true value comes from combining it with AIM, which uses only a reduced number of impactor stages, speeding up throughput and further reducing analytical error. Full-resolution impactor testing is then reserved for out-of-specification (OOS) investigations.

In this diagram, the AIM-QC model shows how abbreviating the ACI to just 2 stages and a filter, with the central stage (Stage X) selected to have a cut-off diameter close to the product MMAD allows the EDA metrics of ISM and LPM/SPM to be easily determined.

The table on page 92 indicates which stage can be used for Stage X.

Adapted from: Mitchell, J.P. et al. Relative Precision of Inhaler Aerodynamic Particle Size Distribution (APSD) Metrics by Full Resolution and Abbreviated Andersen Cascade Impactors (ACIs): Part 1, AAPS PharmSciTechnol., 2010, 11(2): 843-851

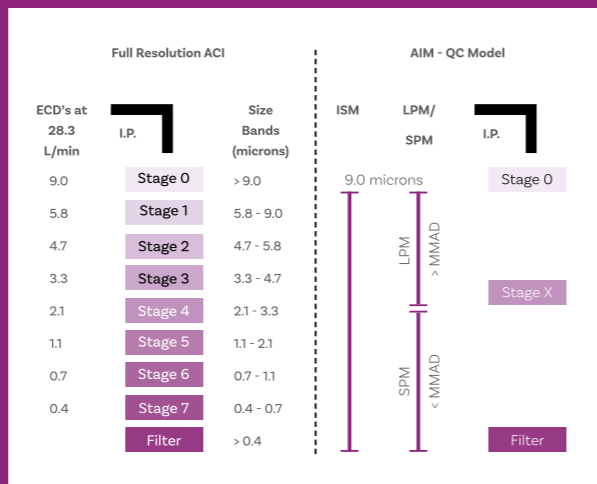

AIM in R&D

AIM has also been suggested as a useful tool in R&D for the fast screening of new formulations in product development.

An important aim is to establish how to generate clinically representative data to reduce the dependence on time-consuming and expensive clinical trials.

This is not easy; as has been mentioned before, a cascade impactor is not analogous to the lung. The lung is a complex organ, with high humidity, decreasing velocity with each bifurcation and complex deposition mechanisms (diffusion and sedimentation, as well as impaction). This makes correlation between *in vitro* cascade impactor measurements and deposition in the Human Respiratory Tract (HRT) highly complex.

There is some evidence to suggest that abbreviated versions of full stack cascade impactors can be used to broadly indicate *in vivo* lung deposition based on two or three size bands (or fractions):

- 1. Coarse Particle Mass (CPM)** – That portion of the aerosol considered to be too large to be inhaled (usually considered to be >5 microns).
- 2. Fine Particle Mass (FPM)** – That portion between 5 and 1 micron, usually considered likely to deposit deep into the lung and hence be therapeutically effective.
- 3. Extra-fine Particle Mass (EPM)** – That portion below 1 micron, usually considered to be too small to deposit in the lung and potentially exhaled.

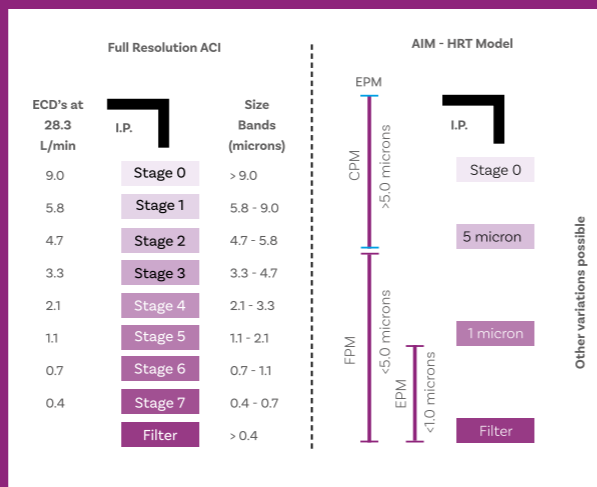

Adapted from: Mitchell, J.P. et al. Relative Precision of Inhaler Aerodynamic Particle Size Distribution (APSD) Metrics by Full Resolution and Abbreviated Andersen Cascade Impactors (ACIs): Part 1, AAPS PharmSciTechnol., 2010, 11(2): 843-851

AIM - The Future

To meet these various demands and to provide a basis for the proof-of-concept work necessary to validate them, Copley has introduced a number of different versions of abbreviated impactor for use in both QC (QC Models) and R&D (HRT Models). These are based on stage versions of the popular Andersen Cascade Impactor (ACI) and Next Generation Impactor (NGI).

If validated and implemented, these impactors could help to speed up formulation screening, prior to full resolution impactor studies being performed on the most promising candidates and then subsequent used for product release in QC.

Fast Screening Andersen FSA

FSA is an AIM version of the standard ACI suitably modified to provide a reduced stack plus filter (F) suitable for either:



Quality Control (FSA-QC)

Stages 0 (or -1, or -2A) and F are used in conjunction with a Stage X, with a cut-off diameter as close as possible to the MMAD of the aerosol, as determined during full resolution cascade impactor testing.

Product Development (FSA-HRT) with Realistic Throat and Nasal Models

Stages with cut-off diameters are available at 5.0 and 1.0 microns for metered-dose inhaler (MDI) applications at 28.3 L/min. Also, for this and higher flow rates (60 and 90 L/min) stages having traditional ACI cut points of 4.7 and 1.1 microns are available, primarily for dry powder inhaler (DPI) applications.

Find out more about our Realistic Throat and Nasal products on page 232.



In addition to the FSA, the following ancillaries are required to complete a fully operational test set-up for determining the CPM, FPM, EPM, or LPM/SPM ratio:



Vacuum Pump

See page 188.

Critical Flow Controller

For DPI testing only
See page 172.

Flow Rate Sensor FRS

See page 184.

Mouthpiece Adapter

See page 214.

FSA-QC with Stage X cut-off diameter close to product MMAD

Cat. No. Description

- 8341** FSA-QC - 28.3 L/min (Stages 0, X and F)*
- 8342** FSA-QC - 60.0 L/min (Stages -1, X and F)*
- 8343** FSA-QC - 90.0 L/min (Stages -2A, X and F)*

FSA-HRT with cut-off diameters of 5.0 and 1.0 or 4.7 and 1.1 microns

- 8344** FSA-HRT - 28.3 L/min (Spacer, Stages 5.0 and 1.0 micron, and F)*
- 8345** FSA-HRT - 28.3 L/min (Spacer, Stages 2, 5 and F)*
- 8346** FSA-HRT - 60.0 L/min (Spacer, Stages 1, 4 and F)*
- 8347** FSA-HRT - 90.0 L/min (Spacer, Stages -0, 4 and F)*

Induction Ports

- 8501** USP Induction Port*
- 8510** USP Induction Port (One-piece 316 Stainless Steel)
- 8060** Flow Meter to Induction Port/WSC2 Adapter
- 5239** FRS Flow Meter Adapter
- 5238** DFM Flow Meter Adapter

Preseparators for testing DPIs

- 8401** 28.3 L/min Preseparator*
- 8420** 60 L/min Preseparator*
- 8420-90** 90 L/min Preseparator*

Spare Parts

- 8367-I** Stage 5.0 micron cut-off @ 28.3 L/min*
- 8368** Stage 1.0 micron cut-off @ 28.3 L/min*
- 8371** FSA Spacer Stage*
- 8334** Complete Set of 7 Silicone Rubber O-Rings
- 8335** Set of 2 Stainless Steel Collection Plates (28.3 L/min)
- 8336** Set of 2 Stainless Steel Collection Plates (60 or 90 L/min)
- 8316** Box of 100 Glass Fibre Filters
- 8308A** Set of 3 Shortened Spring Clamps - 4 Stage
- 8308B** Set of 3 Shortened Spring Clamps - 3 Stage

*Please specify Aluminium (A), 316 Stainless Steel (S) or Titanium (T) when placing your order.

Reduced NGI rNGI

The individual stages of the NGI are fixed within the seal body, such that they cannot be removed. However, the NGI can be used in an abbreviated form, the rNGI, for both AIM-QC and AIM-HRT applications.

As with the FSA, and depending on the flow rate to be used, a stage between 2 and 4 (see blue highlights in the table below) of the NGI can be selected with a cut-off diameter close to the product's MMAD (AIM-QC application) or close to 5 microns (in the case of an AIM-HRT application).

The rNGI Filter Holder Assembly is placed in the stage immediately after the cut-off stage selected.

It consists of a filter support mesh which is placed on top of the stage nozzles and a split ring used to hold the filter in position on top of the filter support mesh.

When operating the rNGI, particles smaller than the cut-off diameter of the stage preceding the rNGI Filter Holder Assembly will be captured on the paper filter of the rNGI, whilst particles larger than the cut-off diameter will impact as normal in the collection cups of those stages upstream.

Note: when using the rNGI Filter Holder Assembly, it is not possible to have a second stage representing the Extra-fine Particle Mass (EPM).

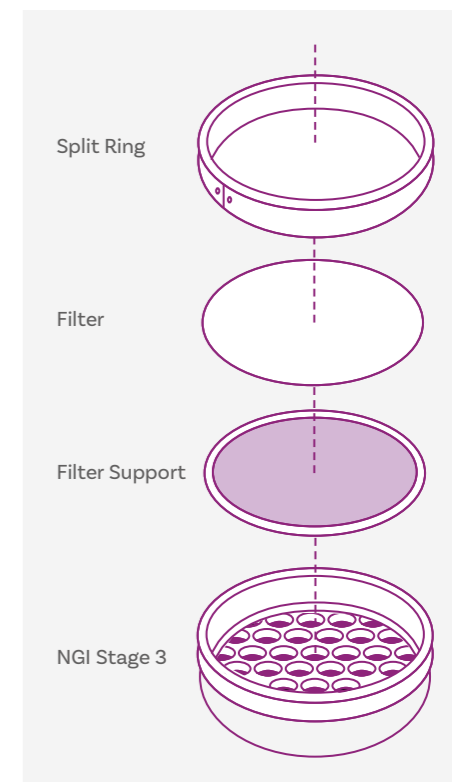

rNGI

- 5259** rNGI Filter Holder Assembly
- 5259A** Pack of 100 Filters

Stage Cut-off Diameters for the NGI at Different Flow Rates										
		Flow Rate (L/min)								
		15	30	40	50	60	70	80	90	100
Stage	1	14.10	11.72	10.03	8.89	8.06	7.42	6.90	6.48	6.12
	2	8.61	6.40	5.51	4.90	4.46	4.12	3.84	3.61	3.42
	3	5.39	3.99	3.45	3.09	2.82	2.61	2.44	2.30	2.18
	4	3.30	2.30	2.01	1.81	1.66	1.54	1.45	1.37	1.31
	5	2.08	1.36	1.17	1.04	0.94	0.87	0.81	0.76	0.72
	6	1.36	0.83	0.70	0.61	0.55	0.50	0.46	0.43	0.40
	7	0.98	0.54	0.45	0.38	0.34	0.31	0.28	0.26	0.24



The rNGI Filter Holder Assembly should be placed in the stage immediately after the stage with the desired cut-off diameter.

Fast Screening Impactor FSI

Based on proven NGI Preseparator technology, the FSI represents a purpose-made approach to AIM that separates the dose into CPM and FPM making it suitable for AIM-HRT applications (i.e. FSI-HRT) for MDIs, DPIs and nasal sprays.

A range of inserts are available, to generate a 5 micron cut-off diameter within the flow rate range of 30-100 L/min at 5 L/min intervals. This makes the FSI ideal for DPIs tested at a flow rate that equates to a 4 kPa pressure drop over the inhaler.

The FSI uses the same induction port as the NGI. It employs a two-stage separation process in which first large non-inhalable boluses are captured in a liquid trap followed by a fine-cut impaction stage at 5 microns. This gives unparalleled accuracy, high capacity, low internal losses and low carryover.

The fine particle dose is collected on a glass fibre filter located in an external filter holder with quick-release catches for easy access.

An additional insert is available for generating a 10 micron cut-off diameter at 30 L/min. When used with a Glass Expansion Chamber (see page 208) this makes the FSI ideal for the fast screening of nasal aerosols and sprays.



Fast Screening Impactor FSI



Interchangeable Inserts



Filter Holder

In addition to the FSI, the following ancillaries are required to complete a fully operational test set-up for determining the CPM, FPM, or LPM/SPM ratio:



Vacuum Pump
See page 188.



Critical Flow Controller
For DPI testing only
See page 172.



Flow Rate Sensor
See page 184.



Mouthpiece Adapter
See page 214.



Glass Expansion Chamber
For Nasal Spray testing only. See page 208.

Fast Screening Impactor FSI complete

Cat. No.	Description
5260	FSI complete with one insert (please specify flow rate - see below)
5261	Additional Inserts - 5 microns @ 30, 35, 40, 45, 50, 55, 60, 65, 70, 75, 80, 85, 90, or 100 L/min for MDIs or DPIs (please specify flow rate)
5240	Box of 100 Filters (for Fine Fraction Collector)

Fine Fraction Collector for users that already have NGI Preseparator

5262	Fine Fraction Collector only Note: For a complete system, users must also purchase an insert (see 5261) to replace the existing insert in their preseparator
------	-----------------------------------------------------------------------------------------------------------------------------------------------------------------

Accessories for MDIs and DPIs

5203	NGI Induction Port
5239	FRS Flow Meter Adapter
5238	DFM Flow Meter Adapter
5204	NGI Preseparator

Accessories for Nasal

5263	Additional Insert - 10 microns @ 30 L/min for Nasal Sprays
------	------------------------------------------------------------

Volume and Resistance Compensator VRC

Patent Pending



Abbreviated impactors are designed to help reduce the burden of full resolution cascade impaction studies, following proper aerodynamic particle size distribution (APSD) profiling.

However, differences in total volume and flow resistance between a full resolution cascade impactor and its abbreviated counterpart is known to cause variability in the flow rate rise-time profiles between the two test set-ups. This difference reduces parity between test conditions, especially for passive, dry powder inhalers (DPIs) where start-up kinetics can be important.

The Volume and Resistance Compensator (VRC) enables analysts to match the flow resistance and flow rate rise-time profiles between the two test set-ups to ensure comparable conditions for aerosol generation, supporting improved equivalence in aerodynamic particle sizing measurements.

Key Features:



Suitable for use with all types of abbreviated impactors



Designed using Copley expertise



Easily adjustable for different set-ups



Ensures parity between test methods, improving data comparability

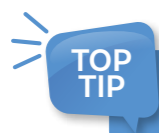

Volume and flow resistance can be independently varied for precise flow rate rise-time matching.



The VRC connects inline between a critical flow controller and an abbreviated impactor.

Shown here (L to R): Fast Screening Impactor (FSI), Volume and Resistance Compensator (VRC), Critical Flow Controller (TPK 100i-R) and High Capacity Vacuum Pump (HCP7).

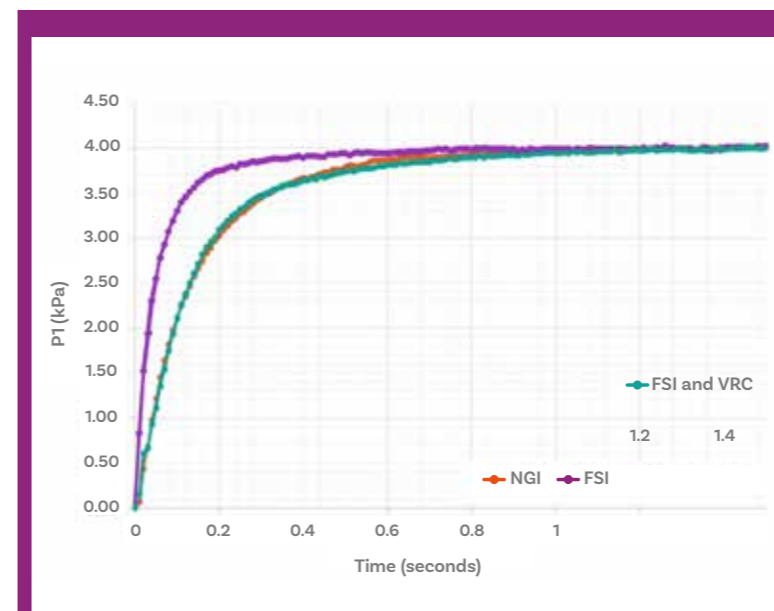

VRC Performance

This graph demonstrates how the NGI rise-time can be closely matched using the VRC with the FSI.

The purple line is the rise-time line with the FSI only.

The orange line is the rise-time with the NGI only.

The green line is the rise-time with both the FSI and VRC.

The VRC was adjusted to first match the flow resistance of the NGI, then the volume was adjusted to match the rise-time.

Volume and Resistance Compensator VRC

Cat. No.	Description
5280	VRC - Volume and Resistance Compensator

Special Applications

Generic Drug Development

The success of a generic drug formulation submission relies on the robust demonstration of bioequivalence (BE) to a reference labelled drug (RLD). This normally involves the provision of *in vitro* data to demonstrate that the generic will perform in a clinically identical way to the RLD.

The FDA regularly issue product-specific guidance for several active pharmaceutical ingredients (APIs) that are used globally for the treatment of asthma and COPD and are consequently routine targets for generic development. The USP also have introduced product-specific monographs for Fluticasone Propionate (FP) and Salmeterol.

A further monograph for Albuterol Inhalation solution products has been approved.

The product-specific monographs concerned covered both DDU testing and APSD measurements. DDU and APSD are required performance metrics for all OIPs because of their defining influence on the success and consistency of drug delivery.

The original product-specific monographs called for the use of test equipment based on methods used in the original development of these products.

The USP listed four such monographs for FP and FP/Salmeterol combination products:

- Two relate to the use of the APIs as aerosols delivered by an MDI
- Two are for APIs prepared as inhalation powders for delivery by a DPI

Fluticasone Propionate/Salmeterol Aerosols & Powders

The inhalation powder monographs require that DDU measurements be conducted for a duration consistent with the withdrawal of 2 litres of air. This volume is generally considered to be representative of a typical patient with asthma or COPD.



APSD measurement was originally conducted using a standard ACI equipped with a specially modified induction port common to both aerosols and powders and a specially modified inlet cone and preseparator for aerosols and powders respectively.

According to the monographs, the 28.3 L/min version of the ACI (Stages 0 to 7 plus filter stage) was used to measure APSD for both aerosols and powders despite the fact that the powder method specifies testing at 60 L/min.

The duration of testing for APSD measurements is adjusted to give the volumetric equivalent of 3 litres of air. This is likely due to the need to achieve adequate volume changes in the ACI.

FP/Salmeterol Aerosols

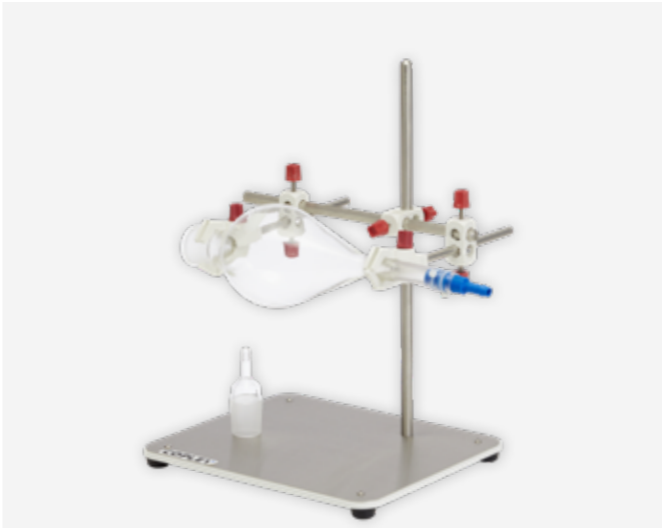
Apparatus requirements:

Delivered Dose Uniformity	Aerodynamic Particle Size Distribution
 <p>Sample Collection Apparatus for FP/Salmeterol Aerosols</p>	 <p>Andersen Cascade Impactor (ACI)</p>
-	FP/Salmeterol Induction Port
-	ACI Inlet Cone for FP/Salmeterol Aerosols

FP/Salmeterol Powders

Apparatus requirements:

Delivered Dose Uniformity

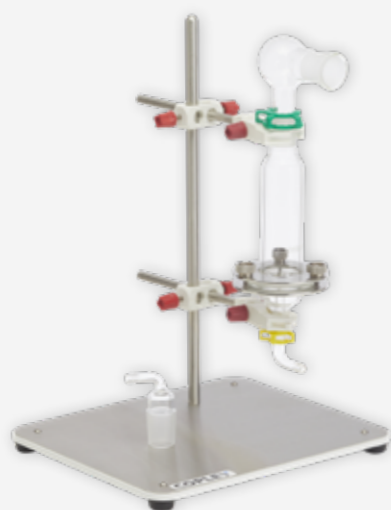

Sample Collection Apparatus for FP/Salmeterol Powders

-

-

-

Aerodynamic Particle Size Distribution



Andersen Cascade Impactor (ACI)

FP/Salmeterol Induction Port

ACI Preseparator for FP/Salmeterol Powders

ACI Inlet Cone for FP/Salmeterol Aerosols

In addition to the above and previous page, the following are recommended to complete a fully-operational test set-up for the DDU testing and APSD measurement of **FP/Salmeterol Aerosols & Powders**.

			
Vacuum Pump See page 188.	Critical Flow Controller For DPI testing only See page 172.	Flow Rate Sensor FRS See page 184.	Mouthpiece Adapter See page 214.

Apparatus for DDU testing of FP/Salmeterol Products

Cat. No.	Description
8646	Sample Collection Apparatus for FP/Salmeterol Aerosols
8640	Sample Collection Apparatus for FP/Salmeterol Powders

Spare Parts for Sample Collection Apparatus for Aerosols

8649	Pack of 500 Cotton Wool Balls
8647	Separating Flask
8648	Flow Meter Adapter
8650	Vacuum Pump Adapter

Spare Parts for Sample Collection Apparatus for Powders

8641	Pack of 100 Glass Fibre Filters 70 mm
8903	Throat
8642	Upper Chamber
8643	Lower Chamber
8610	Stainless Steel Filter Support Disc
8645	Clamp Assembly
8909	Flow Meter Adapter
8910	Vacuum Pump Adapter
8644	Spare Set of Glassware (complete)

Apparatus for APSD testing of FP/Salmeterol Products

8372	ACI Inlet Cone for FP/Salmeterol Aerosols*
8405	ACI Preseparator for FP/Salmeterol Powders*
8406	Set of 2 O-rings for FP/Salmeterol ACI Preseparator (Spare)
8505	FP/Salmeterol Induction Port*
8505SW	FP/Salmeterol Induction Port (One-piece 316 Stainless Steel)
8920	FRS Flow Meter Adapter for GTI/FP Ind Port
8506	Flow Meter Adapter for FP/S Induction Port
5401A	FP/Salmeterol ACI Carrying/Wash Rack

* Please specify Aluminium (A) or 316 Stainless Steel (S) when placing your order.

Other

8503	Set of 2 Silicone Rubber Rinsing Caps for FP Induction Port
-------------	-------------------------------------------------------------

Albuterol Inhalation Aerosols

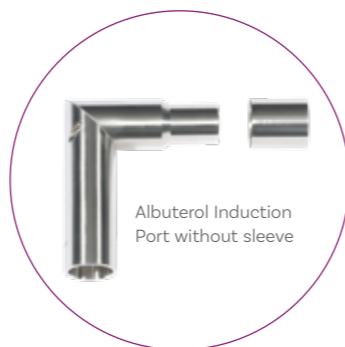

The draft monograph for Albuterol Inhalation Aerosols (Albuterol Inhalation Aerosol In-Process Revision 44(1)) specified a special glass Sample Collection Apparatus to be used for DDU testing (see below).



The original apparatus used a solid plastic firing adapter, instead of a mouthpiece adapter, to accept an inhaler with a circular mouthpiece of corresponding dimensions. Alternatively, a silicone Mouthpiece Adapter (page 214) could be used.

APSD measurement was conducted using a standard ACI equipped with a specially modified induction port. A special Inlet Sleeve is available that slips over the induction port inlet, to enable the induction port to be used with regular mouthpiece adapters used on USP/NGI induction ports.

In addition to the above, the following are recommended to complete a fully-operational test set-up for the DDU testing and APSD measurement of **Albuterol Inhalation Aerosols**.

			
Vacuum Pump See page 188.	Critical Flow Controller For DPI testing only See page 172.	Flow Rate Sensor FRS See page 184.	Mouthpiece Adapter See page 214.

Apparatus for DDU testing of Albuterol Aerosol Products

Cat. No.	Description
8520	Sample Collection Apparatus for Albuterol Aerosol
8524	Glass Wool (1 m length)
8521	Firing Adapter
8522	Flow Meter Adapter



Spare Parts for Sample Collection Apparatus for Albuterol Aerosol

8523	Glassware for Albuterol Aerosol Sample Collection Apparatus
-------------	-------------------------------------------------------------

Apparatus for APSD testing of Albuterol Aerosol Products

8509	Albuterol Induction Port*
8509SW	Albuterol Induction Port (One-piece stainless steel)
8519	Albuterol Induction Port Inlet Sleeve*
8920	FRS Flow Meter Adapter for GTI/FP Ind Port
5238	DFM Flow Meter Adapter

* Please specify Aluminium (A) or 316 Stainless Steel (S) when placing your order.

Delivered Dose Uniformity	Aerodynamic Particle Size Distribution
 <p>Sample Collection Apparatus for Albuterol Aerosol</p> <p>Firing Adapter</p> <p style="text-align: center;">-</p>	 <p>Andersen Cascade Impactor (ACI)</p> <p>Albuterol Induction Port</p> <p>Albuterol Induction Port Inlet Sleeve (optional)</p>



Special Applications Device Robustness/ Inhaler Misuse

Patient Exhalation Simulator PES

It is estimated that between 14-22% of patients exhale into their DPI mouthpiece prior to the inhalation step*. The consequence of this poor technique may be insufficient drug delivery for effective administration and ultimately, inadequately controlled respiratory disease and/or an over-reliance on emergency medication.

The **Patient Exhalation Simulator (PES)** accurately replicates the effects of a patient exhaling into the device mouthpiece prior to the inhalation step. The warm, humid air generated by the PES can be set at flow rates representative of different human exhalation profiles.

The PES enables developers to assess how device misuse impacts the critical quality attributes of the inhaler, empowering device design optimisation to ensure robust drug delivery.

-  Simple to set-up and easy-to-use
-  Adjustable air flow temperature and flow rate
-  Ideal for assessing a range of patient profiles
-  Low maintenance
-  Works with existing Copley mouthpiece adapters
-  Qualification tools are available



Key Features:

Timed exhalations can be performed by directing the air flow to 'Waste' at the start and end of an exhalation simulation

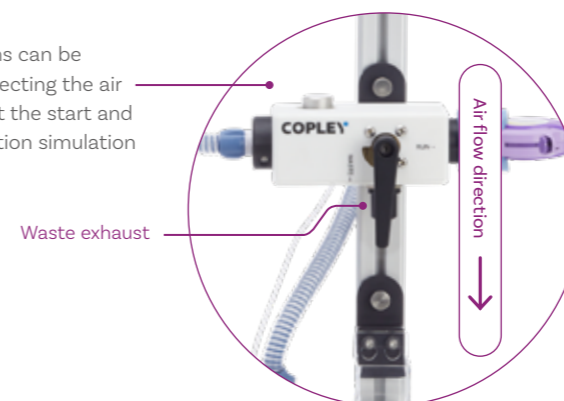

Qualification tools are available for air flow temperature and relative humidity verification



Air flow **temperature** and **flow rate** are adjustable via a digital display

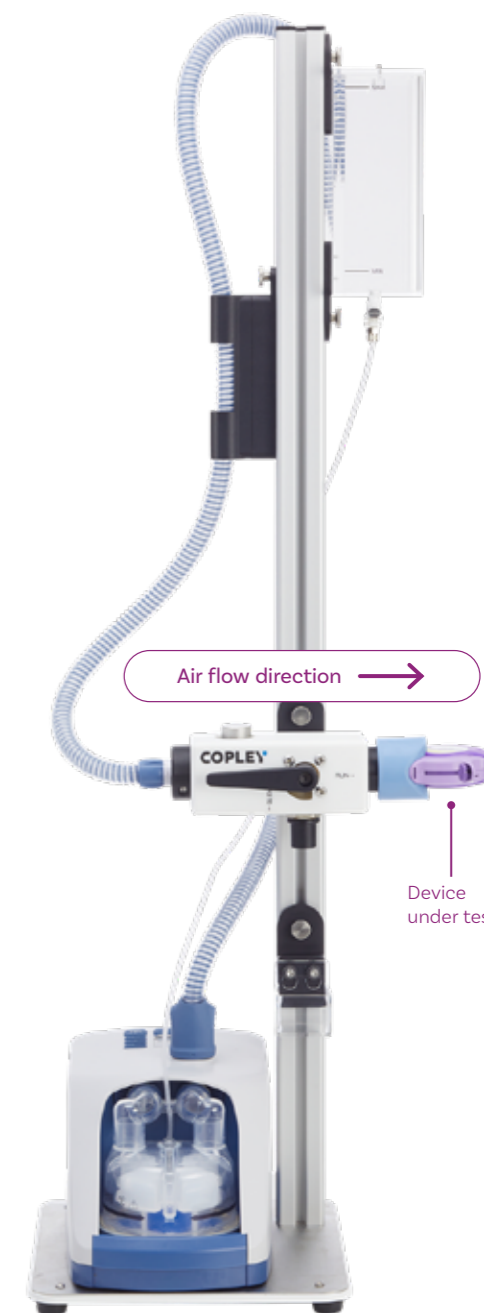

PES Technical Specifications

Temperature set-points	31°C, 34°C, 37°C
Relative humidity	Always saturated
Flow rate range	10 – 60 L/min
Water reservoir capacity	850 mL
PES Performance	
Tested at set-points:	Temperature: 37°C ± 1.5°C
• 34°C, 60 L/min	
Under ambient conditions:	Relative humidity: 85% RH ± 5% RH
• 22°C, 45% RH	
Dimension (w x d x h)	225 x 300 x 1030 mm

Qualification & Maintenance

- Comprehensive IQ/OQ documentation package available
- Extended warranty available

Patient Exhalation Simulator PES

Cat. No.	Description
9120	Patient Exhalation Simulator - Model PES
9126	Qualification Tools for Patient Exhalation Simulator
9130	IQ/OQ Documentation for Patient Exhalation Simulator PES
1076	PES Extended Warranty - 1 year
1077	PES Extended Warranty - 2 years



*Melani et al., 2011. Respiratory Medicine; 105:930-938. Li et al., 2014. Journal of Aerosol Medicine and Pulmonary Drug Delivery; 27:219-227.

Drop Test Apparatus DTA

Inhalers and nasal drug delivery devices are frequently dropped during handling, transport, or patient use. Even a single impact can compromise structural integrity, dose delivery, or device functionality. Without a controlled and repeatable method to simulate these events, it is difficult to generate reliable data or compare results across development stages and test sites.

Inconsistent drop testing introduces variability that can obscure true device performance. Uncontrolled release mechanisms, unclear starting positions, and poorly contained impact zones increase safety risks and reduce confidence in results. This can delay development timelines and complicate regulatory justification.

The Drop Test Apparatus (DTA) provides a controlled free fall release system that enables precise, repeatable drop testing of inhalation and nasal devices. By standardising height, orientation, and impact conditions within a contained test environment, it supports robust device evaluation under real world misuse scenarios and aligns with ISO 20072 free fall testing guidance for drug delivery devices.

-  Flexible starting device positions
-  Precision height adjustment
-  Controlled release system
-  Durable impact surface
-  Transparent impact containment guard
-  Compact laboratory footprint



Key Features:



Adjustable gripper secures a wide range of inhaler and nasal device types in multiple orientations



Robust measurement system to ensure precise test height adjustments, ensuring repeatability across tests



Transparent shield surrounds the base of the DTA to retain the device and any parts after impact, while providing an unobstructed view

DTA Technical Specifications

Device Drop Height	Up to 1 meter (with mm graduations)
Device Gripper Width	Adjustable to maximum 95 mm
Materials of Construction - Test Surface	12 mm thick wooden base with 3 mm thick 316 Stainless Steel top plate
Dimensions (w x d x h)	225 x 300 x 1030 mm Shield height: 300mm

DTA Drop Test Apparatus

Cat. No.	Description
9121	Drop Test Apparatus

NGI Tilting Platform

Standard cascade impactor testing with the Next Generation Impactor (NGI), is typically performed in a fixed orientation. Without the ability to control and assess angle variation, laboratories may miss clinically relevant differences in product performance.

In real-world use, OINDPs are rarely actuated in a perfectly vertical or horizontal position. Patients may tilt the device slightly forwards, backwards or sideways during use. Even small variations in angle can influence overall formulation performance.

The NGI Tilting Platform provides a secure, adjustable solution for inclining the NGI during APSD measurements, enabling the study of actuation angle without compromising test set-up. It also supports the vertical orientation of nasal devices when used with Glass Expansion Chambers, and is suitable for OINDP characterisation studies.

-  Precise angle control for accurate and measurable inclination
-  Enhanced product insight through angle-dependent evaluation
-  Compatible with a wide range of inlets, including the Alberta Idealised Throat, and Alberta Idealised Nasal Inlet.
-  Excellent repeatability for consistent cross-study comparison
-  Flexible configuration for inhalation and nasal testing applications
-  Supports testing at different angles to better reflect real-world drug delivery conditions



NGI Tilting Platform Technical Specifications

Material of Construction:	Aluminium 5083 (Black Anodised)
Angle Range	5-45°
Dimensions (w x d x h)	375 x 425 x 1127 mm
Weight	7 kg

NGI Tilting Platform

Cat. No.	Description
5035	NGI Tilting Platform
5036	Calibrated Digital Protractor for Measuring Tilt Angle
5037	Recalibration of Digital Protractor

Automation

Automation plays a critical role in modern OINDP testing, strengthening control at key workflow stages from actuation and sampling through to preparation and drug recovery.

By reducing manual variability and embedding repeatable processes, Copley's automation solutions support consistent execution across R&D and QC environments. When integrated with Inhalytix®+ for structured data analysis and reporting, automated workflows contribute to a coherent, traceable delivered dose uniformity (DDU) testing and aerodynamic particle size distribution (APSD) measurement lifecycle.

We offer a comprehensive portfolio of modular automation systems supporting both sampling and recovery for DDU testing and APSD measurement.



Strengthen execution consistency



Reduce operator variability



Support traceable workflows



Scale testing capacity



Automated Shake, Fire & Flow Control for MDIs, Nasal Sprays and Nasal Aerosols

Vertus® III Series

Vertus III and Vertus III+ are fully automated benchtop shake and fire systems for precise, controlled and reproducible MDI, nasal spray and nasal aerosol testing.



See page 292.



Automated 10-Way Shake and Fire to Waste for MDIs

DecaVertus® III

A high-throughput 10-way shake and fire to waste system for highly reproducible and controlled MDI testing.



See page 298.



Sample Recovery System™ SRS 100i

Provides controlled recovery from DUSA collection tubes, impactors and other test components to support consistent sample preparation prior to analysis.



See page 302.

Automated Cascade Impactor Preparation

Impactor Coater™ IC 200i

Standardises impaction surface coating for both NGI Collection Cups and ACI Collection Plates.

Recommended for:   

See page 308.



Automated Drug Recovery for APSD Measurement

Gentle Rocker™ GR 200i

Promotes easy and fully repeatable dissolution of active drug present on NGI Collection Cup and ACI Collection Plate surfaces prior to analysis.

Recommended for:   

See page 310.



Automated Drug Recovery for DDU Testing

DUSA Shaker™ DTS 100i

For full, fast and repeatable drug recovery from both MDI and DPI DUSA collection tubes.

See page 306.



Sample Preparation Unit SPU 200i

Simplifies and standardises drug recovery from the Induction Ports and Preseparators.

Recommended for:    

See page 314.



Impactor Cleaning System

Standardises cleaning and drying procedures to help maintain the NGI and ACI in optimum condition.

EC* Recommended for:  

See page 320.



Impactor Genie™ IG 200i An innovative 2-in-1 solution

Combining the coating capabilities of the IC 200i with the drug recovery features of the GR 200i.

Recommended for:   

See page 312.





Automation

Automated Shake, Fire and Flow Control for MDIs, Nasal Sprays and Aerosols

Due to the nature of metered spray pump technology and propellant-based aerosols, the testing of MDIs, nasal sprays and nasal aerosols is inherently susceptible to variability from a number of different sources.

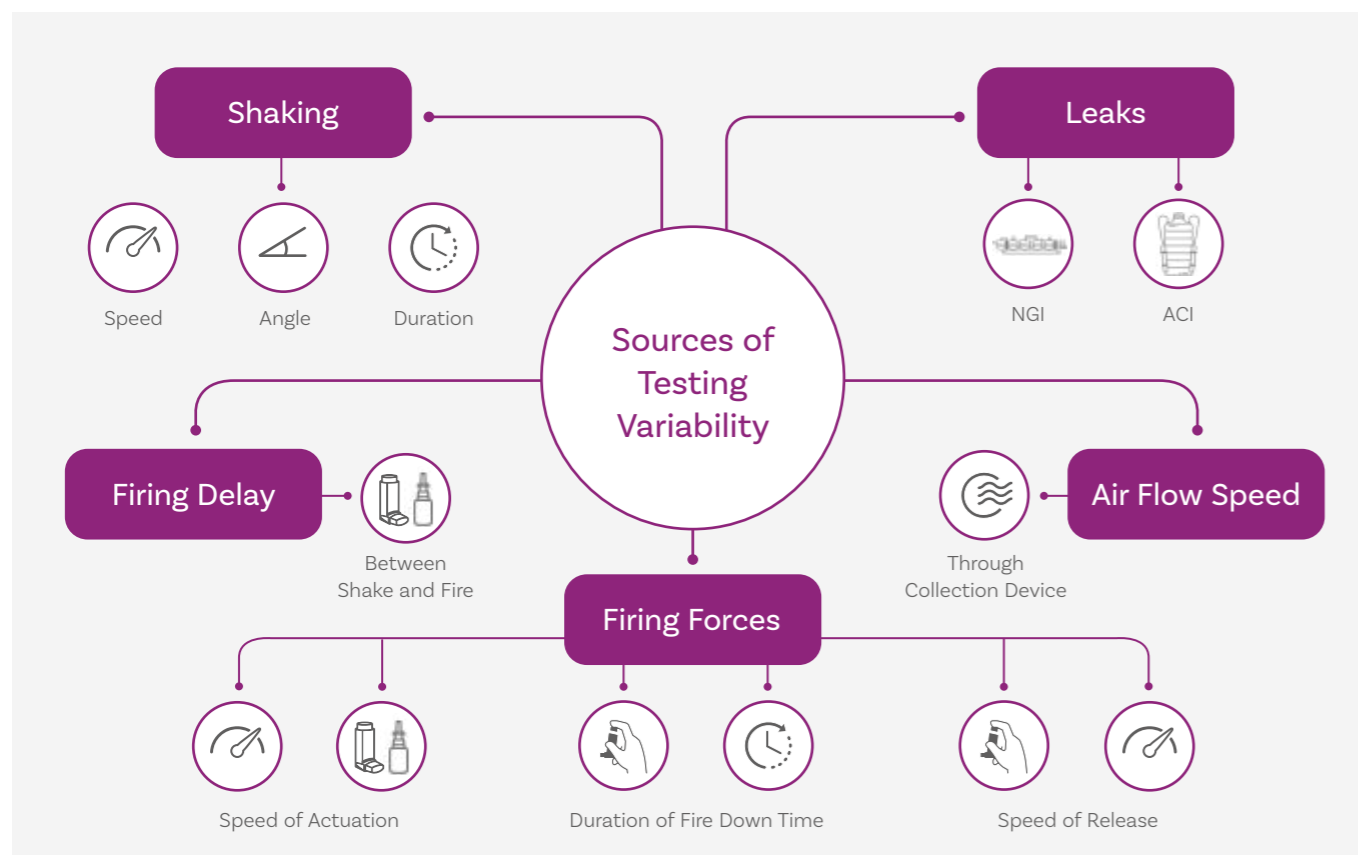

Identifying issues within the test method and limiting variability between analysts can be challenging, but inadequate control may lead to erroneous data and consequently substantial costs to the company.

Automated shake and fire systems enhance the sensitivity of OINDP testing and, more broadly, boost data integrity by eliminating firing errors, controlling air flow speed and automating leak testing. Such systems

enable precise, controlled, reproducible testing while at the same time boosting productivity. Vertus® III and DecaVertus® III range offers extensive parameter control and monitoring, allowing:

- Precise and easy method validation
- Streamlined routine testing
- Cause of variation identification
- Enhanced data integrity and accuracy

Choose your Automated Shake & Fire System



	Vertus III	Vertus III+	DecaVertus III
Max. Number of Devices Supported per Run	1	1	10
Fire to Sample	✓	✓	X
Fire to Waste	✓	✓	✓
Sample Weighing	X	✓	X
Devices supported			
MDIs	✓	✓	✓
Nasal Sprays	✓	✓	X
Nasal Aerosols	✓	✓	✓ (canister only)

Vertus® III Range

Offering precisely controlled and repeatable delivery for Delivered Dose Uniformity (DDU) testing and Aerodynamic Particle Size Distribution (APSD) measurement, the Vertus III and Vertus III+ automate all aspects of MDI, nasal spray and nasal aerosol dose testing.

Compatible with over 40 different collection device combinations including DUSA, Next Generation Impactor (NGI), Alberta Idealised Throat and Nasal Inlets, and Spray Force Tester, the Vertus III range offers total control over the test technique, but the flexibility to apply any industry-standard shake and fire test method.

The Vertus III range offers complete control over all test parameters, including:

Shaking profile

- Speed
- Angle
- Duration

Time between shake and fire



Firing profile

- Force
- Rise time
- Hold time
- Release time

Air flow through the system



As the Vertus III range is fully compatible with DecaVertus® III, methods can be easily transferred between systems, with DecaVertus III used to alleviate the burden of through-life testing.



Ph. Eur., EMA, USP, FDA, ChP and NMPA compliant



21 CFR Part 11 compliant



Precise control over all test parameters



Compatible with all standard collection devices



Suitable for a wide range of MDIs, nasal sprays and nasal aerosols



Integrated air flow



Ideal for both DDU and APSD



Suitable for both R&D and QC applications



In situ impactor leak testing capability



Extensive reporting options



Stores and recalls methods



Broad shake and fire parameters accommodate a wide scope of methods

Key Features:

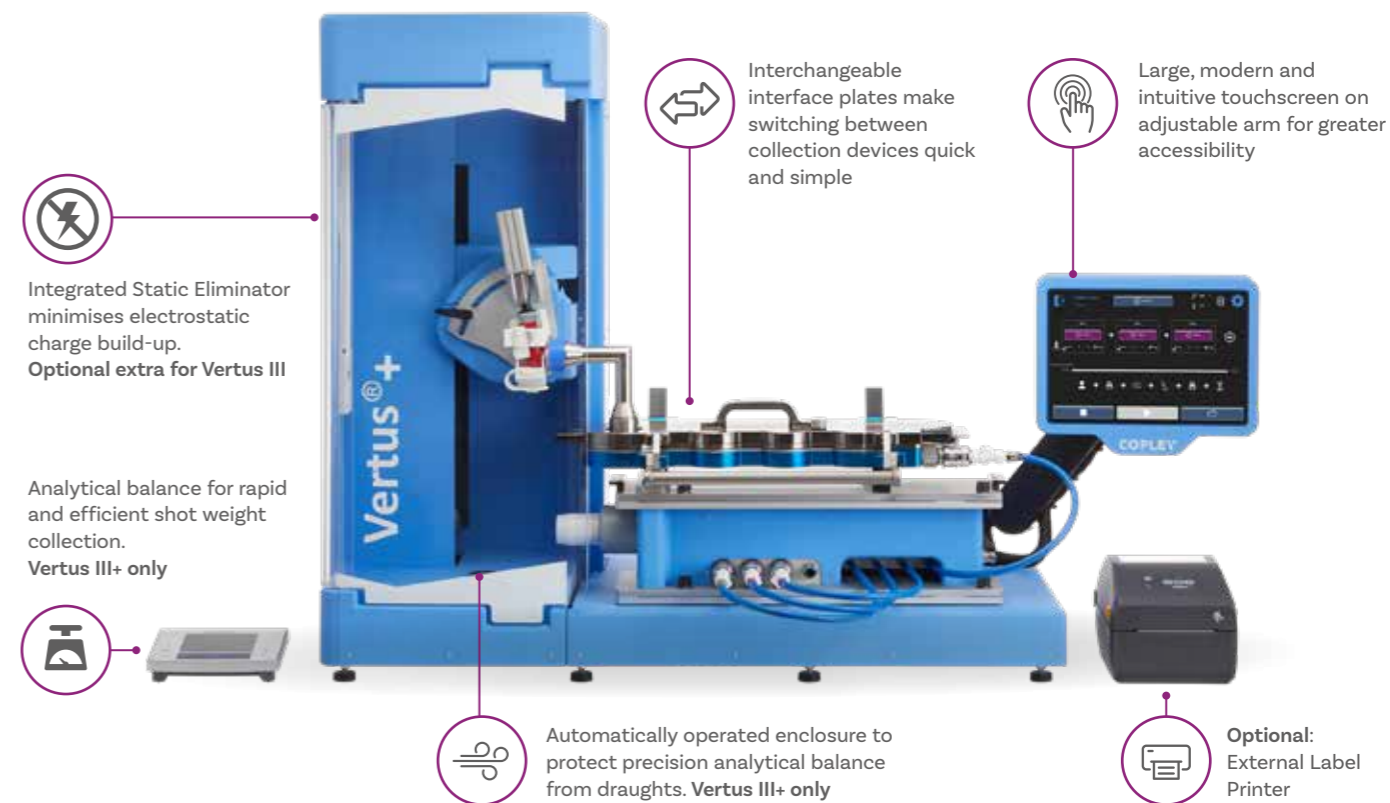

Shot Weight Measurement

The Vertus III+ has the additional capability of measuring shot weight (the weight of the dose released during a single actuation) via an integrated analytical balance. Useful for assessing the consistency of drug release from the device, shot weight is an efficient way to detect misfiring and more broadly, for analytical troubleshooting.

Ph. Eur. (monograph 0676) requires the monitoring of Uniformity of Delivered Mass by collecting shot weights of nasal sprays through life. Automation significantly streamlines the testing process when shot weight information is required.

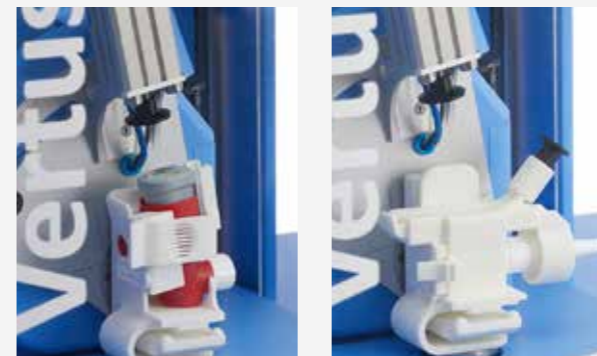

Exhaust Port

The exhaust port supports the efficient extraction of flammable propellants or high potency drugs where additional safety measures are required.



Interface Plates

The Vertus III range is compatible with collection devices for all compendial testing, plus other standard tests for MDIs, nasal sprays and nasal aerosols.

Interface Plates for MDIs



Vertus III shown here with DUSA Stack and Priming & Waste Module

Priming & Waste Module

The new Priming & Waste Module integrates firing-to-waste into automated test methods, enabling compendial entire contents testing with minimal manual input.

Each interface plate can be placed directly on top of the Priming & Waste Module. Vertus III and Vertus III+ can switch automatically between priming and test levels, firing-to-waste or to dose collection as required, without operator intervention. This enables highly efficient testing procedures, most notably to meet through-life test requirements for DDU and APSD. Additionally, the Priming & Waste Module can be used as a standalone interface for waste shot collection.

Interface Plates for Nasal Sprays & Nasal Aerosols



Vertus III shown here with DUSA Interface Plate

For DDU testing of nasal sprays and nasal aerosols, USP <601> recommends a 'mechanical actuation procedure' to control actuation force, speed, stroke length and for units to be 'thoroughly shaken' prior to firing the dose.

In addition to this, the 2003 FDA guidance on Bioavailability and Bioequivalence recommends automated actuation systems for BE assessments to decrease variability in drug delivery.

Compatible Test Interfaces



Priming & Waste Module only



Priming & Waste Module with Next Generation Impactor NGI

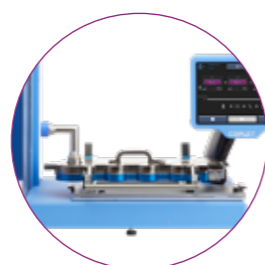

Next Generation Impactor NGI with Induction Port



Andersen Cascade Impactor ACI with Induction Port

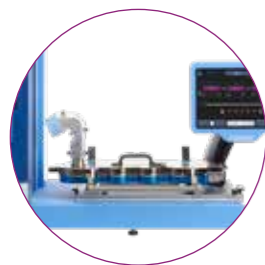

Next Generation Impactor NGI with Adult Alberta Idealised Throat

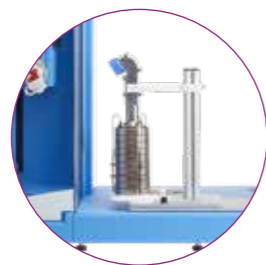

Andersen Cascade Impactor ACI with Child Alberta Idealised Throat

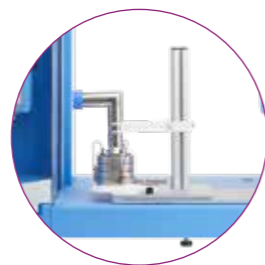

Fast Screening Andersen FSA with Induction Port



Fast Screening Impactor FSI with Adult Alberta Idealised Throat



Glass Twin Impinger GTI



Thin Layer Chromatography (TLC) Plate

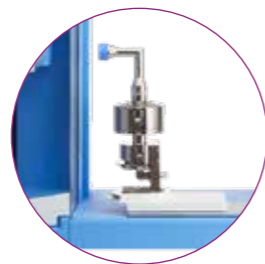

Fast Screening Impactor FSI with Induction Port



Spray Force Tester SFT

Compatible Test Interfaces

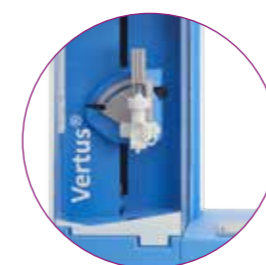

Nasal Spray Dose Collector NSDC



Nasal Spray Waste Collector NSWC



Next Generation Impactor NGI with 2L Glass Expansion Chamber



Andersen Cascade Impactor ACI with Alberta Idealised Nasal Inlet AINI

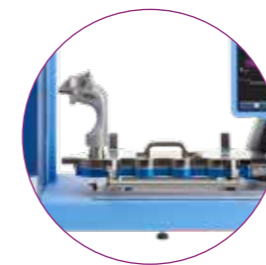

Next Generation Impactor NGI with Alberta Idealised Nasal Inlet AINI

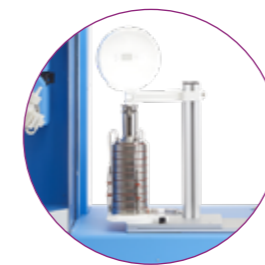

Andersen Cascade Impactor ACI with 2L Glass Expansion Chamber



Fast Screening Andersen FSA with Alberta Idealised Nasal Inlet AINI

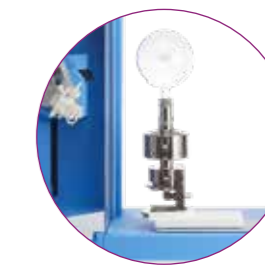

Fast Screening Impactor FSI with 2L Glass Expansion Chamber

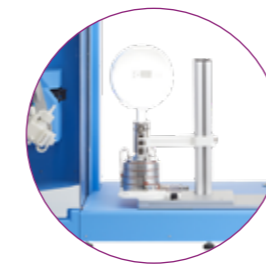

Fast Screening Andersen FSA with 2L Glass Expansion Chamber



Fast Screening Impactor FSI with Alberta Idealised Nasal Inlet AINI



Kiel Nasal Inlet KNI with Next Generation Impactor NGI



Thin Layer Chromatography (TLC) Plate

Technical Specifications: Vertus III & Vertus III+

Shaking parameter control includes:

Shake starting angle	✓	Shake speed	✓
Shake angle	✓	Shake duration	✓

Firing parameter control includes:

Fire force	✓	Force release time	✓
Fire rise time	✓	Firing angle	✓

Air flow parameter control includes:

Air flow rate	✓	Air flow measurement	✓
---------------	---	----------------------	---

Shot weight measurement (Vertus III+ only)

Weight range:	0.01 mg to 200 g
	Resolution: 0.01 mg

Device compatibility

MDIs:	✓	Nasal aerosols:	✓
Nasal sprays:	✓		

User interface:

10.1" colour touchscreen

Dimensions (w x d x h):

1020 x 510 x 920 mm

Connectivity:

- Ethernet x 4
- USB x 3
- Run Out digital output
- Run In digital input
- RS-232
- Balance for shot weight collection
- Temperature & Relative Humidity probe
- Label Printer



Vertus III and Vertus III+ are both compatible with Inhalytix+, enabling instrument metadata and operational parameters to be linked directly to APSD measurement records for improved traceability.

See page 218 for more information.

Qualification & Maintenance

- Comprehensive IQ/OQ documentation
- Qualification kit available
- Extended warranty available
- Remote support and field servicing available



A range of service contract options are available for the Vertus range. Please contact us for further details.

Vertus III & Vertus III+: Reporting

Extensive data output options are available as standard:

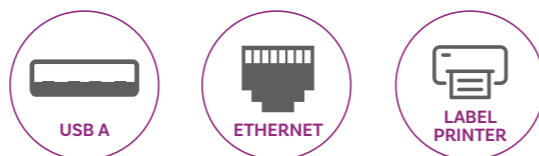

Reported Parameters:

- Run report
- Audit report
- Method report

Vertus III / Vertus III+ Shake and Fire System

Cat. No.	Description
9770	Vertus III Shake and Fire System
9790	Vertus III+ Shake and Fire System
9772	Anti-Static option for Vertus III
1078	Vertus III Extended Warranty - 1 year
1079	Vertus III Extended Warranty - 2 years
1080	Vertus III+ Extended Warranty - 1 year
1081	Vertus III+ Extended Warranty - 2 years

Interface plates

9777	DUSA (x4) Interface Plate for MDIs for Vertus III
9749	DUSA (x1) Interface Plate for Nasal Products for Vertus II and III
9775	NGI Interface Plate for Vertus III
9715	GTI Interface Plate for Vertus II and III
9744	FSI Interface Plate for Vertus II and III
9776	ACI/FSA Interface Plate for Vertus III
9784	Spray Force Tester Interface Plate for Vertus III
9778	Gripper for USP & Nasal Induction Port for Vertus III
9779	Gripper for FP Induction Port for Vertus III
9756	OPC-S Throat for use with Vertus III
9757	OPC-M Throat for use with Vertus III
9758	OPC-L Throat for use with Vertus III
9769	IDA Interface Plate for Vertus III
9781	Gripper for Alberta Idealised Nasal Inlet (AINI) for Vertus III
9782	Gripper for Adult Alberta Idealised Throat (AIT) for Vertus III
9783	Gripper for Child Alberta Idealised Throat (AIT) for Vertus III
9785	TLC Plate Interface Plate for MDIs, Small for Vertus III
9786	TLC Plate Interface Plate for MDIs, Large for Vertus III
9787	TLC Plate Interface Plate for Nasal Sprays, Small for Vertus III
9788	TLC Plate Interface Plate for Nasal Sprays, Large for Vertus III

Accessories for MDI

9705	MDI Holder (per inhaler design)
9901	Mouthpiece Adapter Mould (per inhaler/inlet design)
9902	Mouthpiece Adapter for ACI/NGI Induction Port and DUSA
9903	Mouthpiece Adapter for Other Inlets (each)

Accessories for Nasal

9735	Nasal Spray Dose Collector (NSDC) for Vertus II and III
9736	Nasal Spray Waste Collector (NSWC) for Vertus II and III
9738	Nasal Spray Holder for use with NSDC and NSWC
9746	Nasal Spray Holder for use with Expansion Chamber
9747	Nasal Spray Holder for use with AINI & DUSA
9748	Nasal Spray Holder for use with GTI
8544	Nasal Device Nosepiece Adapter for AINI
8545	Tooling Charge (per nasal device)
9781	Gripper for Alberta Idealised Nasal Inlet (AINI) for Vertus III
9910	Nosepiece Adapter for ACI/NGI Induction Port and DUSA
9901A	Nosepiece Adapter Mould (per nasal spray design)

General Accessories

Cat. No.	Description
9773	Temperature and Humidity Sensor for Vertus III
9765	Label Printer
9798	Vertus III, Vertus III+, DecaVertus III Qualification Kit
9799	Re-calibration of Vertus III/DecaVertus III Qualification Tools
9774	IQ/OQ Documentation for Vertus III/Vertus III+
9714	Air compressor
8791	Foot Switch - compatible with TPK/BAC/BRS/Vertus/DecaVertus

Maintenance and Support

1006	Remote Access Support for Vertus/DecaVertus (1yr/10hrs)
9721	Remote Diagnostic Gateway
9724	Direct Connection Setup - Remote Support

Spares

9712	Spare Filter Cartridge for Waste Shot Collector
9716	Direct Thermal Printer Labels (12 Rolls of 475 each) - spares
9719	Thermal Transfer Printer Labels (12 Rolls of 475 each) - optional
9725	Thermal Transfer Printer Ribbon (6 Cartridges) - optional
9792	TLC Pre-Coated Plates Size 5 x 10cm (50 Plates)
9793	TLC Pre-Coated Plates Size 5 x 20cm (100 Plates)
9794	TLC Pre-Coated Plates Size 10 x 20cm (50 Plates)
9795	TLC Pre-Coated Plates Size 20 x 20cm (25 Plates)
9796	Inline Filter for Vacuum Inlet



DecaVertus® III

Automating firing-to-waste for through life testing of up to ten MDIs per test run, the DecaVertus is a high-throughput system for reproducible, controlled testing.

Highly advantageous from the perspective of enhancing test repeatability, conserving analyst time and eliminating the risk of repetitive strain injury (RSI), the DecaVertus ensures firing-to-waste occurs under closely controlled conditions, eliminating potential sources of variability from testing.

DecaVertus III offers complete control over all test parameters, including:

Shaking profile

- Speed
- Angle
- Duration

Time between shake and fire



Firing profile

- Force
- Rise time
- Hold time
- Release time

Air flow through the system



As DecaVertus III is fully compatible with the Vertus® III range, methods can be easily transferred between systems, enabling the same parameters to be used for dose collection on Vertus III and through life firing-to-waste on DecaVertus.



- Ph. Eur., EMA, USP, FDA, ChP and NMPA compliant
- Precise control over all test parameters
- Improves reproducibility and frees up analyst time
- Stores and recalls methods
- Broad shake and fire parameters accommodate a wide scope of methods

- 21 CFR Part 11 compliant
- Suitable for a wide range of MDI devices
- Independent air flow control per channel
- Extensive reporting options

Key Features:

- Capacity for up to 10 inhalers at a time **x10**
- Suitable for device and can only testing
- Internal components are easy to clean
- Large, modern, and intuitive touchscreen for ease of use

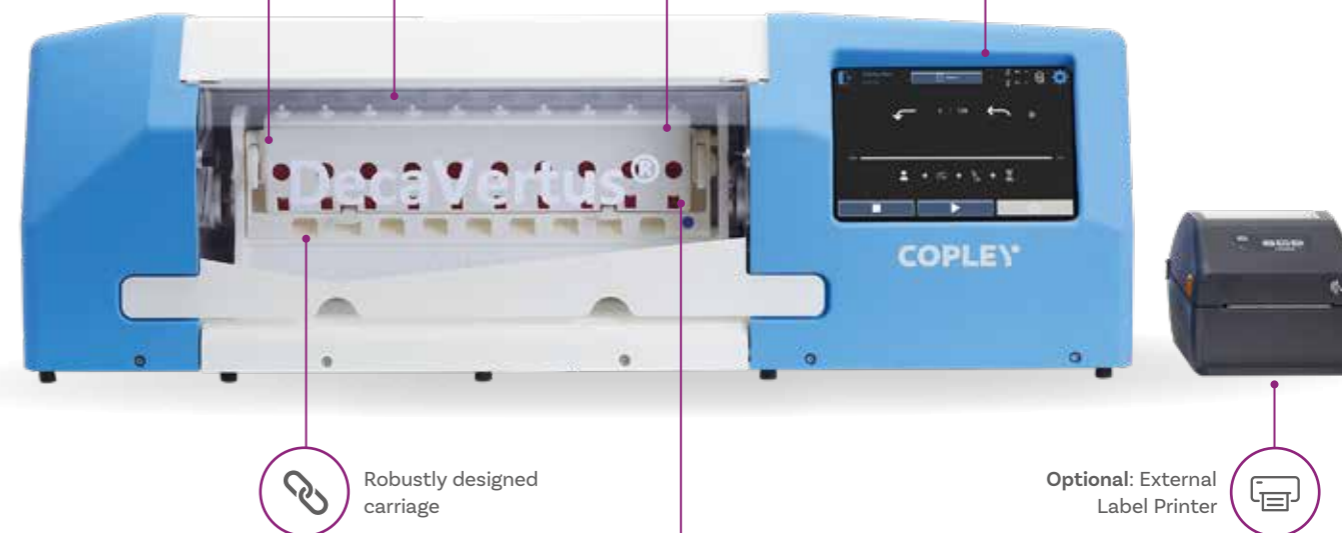

Optional: External Label Printer

Exhaust Port

The exhaust port supports the efficient extraction of flammable propellants and/or high potency drugs where additional safety measures are required.

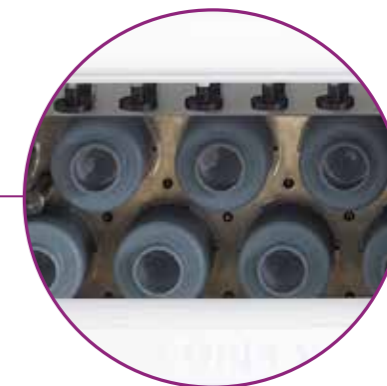

Independent air flow control for each channel: each inhaler has its own dedicated air flow channel to minimise clogging and enable high-volume products to be tested in a single run, reducing the need to stop and clean the filters.



Technical Specifications: DecaVertus III

Shaking parameter control includes:

Shake starting angle	✓	Shake speed	✓
Shake angle	✓	Shake duration	✓

Firing parameter control includes:

Fire force	✓	Force release time	✓
Fire rise time	✓	Firing angle	✓

Air flow parameter control includes:

Air flow before firing	✓	Air flow after firing	✓
------------------------	---	-----------------------	---

Device compatibility

MDIs:	✓	Can-only:	✓
-------	---	-----------	---

User interface:

10.1" colour touchscreen

Dimensions (w x d x h):

1130 x 630 x 370 mm

Connectivity:

- Ethernet x 2
- USB x 3
- Run In digital input
- RS-232
- Run Out digital output
- Label Printer



Compatible

Vertus III and Vertus III+ are both compatible with Inhalytix+, enabling instrument metadata and operational parameters to be linked directly to APSD measurement records for improved traceability.

See page 218 for more information.

Qualification & Maintenance

- Comprehensive IQ/OQ documentation
- Qualification kit available
- Extended warranty available
- Remote support and field servicing available



A range of service contract options are available for DecaVertus III. Please contact us for further details.

DecaVertus III: Reporting

Extensive data output options are available as standard:

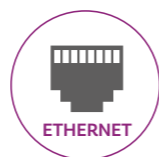

Reported Parameters:

- Run report
- Audit report
- Method report

DecaVertus III Waste Shot Collection System for 10 MDIs

Cat. No. Description

- 9870** DecaVertus III Shake and Fire to Waste System
- 1082** DecaVertus III Extended Warranty - 1 year
- 1083** DecaVertus III Extended Warranty - 2 years

Accessories (MDIs only)

- 9805** Carriage for MDI (per inhaler design)
- 9808** Can Only Carriage for DecaVertus (per can design)
- 9798** Vertus III, Vertus III+, DecaVertus III Qualification Kit
- 9799** Re-calibration of Vertus III/DecaVertus III Qualification Tools
- 9871** IQ/OQ Documentation for DecaVertus III
- 9765** Label Printer
- 8791** Foot Switch - compatible with TPK/BAC/BRS/Vertus/DecaVertus

Spare parts

- 9716** Direct Thermal Printer Labels (12 Rolls of 475 each)
- 9719** Thermal Transfer Printer Labels (12 Rolls of 475 each)
- 9725** Thermal Transfer Printer Ribbon (6 Cartridges)
- 9820** Pack of 10 Spare Waste Filter Cartridges
- 9821** Pack of 100 O-rings for Actuator Pins
- 9850** Replacement Set of 10 Actuator Pins for DecaVertus Carriage

Maintenance and Support

- 1006** Remote Access Support for Vertus/DecaVertus (1yr/10hrs)
- 9721** Remote Diagnostic Gateway
- 9724** Direct Connection Setup - Remote Support



Sample Recovery System™ SRS 100i

Patent pending

Manual drug recovery from DUSA collection tubes, impactors and other test components is inherently variable. Small differences in solvent volume, dissolution technique or sample handling can affect recovered mass and, ultimately, reported DDU and APSD results.

The Sample Recovery System SRS 100i is an automated solution for drug recovery, designed to control and standardise this critical stage of OINDP testing. By automating solvent dispensing, dissolution and sample collection, it delivers a consistent, repeatable recovery process.

Configurable for NGI, ACI, DUSA and other test components, the system produces controlled, HPLC-ready samples. It also reduces hands-on effort while enabling existing methods to be applied within a controlled workflow.



Reproducible drug recovery across analysts and sites



HPLC-ready samples for immediate analysis



Configurable to suit most laboratory workflows



Controlled solvent dispensing and dissolution



Eliminates risk of cross-contamination



Supports consistent and standardised workflows



Reduced manual handling and hands-on recovery time



Aligns with established recovery methods



Designed for use in regulated environments (21 CFR Part 11 and GMP)

Drug Recovery for DDU and APSD in Four Steps



1. Load

Load the components into the dedicated holders:
 - DUSA collection tubes
 - Induction port, preseparator, external filter holder, collection cups or plate trays and alternative inlet components (e.g. Alberta Idealised Throat)

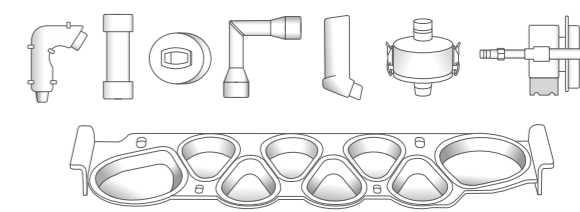

2. Dispense

The solvent handling system delivers precise, user-defined volumes of solvent to each component and collection surface.

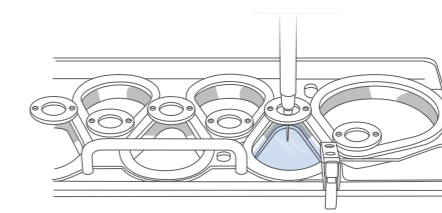

3. Dissolve

Dissolution is controlled according to component type to ensure complete and consistent drug recovery.

Collection cups/plates undergo controlled rocking to ensure complete and uniform dissolution of the deposited drug.

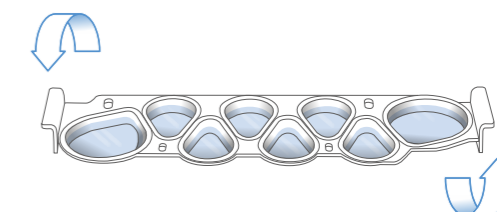

Top Tip

Pair the SRS 100i with the DUSA Tube Shaker DTS 100i for standardised rinsing of DUSA collection tubes, or with the Sample Preparation Unit SPU 200i for simplified drug recovery from induction ports and preseparators. Components are rinsed using the appropriate system before returning to the SRS 100i for sample collection (see pages 306 and 314 respectively for more information).

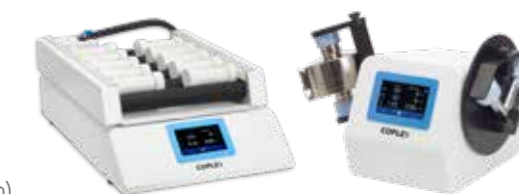

For smaller components, the SRS dispenses precise solvent volumes into labelled beakers, supporting consistent recovery using existing methods.



4. Collect

Dissolved samples from each component and collection surface are aspirated directly into individual HPLC vials, ready for immediate analysis

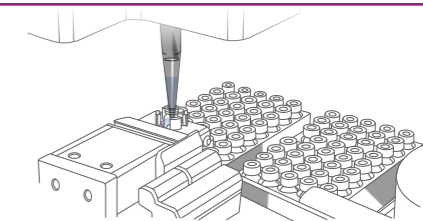

Engineered for Controlled Recovery

Dedicated solvent dispensing and sample aspiration heads remove the need for wash cycles, eliminating the risk of cross-contamination between samples.



Solvent dispensing head



Sample aspiration head



Precision Sample Handling

Recovered samples are aspirated and transferred directly into individual HPLC vials, ready for quantitative analysis with minimal manual intervention.

Qualification & Maintenance

- Comprehensive IQ/OQ documentation
- Qualification kit available
- Extended warranty available
- Remote support and field servicing available

SRS 100i Technical Specifications

Dispensing accuracy	± 1%
Agitation speed	10 - 60 RPM (± 1 RPM)
Run Time	Up to 24 hours or Up to 60,000 revolutions
Connectivity:	USB A, USB B, RS-232 Run in digital input
Dimensions (w x d x h)	590 x 320 x 235 mm

Supports drug recovery from a wide range of OINDP testing components including inlets such as the Alberta Idealised Throat, as well as inhalers, mouthpiece adapters and external filter holders.

Flexible Configurations for OINDP Testing Workflows

Configurable to support a range of test set-ups



NGI configuration



ACI configuration



MDI DUSA configuration



DPI DUSA configuration



The SRS 100i is compatible with Inhalytix+, enabling instrument metadata and operational parameters to be linked directly to APSD measurement records for improved traceability.

See page 218 for more information.

Sample Recovery System™ SRS 100i

Cat. No.	Description
7810	Sample Recovery System SRS 100i for NGI
7811	Sample Recovery System SRS 100i for ACI
7812	Sample Recovery System SRS 100i for MDI DUSAs
7813	Sample Recovery System SRS 100i for DPI DUSAs

Interface Plates

Cat. No.	Description
7820	NGI Interface Plate for SRS 100i with NGI Induction Port Fixture
7821	NGI Interface Plate for SRS 100i with AIT-A Fixture
7822	NGI Interface Plate for SRS 100i with AIT-C Fixture
7823	ACI Interface Plate for SRS 100i with USP Ind. Port Fixture
7824	ACI Interface Plate for SRS 100i with AIT-A Fixture
7825	ACI Interface Plate for SRS 100i with AIT-C Fixture
7826	MDI DUSA Interface Plate for SRS 100i
7827	DPI DUSA Interface Plate for SRS 100i

Accessories

Cat. No.	Description
7831	Emergency Stop Button for SRS 100i
7830	Qualification Kit for SRS 100i
7832	Re-calibration of Qualification Kit for SRS 100i
7833	IQ/OQ Documentation for SRS 100i
9765	Label Printer
9719	Thermal Ink Transfer Labels (12 Rolls)
9725	Ribbon for Thermal Ink Transfer (Pack of 6)
1665	Ohaus Balance



Key Features:



DUSA Shaker™ DTS 100i

Manual drug recovery from the Dose Uniformity Sampling Apparatus (DUSA) for dose uniformity testing can be time-consuming, prone to variability and may lead to repetitive strain injury (RSI).

The DUSA Shaker™ DTS 100i provides full, fast and repeatable drug recovery from all internal MDI and DPI DUSA collection tube surfaces, for quicker, more efficient regulatory and compendial delivered dose uniformity (DDU) testing.

Eliminating a time-consuming and highly variable manual drug recovery process, the DTS 100i releases analysts for higher value work whilst reducing the risk of exposure to RSI.

For those new to automation, the DTS 100i is a perfect low-cost, first step towards reduced test variability, fewer out of specification results, greater productivity and safer working practice. For established laboratories, the DTS 100i is a cost-efficient, modular solution that will slot easily into existing set-ups and workflows.

- Boosts throughput by up to 10 times
- Achieves complete drug recovery via multi-directional mixing
- Improves data integrity
- Accepts both MDI and DPI DUSA collection tubes
- 3 rinsing actions: Shake, Roll, or Shake and Roll
- Enhances productivity

When assessing DDU of DPIs, DUSA collection tubes without a P1 port must be used to enable rotation (Cat No. 8608A, Collection Tube without P1 Port).

DTS 100i: User Interface

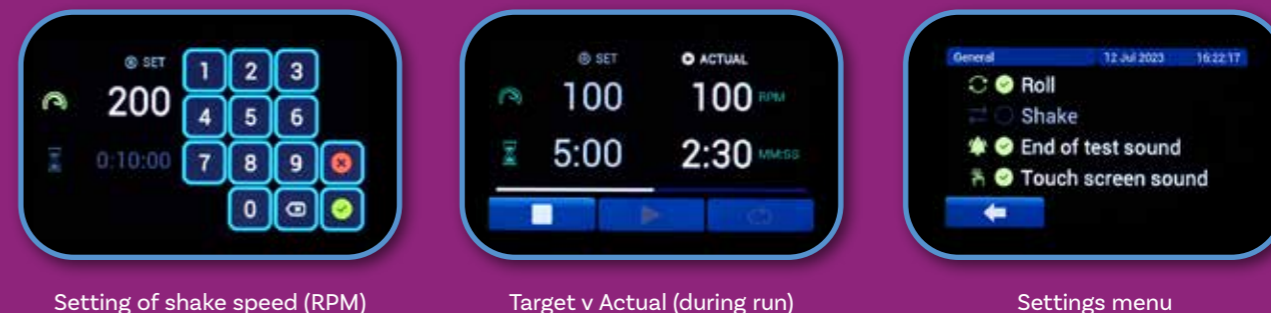

DTS 100i Technical Specifications

DUSA Collection Tube Capacity	DUSA for MDIs x 10 DUSA for DPIs x 10
Shake Speed:	20 - 200 RPM
Roller Rotational Speed:	Fixed at 11.4 RPM
Timer Control:	Up to 100 hours
Connectivity:	USB A, USB B, RS-232
Dimensions (w x d x h)	410 x 626 x 227 mm

Qualification & Maintenance

- Comprehensive IQ/OQ documentation packages and toolkits available
- Qualification Kit available
- Extended Warranty available

DUSA Shaker™ DTS 100i

Cat. No.	Description
8630	DUSA Shaker DTS 100i (without collection tubes)
8621	IQ/OQ Documentation for DUSA Shaker
8623	Qualification Tools for DUSA Shaker
8624	Re-calibration of DUSA Shaker Qualification Tools
1032	DUSA Shaker Extended Warranty - 1 year
1033	DUSA Shaker Extended Warranty - 2 years



IC 200i with NGI Collection Cup Tray



IC 200i with ACI Collection Plate Tray & Cups
ACI Collection Plate Tray & Cups purchased separately.
(Cat. No. 5933)

Impactor Coater™ IC 200i

To prevent particle bounce and subsequent re-entrainment within the flowing airstream during aerodynamic particle size distribution (APSD) sampling, regulators recommend the coating of each impactor stage collection surface. However, the manual coating of each collection surface is prone to variability and is labour-intensive.

The **Impactor Coater IC 200i** reproducibly applies surface coatings to both the NGI Collection Cups and the ACI Collection Plates, eliminating the problem of particle bounce and re-entrainment when using cascade impactors to measure the APSD of OINDPs.

Standardising the application of surface coating to each collection surface, the IC 200i removes the inherent variability associated with the coating process, while boosting laboratory productivity and throughput.

- Coats surfaces in as little as 2 minutes
- Frees up analysts for other tasks
- Enables easy method transfer between sites
- Minimises coating solution wastage

IC 200i Technical Specifications

Flow Rate	0 - 100%
Dispense and Reverse Cycle Time	0 - 10 minutes
Connectivity:	USB A and USB B
Dimensions (w x d x h)	590 x 320 x 250 mm [IC 200i] 150 x 220 x 130 mm [Pump]

A note about impaction surface coating

For OINDPs where the particles are hard and dry, (e.g. Dry Powder Inhalers (DPIs)) or where only a few actuations are delivered to the impactor, such as is the case for Metered Dose Inhaler (MDIs), particle bounce and re-entrainment in the flowing airstream can bias the measured size data to finer sizes.

It is therefore important to assess the potential impact of these phenomena on downstream stages at an early point in development so that corrective action can be taken.

Coating the impaction surfaces with a tacky, viscous material such as glycerol or silicone oil is recommended by the regulators to address this problem. If a surface coating is required, the amount, its uniformity and the method in which it is applied and its potential to affect drug recovery should be assessed during method development.

Key Features:

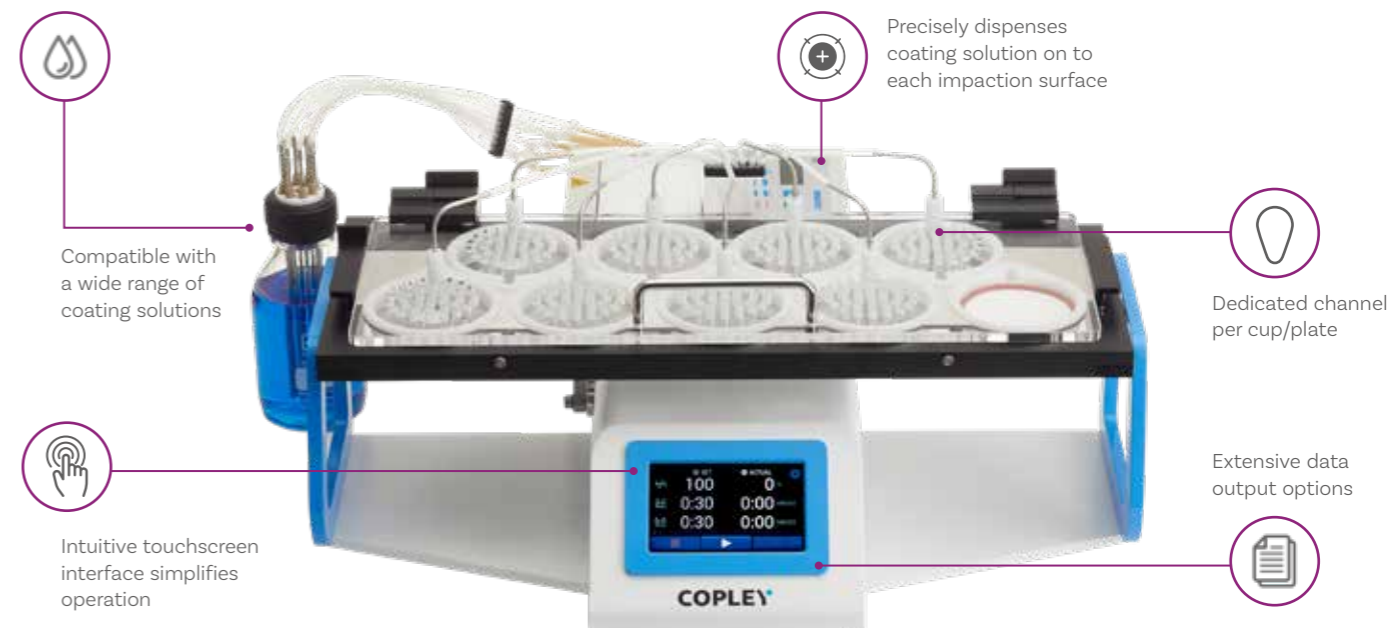

IC 200i: User Interface

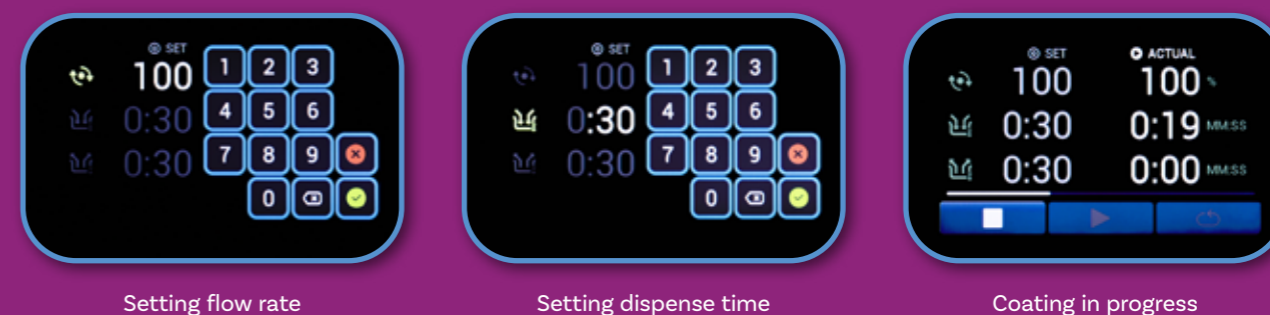

Inhalytix⁺
Compatible

The IC 200i is compatible with Inhalytix+, enabling instrument metadata and operational parameters to be linked directly to APSD measurement records for improved traceability. See page 218 for more information.

Qualification & Maintenance

- Comprehensive IQ/OQ/PQ documentation package and toolkit available
- Extended warranty available

Impactor Coater™ IC 200i

Cat. No.	Description
5940	Impactor Coater Model IC 200i
5942	Cover and Tubing Set for NGI Cup Tray & Cups
5941	Cover and Tubing Set for ACI Collection Plate Tray & Cups
5933	ACI Collection Plate Tray & Cups

Spares

5947	Spare Set of 8 Pump Tubing Cassettes
5901	500 mL Solvent Reservoir complete with 8-way Cap
5902	1000 mL Solvent Reservoir complete with 8-way Cap

Accessories

Cat. No.	Description
5943	IQ/OQ Documentation for Impactor Coater ICi Series
5926	Qualification Tools for GR, IC, IGI Series
5927	Re-calibration of Qualification Tools for GR, IC, IGI Series
1072	IC 200i Extended Warranty - 1 year
1073	IC 200i Extended Warranty - 2 years
8120	Inhaler Testing Workstation - BasePlate and Upright
8140	ITW Cover Stand Attachment
5224	Storage Cabinet for Impactor Collection Trays
8766	Printer



GR 200i with NGI Collection Cup Tray



GR 200i with ACI Collection Plate Tray Plate & Cups
ACI Collection Plate Tray & Cups purchased separately.
(Cat. No. 5933)

Gentle Rocker™ GR 200i

Drug recovery from each collection surface is a critical but time-consuming element of aerodynamic particle size distribution (APSD) sampling with a cascade impactor. It involves dispensing a defined aliquot of solvent on to each surface, followed by repeated agitation to ensure complete drug dissolution.

The Gentle Rocker GR 200i promotes easy and fully repeatable dissolution of the active drug present in both the NGI Collection Cups and on the ACI Collection Plate surfaces following sampling.

Gently agitating solvent back and forth across the impaction surface to aid assay sample preparation, the GR 200i enables specific, reproducible drug recovery and easy method transfer, delivering reliable results and a lighter analytical workload.

- Quick and easy drug recovery
- Suitable for a broad range of drug recovery methods
- Frees up analysts for other tasks
- Enables easy method transfer between sites

GR 200i Technical Specifications

Agitation speed	10 – 60 RPM (± 1 RPM)
Run Time	Up to 100 hours or Up to 60,000 revolutions
Connectivity:	USB A, USB B, RS-232
Dimensions (w x d x h)	590 x 320 x 235 mm



Optional: **Low Evaporation Cover** with seals to minimise solvent loss where evaporation is a particular problem

Key Features:

- Rocks back and forth along a central longitudinal axis
- Samples protected during process by dust cover
- Intuitive touchscreen interface simplifies operation
- Adjustable agitation speed range: 10-60 RPM
- Extensive data output options
- Innovative tray tilting function eases sample collection post-drug recovery

GR 200i: User Interface

- Setting speed range
- Sample agitation in progress
- Data output options

Inhalytix⁺ Compatible

The GR 200i is compatible with Inhalytix+, enabling instrument metadata and operational parameters to be linked directly to APSD measurement records for improved traceability. See page 218 for more information.

Qualification & Maintenance

- Comprehensive IQ/OQ/PQ documentation package and toolkit available
- Extended warranty available

Gentle Rocker™ GR 200i

Cat. No.	Description
5932	Gentle Rocker Model GR 200i
5933	ACI Collection Plate Tray & Cups

Accessories

Cat. No.	Description
5925	IQ/OQ Documentation for Gentle Rocker GRi Series
5926	Qualification Tools for GR, IC, IGI Series
5927	Re-calibration of Qualification Tools for GR, IC, IGI Series
1070	GR 200i Extended Warranty - 1 year
1071	GR 200i Extended Warranty - 2 years
5934	Low Evaporation Cover for ACI Collection Plate Tray & Cups
5935	Low Evaporation Cover for NGI Cup Tray & Cups
8120	Inhaler Testing Workstation - Baseplate and Upright
8140	ITW Cover Stand Attachment
5224	Storage Cabinet for Impactor Collection Trays
8766	Printer



Impactor Genie™ IG 200i

Combining the impaction surface coating power of the Impactor Coater™ IC 200i with the drug recovery capabilities of the Gentle Rocker™ GR 200i, the Impactor Genie IG 200i is the ultimate 2-in-1 solution for quicker, more efficient, regulatory and compendial aerodynamic particle size distribution (APSD) impactor preparation and drug recovery.

Compatible with both NGI Collection Cups and ACI Collection Plates, the IG 200i transforms both pre- and post-sampling processing for busy analysts.

Offering double the automation power, the IG 200i enhances sampling repeatability and accuracy, while boosting analytical productivity and enabling easy method transfer between sites.

Transform between Impactor Coater and Gentle Rocker in 2 easy steps!

Mode: Impactor Coater IC 200i

Step 1. Switch lid **Step 2. Switch mode**

Mode: Gentle Rocker GR 200i

ACI Collection Plate Tray & Cups

Required to enable compatibility with the collection plates of the Andersen Cascade Impactor (ACI), the **ACI Collection Plate Tray & Cups** accommodates all 8 stages, plus filter.



Impactor Genie™ IG 200i: Accessories

Cover Stand

Included as standard with purchase of the IG 200i, the **Cover Stand** is ideal for storing the Dust Cover, Impactor Coater Cover and/or Low Evaporation Cover when not in use. Additional attachments holders can be purchased separately.



Low Evaporation Cover

Fitted with seals and retaining clips, the **Low Evaporation Cover** minimises solvent loss where risk of evaporation is a particular problem.



Storage Cabinet for Impactor Collection Trays

Providing storage for up to six NGI Collection Cup Trays and/or ACI Collection Plate Trays, the space-saving **Storage Cabinet** helps keep benchtop spaces tidy and organised (trays not included).

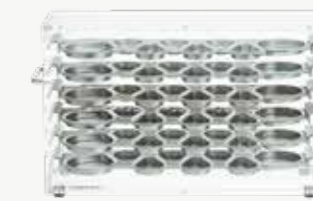

Qualification & Maintenance

- Comprehensive IQ/OQ/PQ documentation package and toolkit available
- Extended warranty available



The IG 200i is compatible with Inhalytix+, enabling instrument metadata and operational parameters to be linked directly to APSD measurement records for improved traceability. See page 218 for more information.

Impactor Genie IG 200i

Cat. No.	Description
5945	Impactor Genie Model IG 200i
5933	ACI Collection Plate Tray & Cups
5941	Cover and Tubing Set for ACI Collection Plate Tray & Cups
5942	Cover and Tubing Set for NGI Cup Tray & Cups

Spares

5947	Spare Set of 8 Pump Tubing Cassettes
8140	ITW Cover Stand Attachment
5901	500 mL Solvent Reservoir complete with 8-way Cap
5902	1000 mL Solvent Reservoir complete with 8-way Cap

Accessories

Cat. No.	Description
5946	IQ/OQ Documentation for Impactor Genie IGI Series
5926	Qualification Tools for GR, IC, IGI Series
5927	Re-calibration of Qualification Tools for GR, IC, IGI Series
1074	IG 200i Extended Warranty - 1 year
1075	IG 200i Extended Warranty - 2 years
5934	Low Evaporation Cover for ACI Collection Plate Tray & Cups
5935	Low Evaporation Cover for NGI Cup Tray & Cups
5224	Storage Cabinet for Impactor Collection Trays
8766	Printer

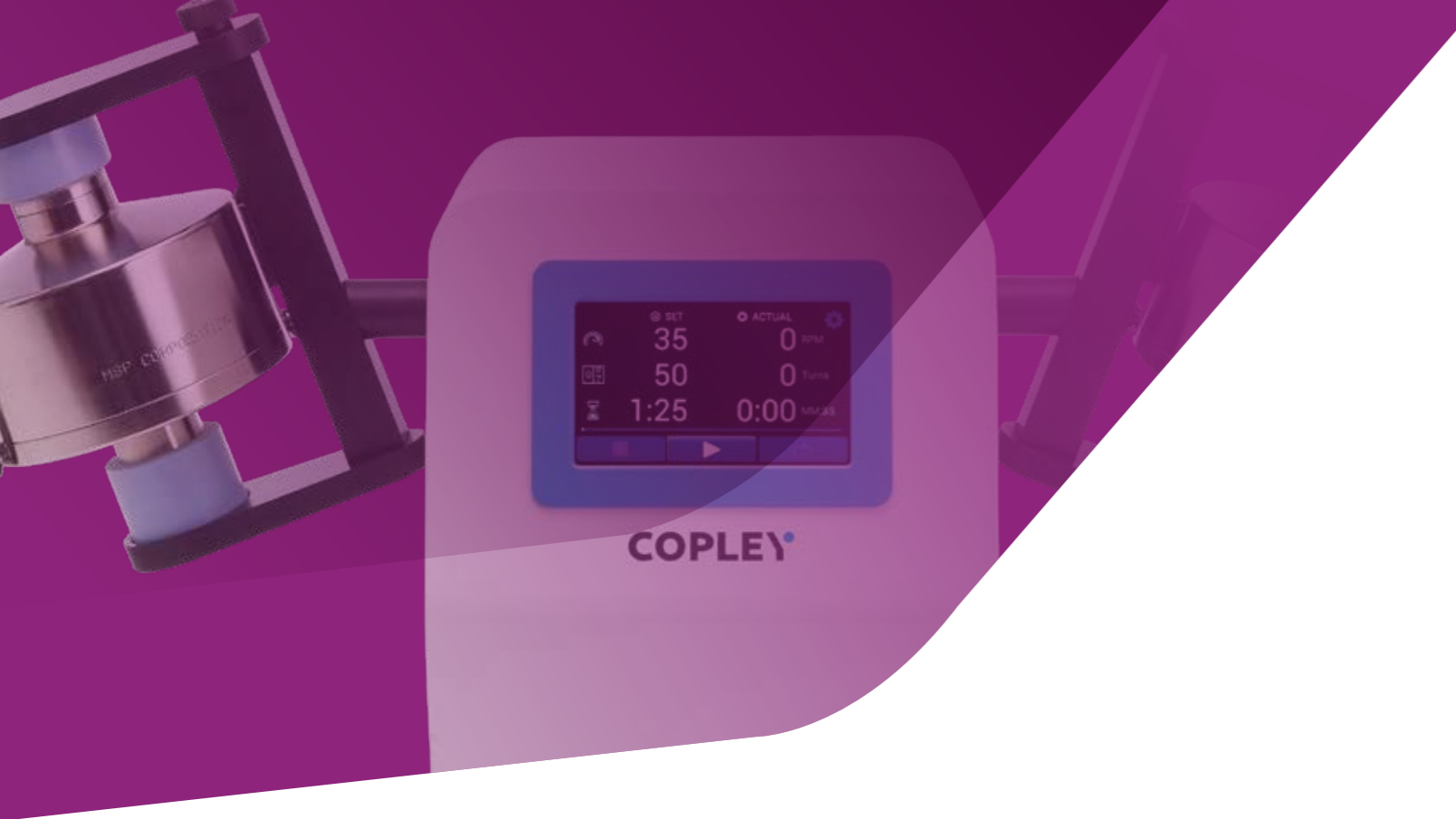

Sample Preparation Unit SPU 200i

Ensuring full, reproducible drug recovery from the NGI, ACI and FP/Salmeterol Induction Ports and the NGI and ACI Preseparators, the Sample Preparation Unit SPU 200i automates repetitive drug recovery procedures, alleviating testing bottlenecks and reducing the unwanted effects of repetitive strain injury (RSI).



Easy to use touchscreen interface



Reproducible sample preparation



Variable speed control for different dissolution applications



Ideal for use with Induction Ports and/or Preseparators

Key Features:





SPU 200i fitted with 2 x NGI Preseparators



SPU 200i fitted with 2 x Advanced Filter holders



SPU 200i fitted with 2 x ACI Induction Ports



SPU 200i fitted with 2 x ACI Preseparators



Fixture with ACI/Albuterol Induction Port



Fixture with NGI Induction Port



Fixture with FP Induction Port

COPLEY

SPU 200i: User Interface

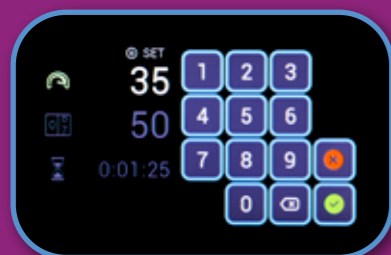

Setting a test parameter



Set v Actual test parameters (before test run)



Set v Actual test parameters (during test run)

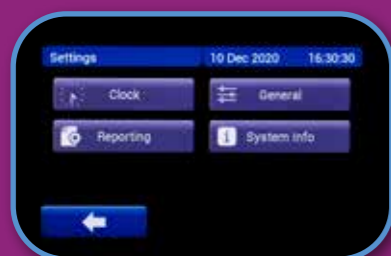

Settings menu

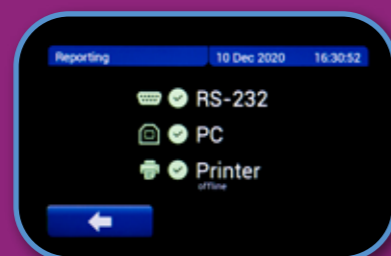

Report output settings menu

SPU 200i: Technical Specifications

Speed:	Variable (20 and 60 rpm (+/- 1 rpm))
Rinsing Cycle Duration:	0 - 120,000 revolutions or 100 hours
Rotational Direction	Fixtures reverse rotation direction half way through run
Connectivity:	RS-232 USB A USB B
Dimensions (w x d x h):	285 x 335 x 295 (with a single Induction Port Fixture) 420 x 335 x 310 (with a single Preseparator Fixture)

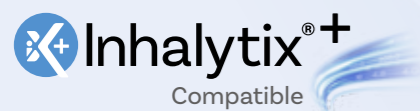

The SPU 200i is compatible with Inhalytix+, enabling instrument metadata and operational parameters to be linked directly to APSD measurement records for improved traceability. See page 218 for more information.

Compliance and Maintenance

- Comprehensive IQ/OQ documentation packages and toolkits available
- Qualification Kit available
- Extended Warranty available

Sample Preparation Unit 200i

Cat. No.	Description
9222	Sample Preparation Unit Model SPU 200i (without Fixtures)
1038	SPU 200i Extended Warranty - 1 year
1039	SPU 200i Extended Warranty - 2 years

Accessories

Cat. No.	Description
9226	Fixture for ACI/NGI/Albuterol & FP Induction Port (each)
8503	Set of 2 Silicone Rubber Rinsing Caps for FP Induction Port
8504	Set of 2 Silicone Rubber Rinsing Caps for ACI/Albuterol Induction Port
9227	Fixture for NGI Preseparator (each)
9232	Fixture for the ACI Preseparator (each)
9228	Fixture for Advanced Filter Holder
5265	Set of 2 Silicone Rubber Rinsing Caps for NGI Induction Port
5266	Set of 2 Silicone Rubber Rinsing Caps for NGI Preseparator
5274	Set of 2 Silicone Rubber Rinsing Caps for ACI Preseparator
9223	IQ/OQ Documentation for SPU 200i
9213	SPU 200i Qualification Tools
9214	Re-calibration of SPU 200i Qualification Tools
9765	Label Printer





Clean your impactor in 4 easy steps:



1. Cleaning
Impactor Ultrasonic Cleaning Bath



2. Rinsing
Impactor Rinse Bath



3. Aspiration
Impactor Suction Aspiration



4. Drying
Impactor Drying Oven



Impactor Cleaning System

Ensuring the thorough, reproducible and controlled cleaning and drying of cascade impactors, the Impactor Cleaning System has been designed to clean component parts of both the NGI and ACI. Regular cleaning and drying are an essential element of good impactor practice. They ensure that the instrument is free of debris prior to testing and that it remains in optimum condition throughout its life.



Available as a complete system, or as individual components



Consistent, reproducible cleaning



Benchtop system



Suitable for both NGI and ACI cleaning

Step 1. Ultrasonic Cleaning Bath

Using ultrasound (usually from 15-400 kHz) to promote the effective cleaning of nozzles and other difficult-to-access places, the Impactor Ultrasonic Cleaning Bath is able to efficiently remove sticky, adhering and embedded particles from solid surfaces.

Step 2. Impactor Rinse Bath

Following cleaning, the impactor parts are normally rinsed in clean cold water and left to drain.

Step 3. Impactor Suction Aspirator

Used to remove the small amounts of excess water that collect in the bottom of the impactor stages and preseparator parts following rinsing and prior to drying, the Impactor Suction Aspirator comprises a hand-held probe linked via a water collection jar to a vacuum pump, which provides the necessary suction.

Step 4. Impactor Drying Oven

Following sonication, rinsing and aspiration, the impactor parts should be dried using a heated cabinet. The Impactor Drying Oven has a temperature range of 25 - 70 +/-1 degrees C, ideal for impactor part drying. Designed to accept 3 individual carrying racks, the unit is fitted with an inner glass inspection door together with a wipe-clean, all stainless-steel interior for ease-of use and cleaning.

The 4-speed forced air circulation means that the oven reacts rapidly to change and is ideally suited to impactor drying, where maximum accuracy and warm-up are required and the door is to be opened on a frequent basis.

Impactor Cleaning System Accessories

Carrying/Wash Racks

The impactor parts are normally placed in a rack prior to immersion (a) to segregate them during the cleaning process and (b) to maximise the surface area exposed to the cleaning process. The Impactor Carrying/Wash Racks are constructed from heavy duty polypropylene and fitted with neoprene cushions to prevent scratching to the outer surfaces of the parts.



NGI Rack

The NGI rack has 12 apertures corresponding to the 8 Collection Cups, NGI Induction Port and the three parts of the NGI Preseparator.

ACI Rack

The ACI Rack has 21 apertures corresponding to the 8 stages, the 8 Collection Plates, the Inlet Cone, Induction Port and the 2 parts of the Preseparator of the ACI.



Storage Cabinet for Impactor Collection Trays

Accommodates up to six NGI Collection Cup Trays / ACI Collection Plate Trays (NGI Collection Cup Trays / ACI Collection Plate Trays not included).

FP/Salmeterol ACI Rack

Available to accommodate the special Induction Port and Preseparator used.

Each rack measures 420 mm (w) x 230 mm (d) and is designed to fit inside the basket used in the Impactor Ultrasonic Cleaning Bath. The basket prevents the carrying rack from touching the bottom or sides of the bath.

Impactor Cleaning System

Cat. No. Description

5400	Impactor Cleaning System (excluding Carrying/Wash Rack)
5205	NGI Carrying/Wash Rack
5401	ACI Carrying/Wash Rack
5401A	FP/Salmeterol ACI Carrying/Wash Rack

Modules Only

5402	Impactor Ultrasonic Cleaning Bath (including basket and lid)
5403	Impactor Rinse Bath
5404	Impactor Suction Aspirator
5405	Impactor Drying Oven
5406	Stainless Steel Drip Tray

Qualification, Servicing & Training

Reliable inhaler testing depends not only on high quality instrumentation, but on the ongoing control, verification and support of the complete testing system. From installation and qualification through routine operation, maintenance and operator training, each element plays a role in ensuring consistent performance and confidence in reported data. Regulatory frameworks such as GMP formalise these expectations, requiring organisations to demonstrate that instruments and associated processes remain fit for their intended use throughout their operational life.

Good Manufacturing Practices (GMP) regulations require that:

- A. The test methods used to monitor pharmaceuticals must meet proper standards of accuracy and reliability
- B. Companies should establish procedures to ensure the fitness for use of instruments that generate data supporting product testing

While GMP defines these obligations, detailed implementation guidance is provided within the pharmacopeias. The United States Pharmacopeia (USP) has addressed this through a series of general chapters, including:

- <1058> Analytical Instrument Qualification
- <1225> Validation of Compendial Procedures
- <1226> Verification of Compendial Procedures
- <1603> Good Cascade Impactor Practices

To provide clarity, USP distinguishes between qualification and validation:

- A. The term “qualification” applies to instrumentation
- B. The term “validation” applies to processes and software

Analytical Instrument Qualification (AIQ) is defined as documented evidence that an instrument performs suitably for its intended purpose. Complementary to this, Analytical Method Validation (AMV) ensures that analytical and software procedures are suitable for their intended application.

In practice, qualification extends beyond individual instruments. Modern inhaler testing frequently involves integrated systems comprising instrumentation, automation and associated software tools, operated by trained analysts following defined procedures. Sustained compliance therefore depends on maintaining validated system performance alongside appropriate servicing and ongoing operator competence, supporting data integrity and reproducibility throughout the instrument lifecycle.

USP Chapter <1058> Analytical Instrument Qualification describes a four phase approach to qualification based on design (DQ), installation (IQ), operational (OQ) and performance (PQ) qualification. Together, these phases provide a structured framework to ensure that inhaler testing systems are correctly specified, installed, verified and maintained in a controlled state throughout their operational life.

It is important to recognise that the purpose of AIQ and its counterpart, AMV, is to establish confidence in the suitability of the instrument and associated procedures before routine testing begins. System suitability tests and quality control checks then provide ongoing assurance of analytical performance immediately before or during sample analysis. In combination, these elements create a layered approach to risk control and performance verification.

The performance of inhaler testing equipment and associated methods may be influenced by factors other than the instrument itself. Source of variability can be broadly categorised as:

- **Analytical factors**, including operator technique and procedural deviation
- **Instrument related factors**, including performance drift of instruments and ancillary equipment

A robust inhaler testing strategy recognises that both sources must be controlled to ensure reliable and reproducible results. Minimising variability therefore requires more than instrument qualification alone. It involves the coordinated application of:

By combining these elements, laboratories can maintain a controlled testing environment in which variability arising from equipment and human factors is reduced. When these sources of error are effectively managed, any anomalies in results are more likely to reflect the true behaviour of the device and formulation under investigation rather than deficiencies in the testing system itself.

Copley recognises the scientific and regulatory importance of this structured approach. Our portfolio of products, services and documentation is designed to support laboratories throughout the OINDP testing lifecycle, helping to maintain sustained system performance, data integrity and regulatory compliance.

- Qualification Services**
See page 324
- Product Protection Plans**
See page 333
- Support**
See page 334
- Training**
See page 335

Qualification Services

Impactor Qualification

Stage and Components Mensuration

Both the Ph. Eur. and USP define criteria that cascade impactor systems and associated methods must fulfil prior to and during use. Compliance with these requirements is essential to ensure that aerodynamic particle size distribution data are accurate, reproducible and representative of true product performance.

The performance, repeatability and reproducibility of a cascade impactor depend on several critical factors. Among the most significant are the nozzle dimensions and their spatial arrangement on each stage, together with the controlled air flow rate passing through the system. When these parameters remain within the defined pharmacopoeial specifications, comparable and reliable results can be achieved.

The process of measuring the nozzle diameters and other critical dimensions of cascade impactors is known as impactor mensuration. Both the Ph.Eur. and USP recommend the stage mensuration of impactors prior to use and periodically thereafter.

In routine laboratory use, impactors may be exposed repeatedly to formulations and recovery solvents. Over time, this can lead to corrosion, wear or partial occlusion of nozzles, particularly in aluminium components. Such changes may alter stage aerodynamics and particle collection characteristics, potentially affecting reported data if not identified and controlled.

Stage mensuration provides a structured and documented means of verifying that impactor stages conform to the critical dimensions defined in USP Chapters <601> and <1603> and Ph.Eur. Chapter 2.9.18. By confirming dimensional compliance, mensuration

supports the continued suitability of the impactor for use and reduces the risk of undetected performance drift.

Beyond simple dimensional assessment, regular mensuration establishes a record of component condition over time. This enables laboratories to monitor wear patterns, plan maintenance proactively and maintain confidence in the aerodynamic performance of their testing systems throughout the impactor lifecycle.

Copley provides a dedicated mensuration service for all types of Ph.Eur. and USP specified impactors, including induction ports and preseparators. All certificates are supplied electronically, supporting clear documentation, traceability and audit readiness.



Mensuration Certificate



Mensuration of ACI Stages using the Mitutoyo QV404 Vision Inspection System

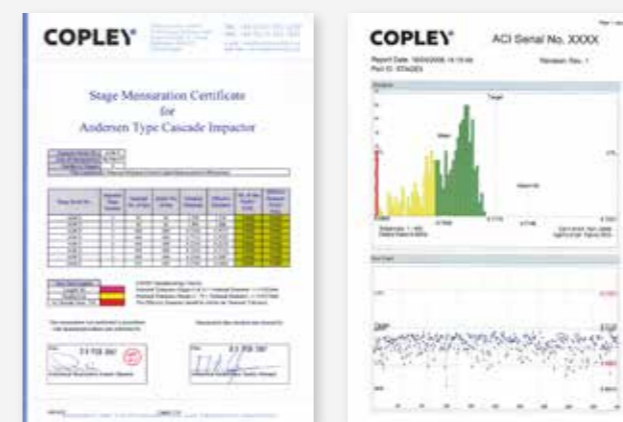

Stage Mensuration Certificate with Histogram Option

Mensuration certificates are supplied as standard with all new impactors, preseparators and induction ports, confirming conformity with pharmacopoeial dimensional requirements.

As impactors enter routine use, periodic re-mensuration, typically at least annually, provides documented confirmation of continued “in-use” compliance.

Data Interpretation

Copley adopts Effective Diameter (ED) and In-Use Margin as recognised by the European Pharmaceutical Aerosol Group (EPAG) to assess the suitability of cascade impactors throughout their operational life.

Derived from the area-mean and area-median diameters of multi-nozzle impactor stages, ED is a useful parameter that can be used to monitor “drift” in the D50 of impactor stages (median nozzle diameter). Rather than relying solely on nominal dimensions, ED reflects the cumulative condition of the stage and provides a meaningful performance indicator.

The In Use Margin expresses the remaining percentage of pharmacopoeial tolerance relative to the measured ED. An ED equal to the nominal stage diameter corresponds to a 100 percent In Use Margin, while an ED approaching the upper or lower tolerance limit reduces the remaining margin. If ED falls outside compendial tolerance, the In Use Margin becomes negative, indicating loss of compliance.

Successive mensuration reports enable the tracking of changes in Effective Diameter and In Use Margin over time. This trend based approach allows laboratories to monitor component wear, assess the rate of deterioration and anticipate when remedial action may be required. By identifying progressive drift before a stage reaches an out of specification condition, maintenance or replacement can be planned proactively, reducing the risk of unexpected non-compliance and disruption to testing activities.

This structured, data-based monitoring supports sustained aerodynamic performance, provides a clear audit trail and reinforces confidence that impactor systems remain suitable for their intended use throughout their lifecycle. remedial work will be required.

TOP TIP

Continuous improvements in NGI manufacturing processes, including refinements to Stage 5 production, have resulted in tighter control of Effective Diameter across all nozzles. While every NGI has always conformed to pharmacopoeial specifications (heavy black lines), current manufacturing controls ensure that ED values consistently fall within a narrower proportion of the allowable tolerance range (heavy blue lines).

This enhanced dimensional consistency supports improved reproducibility of aerodynamic performance, reduces variability between units and reinforces confidence in long term system reliability. These data reflect Copley's ongoing commitment to precision engineering and sustained quality improvement.

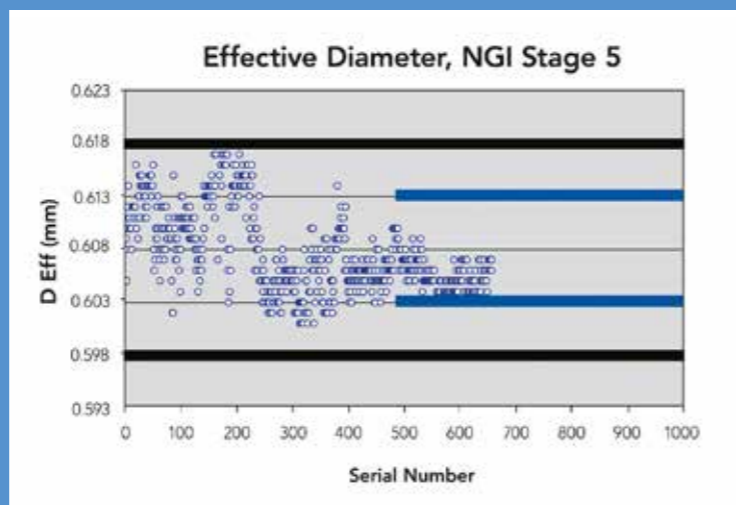

Impactor Performance Restoration

Following impactor mensuration, three outcomes are possible:



Effective Diameter within specification

When mensuration confirms that Effective Diameter remains within pharmacopoeial specification, no corrective action is required and the stage may continue in routine use under controlled conditions.



Effective Diameter in excess of an upper limit

If Effective Diameter exceeds the upper tolerance limit, this typically indicates irreversible wear of the nozzles. Such wear may result from corrosion caused by recovery solvents or erosion due to prolonged particle passage. Because material cannot be re-applied to restore original dimensions, stage replacement is required to return the impactor to a compliant and validated state.



Effective Diameter below the lower limit

More commonly, impactors drift below the lower tolerance limit due to partial occlusion of nozzles. This may arise from accumulation of hardened particulates or corrosion by-products that reduce the effective nozzle diameter. In these cases, controlled restoration may be feasible.

Rigorous cleaning procedures, including the use of validated ultrasonic cleaning systems (see page 320 for the Impactor Cleaning System), can remove deposits and restore nozzle dimensions. Where appropriate, **stage pinning** may be undertaken using calibrated stainless steel “go” pins with diameters between the nominal value and the lower tolerance limit. This controlled process is designed to remove occlusions while preserving critical dimensional integrity.

Following any restoration activity, re-mensuration confirms whether the stage has been successfully returned to specification. Where restoration is not achievable, stage replacement is recommended to maintain compliance and aerodynamic performance integrity.

By applying documented decision criteria and structured restoration pathways, laboratories can maintain impactor performance in a controlled manner, minimise unexpected non compliance and protect the continuity of validated testing operations.



Pinning various stages of the ACI



Pinning Kit with close-up of Pin

Impactor Mensuration Services

Cat. No.	Description	Cat. No.	Description
8590	Induction Port Mensuration	5290	NGI Stage Mensuration
8390	ACI Stage Mensuration	5291	NGI Preseparator Mensuration
8990	60 L/min Conversion Kit Mensuration	8591	Alberta Idealised Throat Mensuration
5236	90 L/min Conversion Kit Mensuration	8340	FSA Stage Mensuration
8490	ACI Preseparator Mensuration	5270	FSI Insert Mensuration
8311	ACI Stage Mensuration Histogram (per stage)	8917	GTI Mensuration
8890	MSLI Stage Mensuration and Leak Test		

Mensuration 'Returns' Boxes

5292	NGI Seal Body Mensuration 'Returns' Box
5297	Replacement NGI Carton

Leak Testing

5233	ACI or NGI Leak Test Certificate
5234	ACI or NGI Delta-P Certificate
5251A	Re-calibration of LTK2 Leak Test Kit tools

Pinning Kits and Services

5430	ACI Pinning Service (per stage)
5431	ACI Pinning Kit
5432	NGI Pinning Service (per stage)
5433	NGI Pinning Kit

Servicing & Calibration Services

Maintaining validated system performance requires more than initial qualification. Routine servicing, calibration and periodic verification are essential to ensure that inhaler testing equipment continues to operate within defined and documented parameters throughout its operational life.

Copley provides structured lifecycle support tailored to the needs of individual laboratories, helping to sustain compliance, minimise unplanned downtime and protect the integrity of both standalone and integrated testing systems.

Comprehensive Lifecycle Support Includes:



Qualification & Requalification

- On-site IQ/OQ and requalification support
- Verification of system performance following installation, relocation or major service
- Documentation prepared and completed in accordance with GxP requirements



Servicing & Calibration

- In-house servicing and calibration
- On-site servicing and calibration
- Performance verification of critical instruments and ancillary components
- Calibration support for flow control and automated systems



Structured Support Options

- Preventative maintenance service agreements
- One-off technical interventions
- Dedicated account management for coordinated service delivery

Our qualified engineers and technicians are trained to a high standard and operate in accordance with documented procedures, ensuring that all servicing activities are performed in a controlled and compliant manner.

Service agreements provide a proactive approach to maintaining validated system status. By planning maintenance and calibration activities in advance, laboratories can reduce the risk of unexpected performance drift and maintain continuity of testing operations across complete inhaler testing systems.

All servicing and calibration activities are fully documented to regulatory standards, providing clear evidence of ongoing control and supporting audit readiness.

We will be pleased to discuss your individual requirements. Please contact us at sales@copleyscientific.co.uk

Qualification Tools and Documents

IQ/OQ Documentation

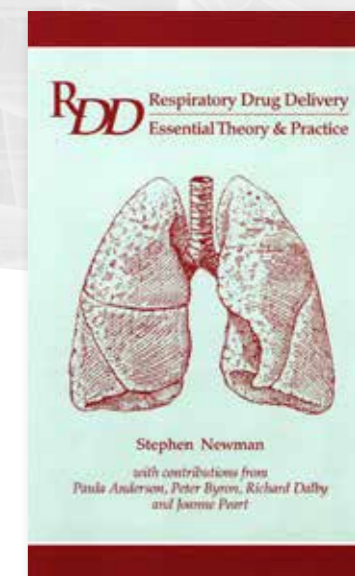

According to USP Chapter <1058>, Analytical Instrument Qualification is defined as the documented evidence that an instrument performs suitably for its intended purpose. Demonstrating this suitability requires a structured and repeatable approach to system level qualification.

While stage mensuration confirms dimensional conformity of individual impactor components, it does not in itself qualify the complete inhaler testing system. Full system qualification requires documented verification that all instruments, ancillary equipment and associated components operate together as intended.

Copley's IQ/OQ documentation provides a comprehensive framework to guide users through Installation Qualification and Operational Qualification procedures. These documents define the scope of qualification, outline test plans and reference standard operating procedures to ensure consistent and controlled execution.

Documentation packages typically include:

- **Master Plan**
 - Defining the aim and scope of the qualification.
- **Installation Qualification**
 - Outlining the test plan, the standard operating procedures and test protocols necessary to perform the IQ for the system concerned.
- **Operational Qualification**
 - Outlining the test plan and the standard operation procedures and test protocols to perform the OQ of the system concerned.

By following a structured IQ/OQ process, laboratories can establish and document validated system status, supporting regulatory compliance and audit readiness.

Qualification Documents

Cat. No.	Description
8000	IQ/OQ Documentation for Inhaler Testing Systems
9500	Respiratory Drug Delivery Essential Theory & Practice Book

Individual ancillaries and automation IQ/OQ documentation can be found in the relevant sections

Qualification Tools



Inhaler Testing Qualification Kit ITQK2

Copley's Inhaler Testing Qualification Kit (ITQK2) includes the calibrated tools required to perform IQ/OQ procedures and to verify the performance of key system components. The kit may also be used to support calibration activities for Copley flow controllers and related equipment.

By providing defined tools alongside documented procedures, the qualification process can be conducted in a consistent and controlled manner, reducing variability and supporting reliable system verification.

In addition to the Inhaler Testing Qualification Kit, the following qualification kits are available for the following products:



Breathing Simulator
BRSi Series - Page 156



Facemask Apparatus
FMA - Page 250



NGI Cooler™
Page 202



EnviroMate™
Page 196



Patient Exhalation Simulator PES - Page 280



Spray Force Tester
SFT 1000 - Page 262



DUSA Shaker™ DTS 100i
Qualification Tools - Page 306



Impactor Coater™
IC 200i - Page 308



Gentle Rocker™ GR 100i
Page 310



Impactor Genie™ IG 200i
Page 312



Sample Preparation Unit
SPU 200i - Page 314



Vertus® III
Page 292



DecaVertus® III
Page 298

Qualification Tools

Cat. No.	Description
5440	Inhaler Testing Qualification Kit Model ITQK2
5445	Re-calibration of ITQK2 Kit tools
5207	NGI Leak Tester

Product Protection Plans

Standard 12 Months Warranty

Copley offers a 12 months supplier's warranty as standard across our entire product range.

Extended Product Protection

To support extended operational assurance, selected products are eligible for additional Product Protection Plans, offering coverage for a further 12 or 24 months beyond the initial warranty period. We have confidence in our excellent product quality but an extended protection plan provides the peace of mind that comes with an added layer of assurance.

Products that extended product protection plans are available for:



Flow Controllers
See page 172



Vacuum Pumps
See page 188



Breathing Simulators
See page 156



Automation Tools
See page 286

By extending coverage beyond the standard warranty period, laboratories can plan with greater confidence, manage risk proactively and maintain sustained system performance throughout the equipment lifecycle.

We would be pleased to discuss available protection options and help determine the most appropriate level of coverage for your operational needs.

Support

Reliable inhaler testing depends not only on qualified equipment, but on timely access to technical expertise throughout the operational life of the system.

Copley's support structure provides coordinated access to trained distributors, field service engineers and central technical specialists, ensuring that assistance is both responsive and technically robust. From initial installation through routine operation and system optimisation, our approach is designed to maintain performance continuity and regulatory confidence.

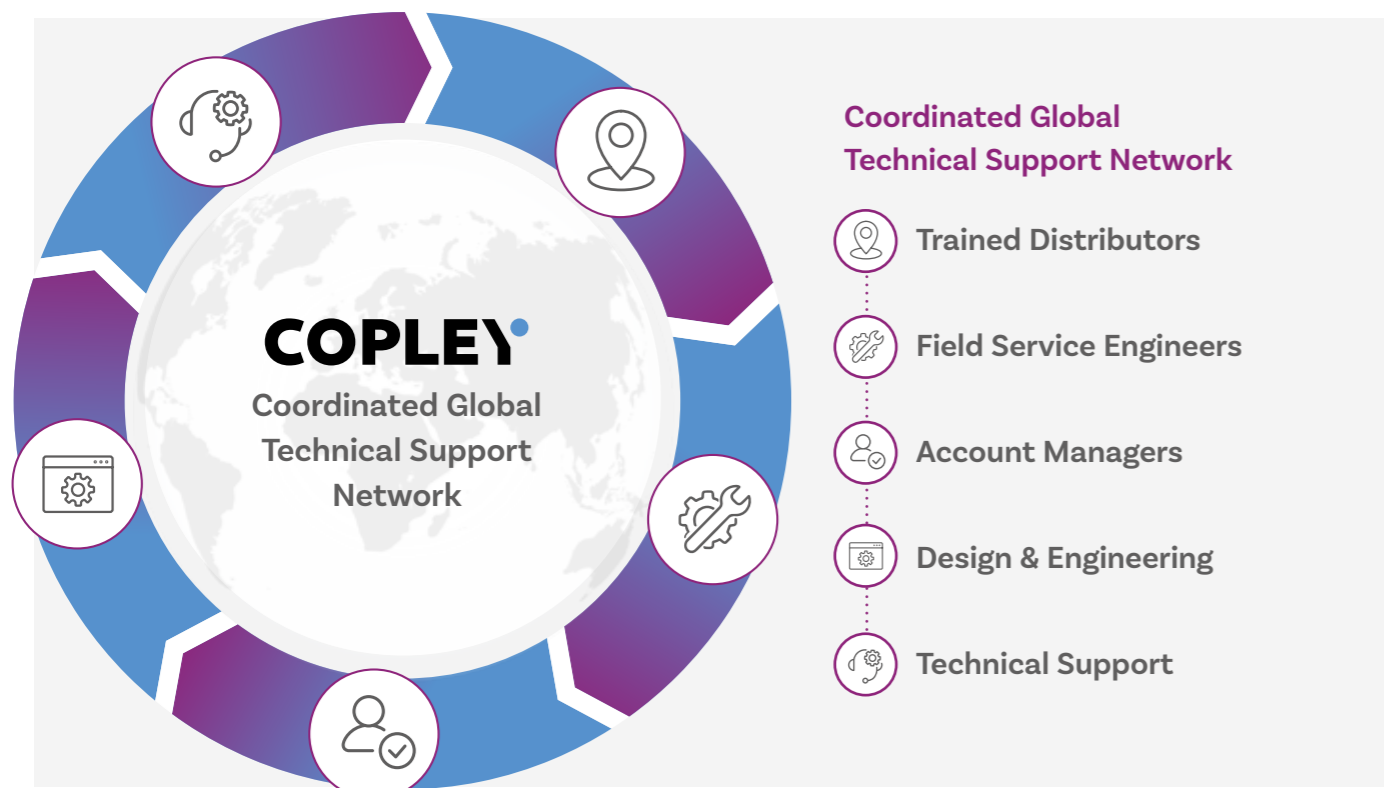

All customer enquiries are supported through a coordinated technical structure, ensuring access to product specialists, engineering expertise and qualified service personnel.

Need support? Start by contacting our technical team directly.

We will coordinate the appropriate regional or specialist support for you.

Email: sales@copleyscientific.co.uk

Tel: +44 (0)115 961 6229

Training Services



Reliable inhaler testing depends not only on properly qualified systems, but on operators who understand how to use them correctly. Structured training helps ensure validated methods are applied consistently, reduces the risk of human error and supports regulatory compliance.

As a world leader in inhaler testing equipment, Copley provides tailored training programmes designed for analysts, laboratory managers and technical specialists working across OINDP development, manufacturing and testing environments.

Bespoke Customer Training

For laboratories requiring targeted support, bespoke training programmes can be developed to address specific systems, workflows or internal procedures. Training may be delivered on-site, remotely or at Copley facilities and can be aligned with qualification or servicing activities to reinforce best practice and system understanding.

Programmes may support:

- Induction training for new analysts
- Standardisation of test method execution
- Refresher training linked to IQ/OQ or maintenance activities
- Optimisation of testing workflows



Our **Inhaler Testing Academy** offers intensive group training designed to provide a clear grounding in regulatory expectations, testing fundamentals and the practical application of core *in vitro* methods. Suitable for both new and experienced analysts, courses combine structured lectures with practical demonstrations to reinforce understanding and application.

Example topics include:

- Regulatory expectations for inhaler testing
- *In vitro* testing methods for MDIs, DPIs, nebulisers, SMIs and nasal products
- Improving the clinical relevance of *in vitro* test methods

The Academy also provides an opportunity for peer learning and industry networking within a focused technical environment.

For information on upcoming Inhaler Testing Academy sessions, please contact sales@copleyscientific.co.uk

Book your training course.

- ✓ Highly experienced trainers
- ✓ Bespoke training programs
- ✓ On-site training available
- ✓ Certification provided

Please contact us to find out more about our range of training options.

Contact us at: sales@copleyscientific.co.uk
or call: +44 (0)115 961 6229



To learn more about the full Academy offering, scan the QR code to view the brochure.

Index

A

Abbreviated Impactor Measurement (AIM)	265-271
ACI	79, 90-95
ACI Carrying/Wash Rack	94, 322
ACI, Cleaning	320-323
ACI Cleaning System	320-323
ACI Collection Plate Rack	93, 95
ACI Drying Oven	321, 323
ACI Pinning Kit	328-329
ACI Pinning Service	328-329
ACI Rinse Bath	321
ACI Sample Preparation Unit	314-319
ACI Suction Aspirator	321
ACI Ultrasonic Cleaning Bath	320, 323
Active Pharmaceutical Ingredient (API)	8, 80
Active Substance Delivery Rate (Nebulisers)	52, 53
Actuation Sensor for MDIs	179
Adapters, Mouthpiece	214-216
Adapters, Nosepiece	214, 216
Add-on Devices	7, 40-44, 111-116
Advanced Filter Holder	25, 31, 42, 43, 53-55, 235-236, 317, 319
Aerodynamic Particle Size (APSD)	13, 78-153
AIM - HRT Model	265-271
AIM - QC Model	265-267
Alberta Idealised Nasal Inlet (AINI)	234, 238, 240
Alberta Idealised Throat (AIT)	232-233, 238
Albuterol Aerosols, Testing	31, 278-279
Analytical Instrument Qualification (AIQ)	324-325
Analytical Method Validation (AMV)	324-325
Ancillaries	156-217
Andersen Cascade/Impactor (ACI)	90-95, 241
Andersen Fast Screening Impactor (FSA)	267-268
Antistatic Grounding Kit	200
Aerodynamic Particle Size Distribution (APSD)	13, 78-153
APSD Drug Recovery	288, 302, 310, 312
Aqueous Droplet Inhalers	6, 10, 58-62, 130-135
Auto Flow Control	287, 290-297
Automated Cup Coating	288, 308-309
Automated Drug Recovery	287-289, 302, 306, 310, 312, 314
Automated Fire	287, 290-297
Automated Flow Control	172-183
Automated Nasal Testing System	26, 29, 65, 137, 142, 287
Automated Shake	287, 290-297
Automated Shake and Fire	287, 290-297
Automation	286-323
Automation (MDI)	290-301
Automation (NGI)	302-305, 308-313

B

Book, Reference	331
Breath Actuation Controller BAC 100i	176-179
Breath-Actuated MDIs	7, 20, 21, 104, 172
Breathing Simulators	25, 154, 156-171
Bounce, Particle	96, 104, 118, 296
BP Content Uniformity Apparatus	25

C

Caps, Rinsing	88, 89, 94, 95, 315, 319
Carrying/Wash Rack ACI	94, 332
Carrying/Wash Rack, NGI	88, 89, 322, 323
Cascade Impactors	79-83, 84-103
Cascade Impactor Preparation	288, 308, 312
CDER	12, 16, 17
CDRH	12
Chinese Pharmacopoeia (ChP)	16, 17
Cleaning Systems, ACI/NGI	320-323
Coarse Particle Mass (CPM)	266, 268, 270
Coating, Cups	104, 118, 122, 288, 308-309, 312
Cold Freon® Effect	261
Collection Tubes for DPIs	22-23
Collection Tubes for MDIs	21
Connectors, Quick-Release	207
Conversion Kits, 60 & 90 L/min	95
Cooler, NGI	202-203
Critical Quality Attributes (CQAs)	15, 18, 78, 228
Critical (Sonic) Flow	174, 180, 191
Cup Coater	308-309
Cut-Off Diameter	86, 90, 92, 98, 266, 267, 270
Cup Tray Storage Cabinet, NGI	313, 322

D

Data Analysis Software (Inhalytix)	218-225
DecaVertus® III	298-301
Delivered Dose Sampling Apparatus for:	
- Nebulisers with a Mouthpiece	52-55
- Nebulisers with a Facemask	252-253
- Spacers & VHCs	40-43
Delivered Dose Uniformity (DDU)	18-76

D

Device Misuse	280
Device Resistance	18, 182, 227
Device Robustness	280-281
Dissolution Cup	248
Dissolution Inhaled	243-249
Dissolution Testing	242-249
Dosage Unit Sampling Apparatus (DUSA) for DPIs	22-23
Dosage Unit Sampling Apparatus (DUSA) for MDIs	21
Dosage Unit Sampling Apparatus (DUSA) for Nasal Sprays, Aerosols and Powders	26
Drop Test Apparatus	282-283
Drug Delivery Devices	6-11
Drug Delivery, PES	280-281
Drug Dissolution	302-305, 310-311, 312-313
Drug Losses, Inter-Stage	85, 96, 98
Drug Recovery	298, 300, 302
Drying Oven, ACI	321
Dry Powder Inhalers (DPIs)	8
DUSA Shaker™	289, 306-307

E

Effective Cut-off Diameter (ECD)	92
Efficient Data Analysis (EDA)	265
Electrostatic Effects	195
Electrostatic Eliminator	200
Emitted Dose	18
Entire Contents (DDU)	19, 20, 33, 41, 47
Environmental Control Chamber	196-200
Environmental Variability	196, 198
European Medicines Agency (EMA)	12, 14, 17
European Pharmaceutical Aerosol Group (EPAG)	16, 17, 203, 327
European Pharmacopoeia (Ph.Eur.)	15
External Filter Holder, NGI	87, 89, 127, 270, 303, 304

Extra-fine Particle Mass (EPM)	222, 266, 268, 269
--------------------------------	--------------------

F

Facemask-based products	226, 229, 250-259
Facemask Stand for Nebulisers (FMS)	256-259
Facemask Test Apparatus for Spacers and VHCs (FMA)	252-255
Fast Screening Andersen (FSA)	267
Fast Screening Impactor (FSI)	270-271
Fast Screening Impactors	267-271
Fast Screening NGI (rNGI)	269
Flow Rate Sensor FRS	185, 186

F

Fine Particle Dose (FPD)	78, 82, 100, 141, 147, 219-222, 277
Fine Particle Mass (FPM)	266, 268, 270-271
Flow Controllers:	
- TPK-100i	180-183
- TPK 100i-R	180-183
- BAC 100i	176-179
- BAC 100i-R	176-179
Flow Rate Measurement	184-187
Flow Rate	173, 184, 185
Flow Rate Sensor	185, 186
Flow Rate Stability	174
Flow Resistance	22, 46, 48, 90, 183, 187, 228, 264, 272
Fluticasone Propionate Aerosols	
- Testing	275
Fluticasone Propionate Powders	
- Testing	275-276
Food and Drug Administration (FDA)	12, 13, 14, 16, 17

G

Generic Drug Development	274-277
Glass Expansion Chambers	208-210
Glass Impinger	100-102
Glass Twin Impinger	100-102
Gentle Rocker	310-311
Geometric Standard Deviation (GSD)	82, 84, 219, 222
Global Harmonisation Task Force (GHTF)	14
Gravimetric Cup, NGI	87, 89

H

Relative Humidity, EnviroMate™	196, 197, 198
--------------------------------	---------------

I

ICH Guidelines	14
Idealised Nasal	234
Idealised Throat	232-233
Impactor Choice	103
Impactor Cleaning System	320-323
Impactor Performance Testing	320-323
Impactor Preparation	308-311
Impactor Qualification	324-329
Impactor Sized Mass (ISM)	222, 232, 265-266
Impinger, Glass, Twin	100-102
Inhaled Dissolution	242-249
Inhaled Dissolution Apparatus™ IDA	243-247
Inhaled Drug Products	6-11
Inhaler Misuse	264, 280, 282
Inhaler Testing Academy®	335
Inhaler Testing Software (Inhalytix®+)	218-225
Inhaler Testing Workstation (ITW)	204-207
Inhalytix®+ Software	218-225
Inlet, Mixing	234, 238
Inspiration Volumes	173, 174

I

Installation Qualification	331
Internal Filter Holder, NGI	89
International Pharmaceutical Consortium on Regulation and Science (IPAC-RS)	16, 17
International Standards Organisation (ISO)	2, 14, 16, 17
Inter-Stage Losses	85, 96, 100
<i>In vitro</i> - <i>in vivo</i> correlation	14, 81, 156, 157, 226-229
In-Use Margin	327
IPAC-RS	16, 17
IQ/OQ Documentation	331
ISO 20072	16, 17
ISO 27427:2013	17, 158, 162, 167
ISO 9001:2015 Quality Management System	2
ITW	204-207
IVIVC	14, 81, 156, 157, 226-263

J

Japanese Pharmacopoeia (JP)	16, 17
Jet Nebulisers	9

K

Kiel Nasal Inlet KNI	212
----------------------	-----

L

Label Printer	161, 179, 183, 247, 293, 297, 299, 304,
Large Particle Mass (LPM)	222, 265
Leak Testing	21, 83, 176, 180, 291, 329
Leak Test Kit	329
Losses, Inter-Stage	85, 96, 100
Losses, Wall	84

M

Mass Balance	84
MDI Actuation Sensor	34, 42, 105, 112, 158, 179, 183
MDI Angle of Rotation	296, 300
MDI Automation	290-301
MDI Shake and Fire	287, 290-301
Measurement, Flow Rate	184-187
Mensuration (impactor)	83, 312-315
Mesh Nebulisers	9
Meter, Static	200
Metered-Dose Inhalers (MDIs)	7, 32-44, 104-116
Metered Nasal Spray Pump	10
MHLW (Japan)	12, 14
Mitutoyo QV404 Vision Inspection System	327
Mixing Inlet	234, 238
Mouthpiece Adapters	214-216
Multi-Stage Liquid Impinger (MSLI)	96-98

N

Nasal Aerosols	10, 68-71, 141-146
Nasal Delivery Systems	10
Nasal, Idealised	234, 238, 240
Nasal Device Holder	26-206
Nasal Powders	10, 72-76, 147-152
Nasal Spray Dose Collector	27-29
Nasal Spray Modification, Twin Impinger	100, 101
Nebulisers	9, 52-56, 124-129
Nebulisers, Delivered Dose	52-56
Nebulisers, Particle Size	124-129
Next Generation Impactor (NGI)	84-89
NGI	84-89
NGI +	85, 89
NGI Carrying/Wash Rack	88, 308
NGI Cooler™	127, 133, 155, 199, 202-203
NGI Cup Coater	288, 308-309
NGI Cup Tray Storage Cabinet	313
NGI Gentle Rocker	310-311
NGI Gravimetric Cup	87, 89
NGI Leak Tester	322
NGI Pinning Kit	329
NGI Pinning Service	329
NGI Plus	85, 89
NGI, Reduced (rNGI)	265
NGI Sample Preparation Unit	280, 314-319
NGI Ttilting Platform	284-285
Nosepiece Adapters	214-216
NSDC	27, 28, 29

O

OINDPs	6-11
Operation Qualification	326
Organisations	12-17

P

P1 Measurement Adapter	120
Particle Bounce	96, 104, 118, 296
Particle Size	78-83
Patient Breath Profile	156, 157, 158-171
Patient Exhalation Simulator, PES	280-281
PES	280-281
Pharmacopoeial Forum	15
Pharmeuropa	15
Ph.Eur.	15
Pinning Kits	329
Pinning Service	329
Powder-Based Nasal Devices	10, 72-76, 147-152
Pressure Drop	22, 42, 46, 72, 92, 118, 120, 173
Process Analytical Technologies (PAT)	14
Product Quality Research Institute (PQRI)	16

COPLEY

Copley Scientific Limited

Colwick Quays Business Park, Road No.2
Nottingham, NG4 2JY
United Kingdom

+44 (0)115 961 6229

sales@copleyscientific.co.uk

copleyscientific.com



Certificate Number 7391